

[www.biobidet.com](http://www.biobidet.com)

## **BBC Innovation Corporation**

Head office:

205 Berg St

Algonquin, IL 30102

U.S.A

Tel: (847) 854-7292

Fax: (847) 854-1296

**Installation Manual and  
Operating Instructions**

..... BB-800 & BB-1000

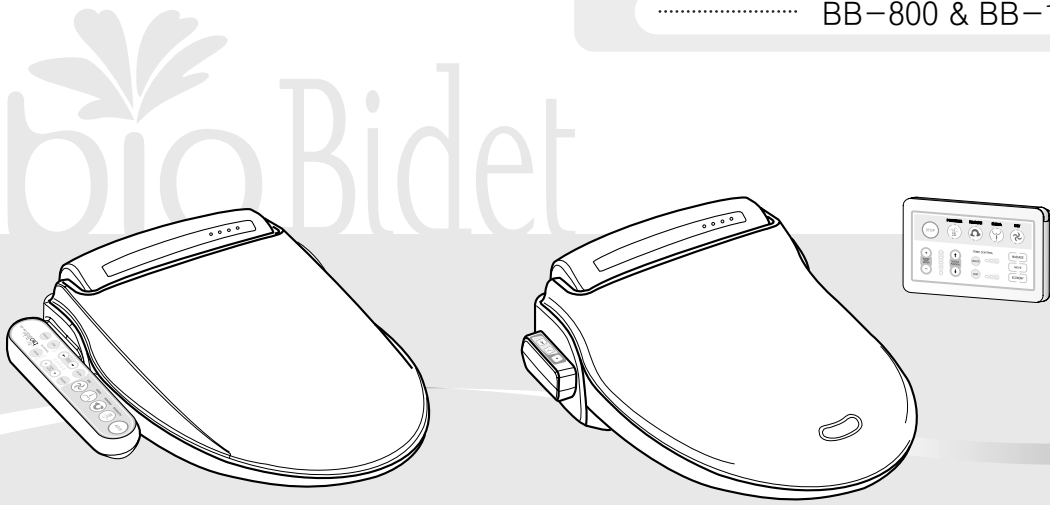

- This Product should be installed according to this manual.
- Please read this manual carefully and install properly.
- Please keep this manual for future reference.
- Please register Warranty for proper service.

bioBidet

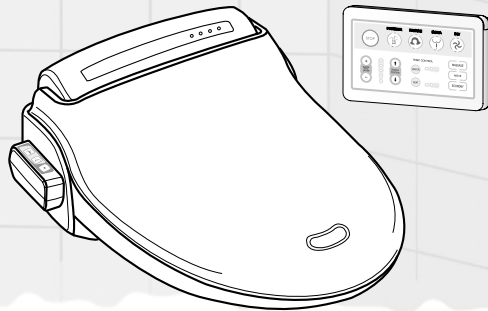
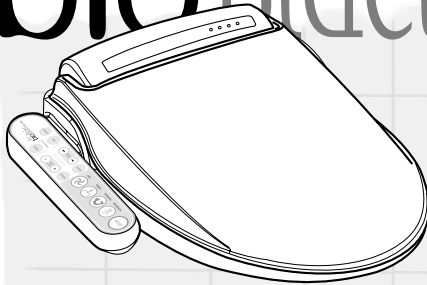

Thank you for purchasing Bio Bidet Advanced Toilet Seat  
This unit was manufactured for household use.

# Contents

- IMPORTANT SAFEGUARDS / ..... 4
- GENERAL CAUTIONS
- CAUTIONS BEFORE INSTALLATION ..... 6
- CARTON CONTENTS / IDENTIFICATION ..... 8

**PREPARATION**

- OPERATION (BASIC) ..... 9
- OPERATION (DETAILS) ..... 10

**OPERATION**

- INSTALLATION ..... 14
- SEPARATION OF THE UNIT FROM  
THE TOILET BOWL ..... 17

**INSTALLATION**

- MAINTENANCE ..... 18
- WATER DRAINING ..... 19
- TROUBLE SHOOTING ..... 20
- SPECIFICATIONS ..... 21
- WARRANTY ..... 22
- INFORMATION TO THE USER ..... 23

**MAINTENANCE**

# 1 IMPORTANT SAFEGUARDS / GENERAL CAUTIONS

## ● READ ALL INSTRUCTIONS BEFORE INSTALLATION AND USE

The following terms are used in this manual to indicate hazards of varying degrees of severity

<b>DANGER</b>	Indicates an imminently hazardous situation which, if not avoided, will result in death or serious injury.
<b>WARNING</b>	Indicates potentially hazardous situation which, if not avoided, could result in death or serious injury.
<b>CAUTION</b>	Indicates potentially hazardous situation which, if not avoided, may result in minor or moderate injury or in damage to the product or other property.



**DANGER** – To reduce the risk of electrocution



**WARNING** – To reduce the risk of burns, electrocution, fire, or injury to persons



**PLEASE OBSERVE THE FOLLOWING PRECAUTION BEFORE USING THIS PRODUCT**



Do not dismantle

Do not open the product to repair or remodel.  
Only qualified service personnel should service this product.  
Do not use attachments not recommended by the manufacturer.



Prohibited

Connect this product to cold water supply pipe carrying potable water.  
Do not connect to an industrial water supply line that does not carry water of drinking quality.  
This will negatively effect hygiene and performance.

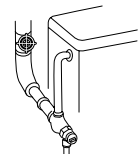

Prohibited

### About Low Temperature Burns–

A burn occurs when the skin has been exposed to high temperatures. However, a low temperature burn may occur when the skin has been in contact with an object at relatively low temperature (about 104 °F). Close supervision is necessary when this product is used by children or adults with sensitive skin.



Prohibited

If using any chemical toilet bowl cleaner, be sure to wipe up any spills that splash onto Electric Bidet.  
Do not use benzene or any acid chemical detergent.  
Only neutral detergent permitted.





Prohibited

Do not plug in the power cord before connecting the water supply hose.

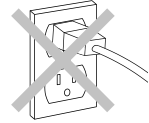

Grounding

This product must be grounded.  
An approved Ground Fault Circuit Interrupt, must be used.



Do not spray water

Do not splash water on this product. Please provide adequate ventilation to avoid damage to electronic components due to high level of humidity. It is necessary to provide adequate ventilation with a fan, open door or open window when bathing.

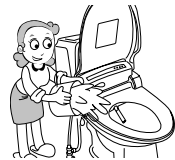

Wet hands prohibited

Do not touch the power cord with wet hands.  
Do not reach for a product that has fallen into water.  
Unplug immediately!

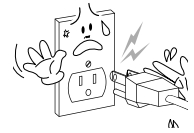

Observe at all times

This product must be connected to a standard voltage power source. Do not connect power cord if the cord is damaged or broken. Do not plug the unit into a loose electric outlet.



Observe at all times

Please disconnect the power cord when you clean this product or detach it from toilet bowl. Do not supply electrical power to the unit until the plumbing work has been completed.

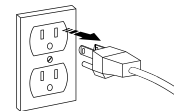

Use of fire prohibited

Keep the electrical cord away from heated surfaces to prevent a fire hazard. Also, keep any flammable materials away from this product at all times.





## CAUTION



Prohibited

Never operate this product if it is not working properly, if it has been dropped or damaged, or dropped into water. Return the product to a service center for examination and repair.



Prohibited

Do not obstruct or put anything into the dry air outlet. Do not apply excessive force to the shower nozzle.



Prohibited

Do not stand or sit on the seat cover lid. It is not designed to support a user's body weight.



Prohibited

Allow the seat and lid to close automatically do not force the closed.



Prohibited

Do not strain or push the connected hose and tube connector; it may cause water leakage. Never drop or insert any object into any opening or hose. Use proper plumbing supplies if any modification is to be made.

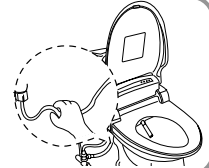

Observe at all times

Use this product only as described in the operating instructions. Never use while sleeping or drowsy. Do not use while bathing.



Observe at all times

Be careful so that this product does not become stained with excrement and urine.



Observe at all times

Drain the water from unit and unplug the power if it is not going to be used for an extended period of time. Refer to page 19

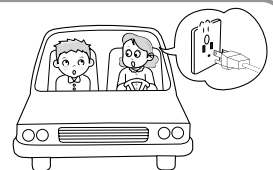

– SAVE THESE INSTRUCTIONS –

## 2

## CAUTIONS BEFORE INSTALLATION

### WIRING REQUIREMENT

THIS PRODUCT MUST BE PLUGGED into a regular voltage Grounded GFCI outlet (North America 120V ac, 60Hz / Europe 220–240V~, 50/60Hz). The rated power consumption is 660W / 600–700W. In locations where only a standard two-prong outlet is available, it is the responsibility of the user to install a grounded three-prong outlet. Using a higher voltage is dangerous and may result in a fire or other accident. This product is not responsible for damage resulting from the use of it on other than specified voltage, or operating it without proper grounding.

**⚠ WARNING**

This Product must be on a separate circuit. No other appliance should share the circuit with this product. Sharing a circuit could cause the branch circuit fuse to blow or the circuit breaker to trip. Continuous usage under these conditions could result in fire or property damage.

**GROUND INSTRUCTIONS**

- (1) This product has a three-prong grounding plug, which must be plugged into an outlet that is properly installed and grounded. In the event of an electrical short circuit, grounding reduces the risk of electric shock by providing an escape wire for the electric current. If repair or replacement of the cord or plug is necessary, do not connect the grounding wire to either flat blade terminal. The wire with insulation having an outer surface that is green with or without yellow stripes is the grounding wire. Check with a qualified electrician or serviceman if the grounding instructions are not completely understood, or if in doubt as to whether the product is properly grounded.
- (2) This product is for use on a nominal 120V circuit, and has a grounding plug that looks like the plug illustrated in sketch A in Figure 1. A temporary adapter, which looks like the adapter illustrated in sketches B and C, may be used to connect this plug to a 2-pole receptacle as shown in sketch B if a properly grounded outlet is not available. The temporary adapter should be used only until a properly grounded outlet (sketch A) can be installed by a qualified electrician. The green colored rigid ear, lug, or the like extending from the adapter must be connected to a permanent ground such as a properly grounded outlet box cover. Whenever the adapter is used, it must be held in place by the screw.

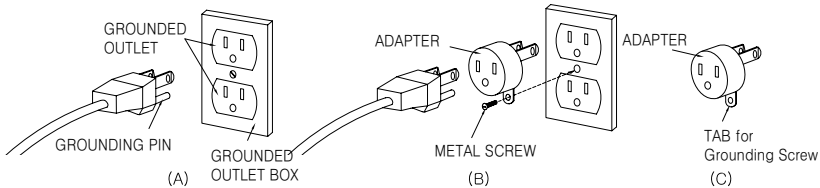

- Figure 1 -

**This appliance has to be earthed.**

**OPTIONAL GROUND INSTRUCTIONS**

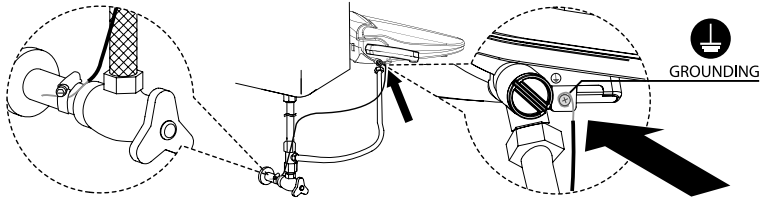

**⚠ DANGER**

IMPROPER GROUNDING CAN RESULT IN A RISK OF ELECTRIC SHOCK. Electric wiring has to be done in accordance with all local codes, or in the absence of local codes, with the National Electrical Codes.

The use of an extension cord is not recommended or advised. If it is necessary to use an extension cord, use only a three-prong extension cord (one to one), and a three slot built-in GFCI receptacle that will accept the plug on this product. The marked rating of the extension cord should be equal to or greater than the electrical rating of the unit (10amp). Consult a qualified electrician or service person if you are not sure whether the unit is properly grounded.



# 3 IDENTIFICATION

## 1 MAIN UNIT

### BB-800

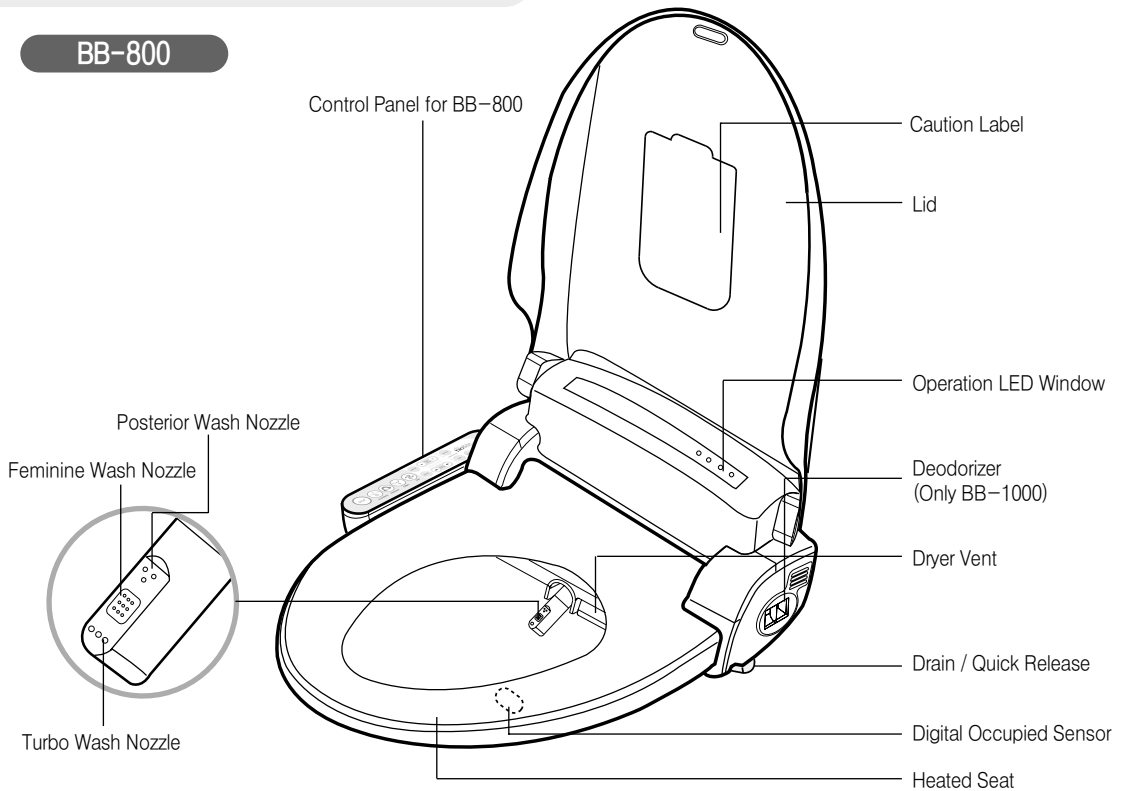

### BB-1000

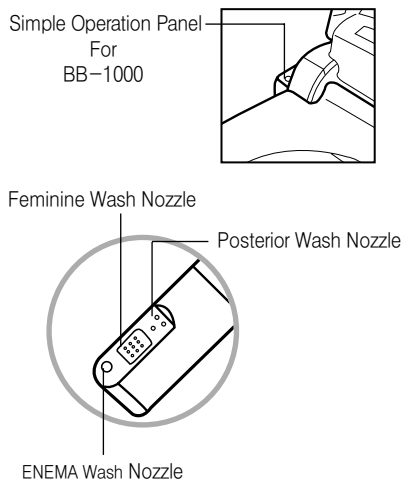

## 2 ACCESSORIES

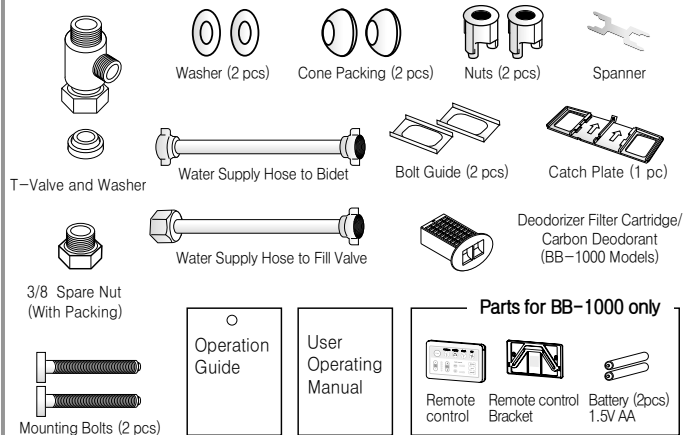

## 4 OPERATION (BASIC)

### BB-800 Control Panel

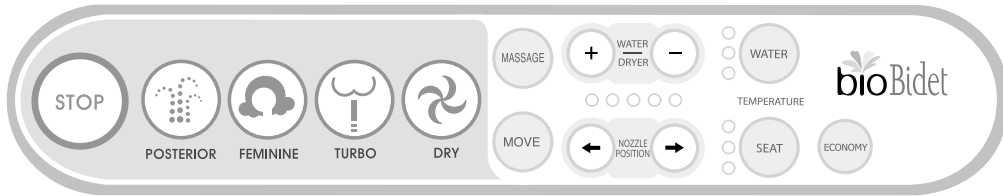

Adjust the water pressure and warm air dryer temperature.



Adjust the water and seat temperature (3 levels).



Adjust the oscillation function and nozzle position (5 levels).



Power Saving mode button.

### BB-1000 Remote Control

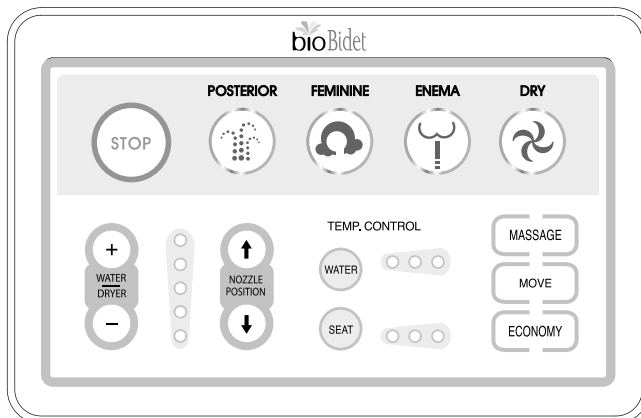

Adjust the water pressure and warm air dryer temperature.



Adjust the oscillation function and nozzle position (5 levels).



Adjust the water and seat temperature (3 levels).



Power Saving mode button.

### Simple Operation Panel



Stop



Posterior Wash

Feminine Wash

- When you sit on this product, please sit down on the central position in order to activate the sensor.
- After an extended wash, allow water to be reheated for 3 minutes.

## 5 OPERATION (DETAILS)

### 1 PREPARATION

- Check for any water leaks.
- Plug the unit into the proper power source and the LED power light will start flashing.
- Wait until the LED power light stops flashing and becomes solid red.
- The water tank will be filled after pushing a “Wash” (  or  ) button.
- When the water tank is filling the buzzer “Beeps” continuously, after the water tank is full the buzzer will end with “One Solid Beep”.

### 2 OPERATION

#### SIT DOWN ON THE SEAT

- When you sit down on the seat, the ORANGE LED lamp on the control panel will light up.
- When the digital sensor on the seat is activated, the operation LED window on the main unit will light “Occupied sensor” and simultaneously, the deodorizer fan will start to work. (BB-900 / 1000 Models)
- See page 11 for details about changing the seat or water temperature.

STOP

#### STOP

- Press this button to stop all operation.

#### CLEANSING

##### • CLEANSING 1. (Posterior Wash)

- 1- Press “Posterior Wash” (  ). Automatically, the nozzle comes out and sprays warm water to posterior.
- 2- Additional functions during your Posterior Wash experience are available. See Oscillation, pg.12 and Massage, pg. 13 for details.

##### • CLEANSING 2. (Feminine Wash)

- 1- Press “Feminine Wash” (  ). Automatically, the nozzle comes out and sprays warm water to feminine area.
- 2- Additional functions during your Feminine Wash experience are available. See Oscillation, pg.12 and Massage, pg. 13 for details.

##### • CLEANSING 3. (Turbo Wash / Enema Wash)

- 1- Press “Turbo Wash” or “Enema Wash”, the nozzle spray is more focused to produce the effect of strong wash, to help stimulate bowel movement.
- 2- Press “Water pressure – High & Low button” to adjust the water pressure.







Observe at all times

### CAUTION

DO NOT ALLOW CHILDREN TO USE THE **TURBO WASH** or **ENEMA WASH** FUNCTION! SUPERVISION IS STRONGLY RECOMMENDED FOR THE ELDERLY OR OTHER PERSONS THAT MAY HAVE LIMITATIONS IN BODY MOVEMENT, ILLNESS OR DISABILITIES!

### CLEANSING cont.



#### • CLEANSING 3. (Turbo Wash or Enema Wash)

- 1- Press "Turbo Wash" or "Enema Wash" continuously for 3 to 5 seconds. Automatically, the water nozzle comes out and sprays a warm stream of water to the posterior center of the rectum.
- 2- If necessary, adjust "Position" of water stream with the (  /  ) buttons.
- 3- Press "Water pressure High & Low button" (  /  ) to adjust the water pressure to your desired comfort.
- 4- Press the "STOP" (  ) button when you feel your abdomen is full or wait until the "Turbo Wash" or "Enema Wash" function stops, approximately 1 minutes.
- 5- You will shortly feel the urge to push the water out of your colon, push the water and feces out as thoroughly as you can.
- 6- Relax for a few minutes and be sure you feel your colon is empty and then use the "Posterior Wash" and "Air Dry" function to finish.







DRY



### WARM AIR DRYER

- 1- Press "Dry" (  ), warm, dry air is gently directed to washed area for about 3 minutes.
  - 2- You may adjust the warm air temperature by pressing High (  ) and Low (  ) buttons.
- ※This product memorizes the air temperature of prior use.

### WATER PRESSURE ADJUSTMENT

- After sitting down on the this product, the LED lamp (  ) for water pressure on the Power Control will light at third or middle level (  )
- Press high (  ) , or low (  ) to adjust the pressure of the water spray to your desired comfort level

### WARM WATER TEMPERATURE AND SEAT TEMPERATURE ADJUSTMENT

- The temperature of water and seat are adjustable to the desired level by pressing the "WATER" (  ) and "SEAT" (  ) button.

WATER TEMPERATURE

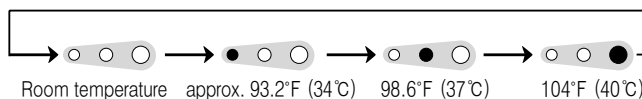

SEAT TEMPERATURE

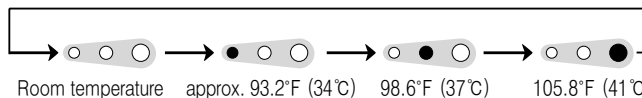

## 5 OPERATION (DETAILS)

### ● NOZZLE POSITION ADJUSTMENT

- Nozzle position is adjustable to the desired position by pressing “Front” ( ) or “Rear” ( ) button from 1 to 5 positions.  
After using this product, the nozzle will return to position 3.

### ● DEODORIZER

(BB-1000 Model Only)

- The deodorizer fan is activated when this product is occupied.  
When finished, the fan will stop after 1 minute.
- Air current for the deodorizer has 4 adjustable levels. While pressing the “STOP” ( ) button, press the “WATER” ( ) button to the desired air current level. See diagram:

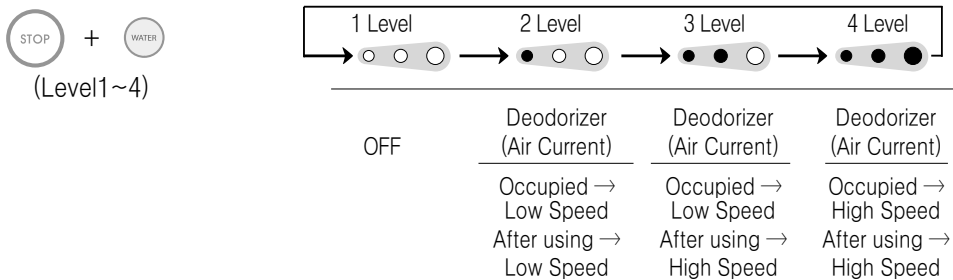

### ● OSCILLATION ( Nozzle Movement Function)

- When using Posterior or Feminine Washing functions, pressing the “MOVE” ( , ) button will provide a short-motion, front to back oscillating spray for a much wider cleansing experience. Note: This function will not work during the “Turbo Wash” or “Enama Wash” function.
- You may change the position of the Oscillating spray by pressing the “MOVE” ( , ) button again and “Front” ( ) or “Rear” ( ) buttons simultaneously.
- Push the “MOVE” ( , ) button again and the oscillation motion will stop automatically.

#### Auto-Setting of Oscillation Feature

- You can set this function to automatically oscillate whenever the seat is occupied and the Posterior or Feminine washes are in operation.

**Step 1:** Do not sit on the this product.

**Step 2:** Press the “MOVE” ( , ) button for 3 seconds or until you hear a single Chime.

**Step 3:** Sit on the this product and proceed with Posterior or Feminine Wash.







**Note:** In the automatic setting, you may still adjust the position of the Oscillating spray by pressing the “Front” ( ) or “Rear” ( ) buttons.

#### Canceling the Automatic Oscillation function

**Step 1:** Do not sit on the this product.

**Step 2:** Press the “MOVE” ( , ) button for 3 seconds or until you hear a double Chime.

## ● MASSAGE (Rhythm Wash)

- When using the Posterior Wash or Feminine Wash functions, pressing the “MASSAGE” (  ,  ) button will provide a pulsation spray.
- You may change the pressure of the spray by pressing the “High” (  ) button or “Low” (  ) buttons.
- Push the “MASSAGE” (  ,  ) button again and the pulsating action will stop automatically.



### Auto-Setting of Massage Feature

- You can set this function to automatically pulsate whenever the seat is occupied and the Posterior or Feminine washes are in operation.

**Step 1:** Do not sit on the this product.

**Step 2:** Press the “MASSAGE” (  ,  ) button for 3 seconds or until you hear a single Chime.

**Step 3:** Sit on the this product and proceed with Posterior or Feminine Wash.

**Note:** In the automatic setting, you may still adjust the pressure of the pulsating spray by pressing the “high” (  ) or “low” (  ) functions.

### Canceling the Automatic Oscillation function

**Step 1:** Do not sit on the this product.

**Step 2:** Press the “MASSAGE” (  ,  ) button for 3 seconds or until you hear a double Chime.

## ● ECONOMY (Energy Save Mode)

- The ENERGY SAVER is not on when the LED light is off.
- Press button once to choose “ECONOMY 1”
- Press button again to choose “ECONOMY 2”
- Press button third time to turn “ECONOMY” off







\*The ECONOMY 1 : the water temperature will be kept at 90°F (32°C)

\*The ECONOMY 2 (SMART MODE) : this will lower the water temperature to 90°F (32°C) when it is not being used, and raise the water temperature back to normal level during the time of use. It takes about 5 days for the unit to “learn”, and “remember”, the usage pattern of the user(s)

## ● NOZZLE CLEANING (Automatically)

- This product has an automatic nozzle self-cleaning function that cleans the nozzle before and after each use.

## ● NOZZLE CLEANING (Manual)

- Nozzle can be cleaned manually by pressing “Posterior Wash” (  /  ) button for 3 seconds without being occupied on the seat and nozzle will come out without spraying water. After cleaning the nozzle, Press “Stop” (  ,  ) button to return nozzle to stand-by mode. (  ,  : in Simple Operation panel –Remote Model)

## ● CHIME SOUND ON/OFF SET

- While sitting on the this product, press “MOVE” (  ,  ) button for 3 seconds and you can hear the chime sound change to ON or OFF. (Remote model doesn't have off function, BB-1000)

## 6 INSTALLATION



### CAUTION BEFORE INSTALLATION

- Do not plug in before installation.
- If you need an electric power system or extension, please consult a qualified electrician.

### STEPS

#### 1 Turn Off Water.

- Shut off the water supply shut off valve. Drain the toilet tank completely. Then remove the existing fill valve water supply hose.

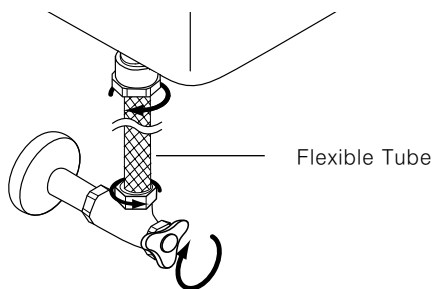

#### 2 Removing the existing seat and lid.

- Remove mounting bolts to release existing toilet seat from toilet.



#### 3 Connect T-Valve.

- Remove existing supply tube from fresh tank
- Connect supplied 1/2" T-Valve Adaptor. Use 3/8" conversion nut if existing shut off valve is 3/8".

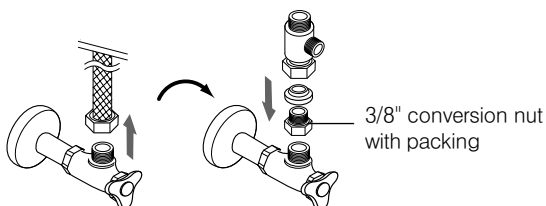

#### 4 Water Supply to Tank Assembly.

- Connect supplied fill valve water supply hose as illustrated.

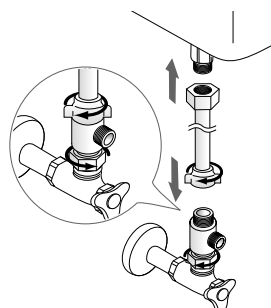

※Check for any water leaks.

## 5 Installation Catch Plate.

Place the plate and guides over each mounting hole. Insert the mounting bolts through the plate and mounting holes.

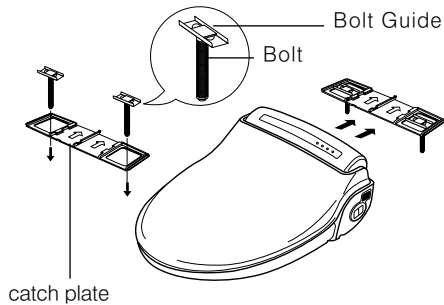

## 6 Bolt and Nut Assembly.

Slide cone packing and washers onto the bolts then fasten to securely mount bidet seat to toilet.

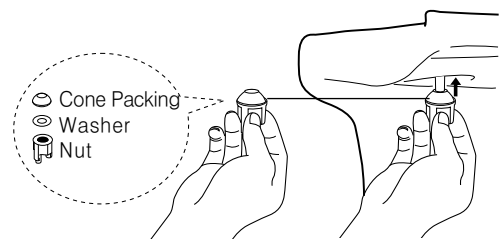

## 7 Assembly.

1. Slide this product onto the catch plate centering the unit with the guide arrows on the Base.
2. You will hear a click once this product is securely mounted to the catch plate.
3. This product will feel a little loose on the toilet bowl. Adjust the fit from front to back and side to side for balance.
4. Tighten the nuts on both bolts securely.

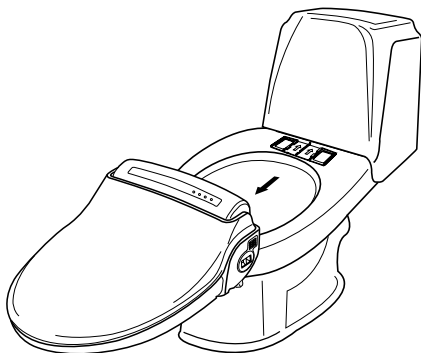

## 8 Water Supply Tube Assembly.

1. Connect the flexible tube from side of T-Valve to the this product.
2. Open water valve.
3. Check for leaks.
4. If there are no leaks and the surrounding area is clean and dry, connect the power cord to a ground protected power outlet.

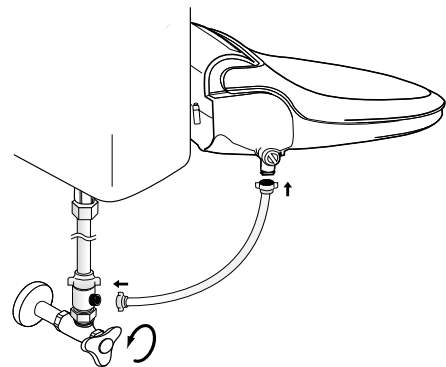

※Check for any water leaks.



## 6 INSTALLATION

### 9 Deodorizer Installation.

Insert the deodorant cartridge into the unit.  
(BB- 1000 Only)

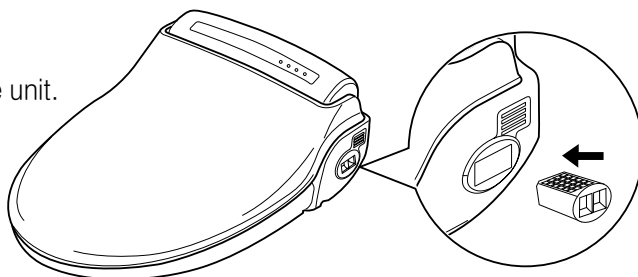

How to change the deodorant catalyst

1

- Deodorant assembly diagram.
- Follow the below photos to change the deodorant.

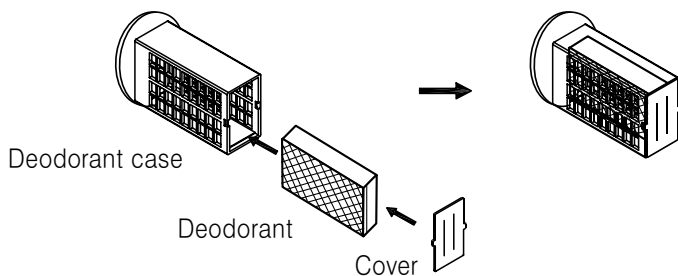

2

Insert the new deodorant case into the unit.

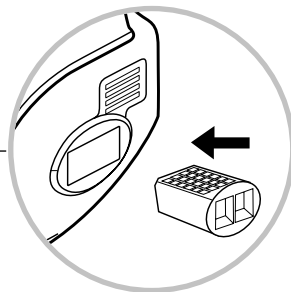

### 10 Wireless remote mounting guide. (BB-1000)



1. Remove adhesive from back of bracket and place bracket where desired.

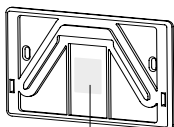

2. Place remote into remote bracket.

Adhesive Tape

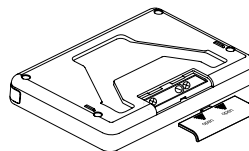

Insert supplied batteries and close battery cover

## 7 SEPARATION OF UNIT FROM THE TOILET BOWL





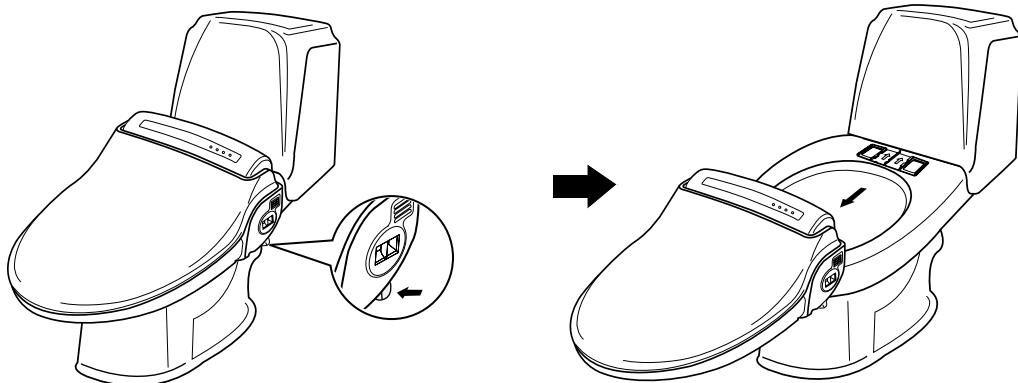
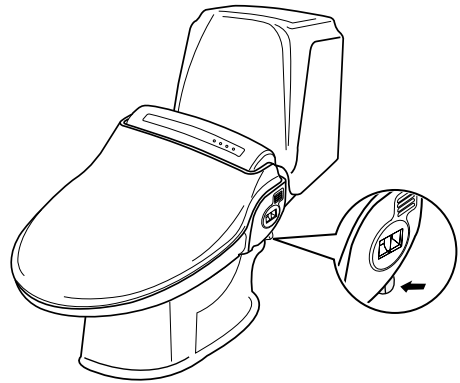

- 1 Disconnect the power plug.
- 2 Close water supply shut-off valve.
- 3 Drain water from bidet seat using drainage as illustrated.
- 4 Remove bidet seat from toilet as illustrated.  
-Drainage is also release button from catch plate.

 Do not turn unit upside down.



## 8 MAINTENANCE

### ● CLEANING THE NOZZLE

- When the “Posterior Wash (  /  )” button is pressed for 3 seconds without occupying the seat, the nozzle can be cleaned with a soft toothbrush.  
(  : in Simple Operation panel –Remote Model)
- After cleaning the nozzle, push the “Stop (  ,  )” button once again, and the nozzle retracts itself.  
(  : in Simple Operation panel –Remote Model)

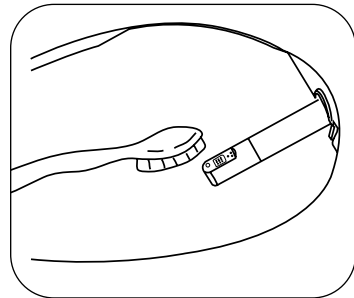

### ● CLEANING THE BODY OF UNIT

- When you clean this product, do not use thinner, benzene or toilet bowl cleaner. It may cause damage to the surface of unit.
- Use a wet cloth when you clean this product.
- Do not spray water directly on to this product.
- When you clean this product, disconnect the power plug.

### ● CLEANING THE STRAINER

**This product will not operate properly if the strainer is clogged. Please clean the strainer regularly.**

- 1) Close the water shut off valve.
- 2) Flush the toilet to empty the water reservoir.
- 3) Unscrew the water filter nut.
- 4) Clean the strainer with a small brush or water.
- 5) Re-screw the water filter nut.
- 6) Open the water shut off valve.

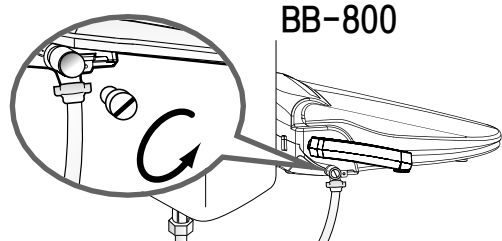
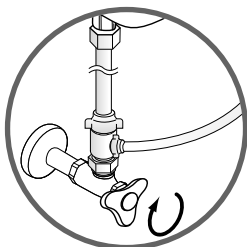
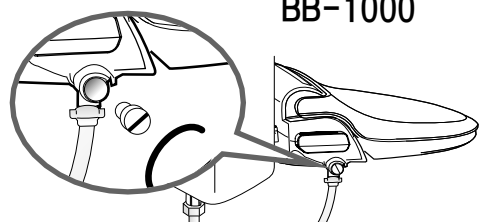

**BB-800**

**BB-1000**

## 9 WATER DRAINING

### ● DRAINING THE WARM WATER TANK IN THE UNIT

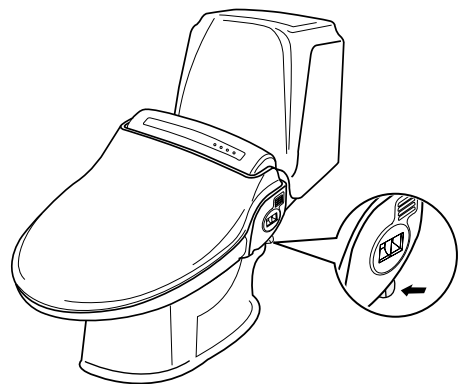
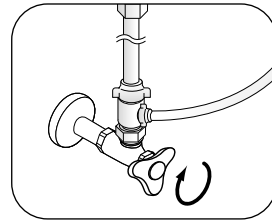
If you do not intend to use this product for 14 days or longer, drain the water from this product warm water tank.

- 1) Disconnect the power plug.
- 2) Close the water shut off valve.
- 3) Press the drain lever until the water is completely drained from water tank.
- 4) To re-supply water after draining, open the water shut off valve.



Do not drink the drained water.  
Do not insert finger into the drain hole.  
Before draining, unplug the power cord and wait 30 minutes until the unit has cooled down.

## MAINTENANCE FOR WINTER SEASON

- 1 Check the power cord if it is plugged in or not.
- 2 Keep the water temperature on Middle or High Level to prevent water from freezing.
- 3 If you do not intend to use the unit for 14 days or longer, disconnect the power plug and drain the water.

# 10 TROUBLE SHOOTING

Trouble	Cause	Remedy
<p>The washing water does not spray</p>	<ol style="list-style-type: none"> <li>1.The water tank is not filled.</li> <li>2.The shut off valve is closed.</li> <li>3. Freezing inside the main unit or the water supply pipe.</li> </ol>	<ol style="list-style-type: none"> <li>1. Wait about one minute.</li> <li>2.Press the desired washing button once again.</li> <li>3.Turn on the shut off valve to open.</li> <li>4.Heat the room (for about two hours). Operating the unit while parts are frozen will cause a malfunction.</li> </ol>
<p>The unit is not operating</p>	<ol style="list-style-type: none"> <li>1.Disconnected the power cord.</li> <li>2.The seat is not occupied.</li> <li>3. The battery of remote controller is exhausted. (Only BB-1000 model)</li> </ol>	<ol style="list-style-type: none"> <li>1.Connect the power cord.</li> <li>2. Check the power supply system in your house.</li> <li>3.Occupy the seat (The unit has an occupied sensor).</li> <li>4.Replace the battery.</li> </ol>
<p>Water is leaking</p>	<ol style="list-style-type: none"> <li>1.Check the water supply system</li> </ol>	<ol style="list-style-type: none"> <li>1. If water is leaking from the main unit, call the service center or the place you purchased unit.</li> </ol>
<p>The washing water pressure is weak</p>	<ol style="list-style-type: none"> <li>1.The water pressure level is set to LOW .</li> <li>2.The strainer is clogged.</li> </ol>	<ol style="list-style-type: none"> <li>1.Set the water pressure to HIGH .</li> <li>2.Clean the strainer.</li> </ol>
<p>The washing water is not warm</p>	<ol style="list-style-type: none"> <li>1.The water temperature is set to LOW .</li> <li>2.Continuous operation has depleted the supply of warm water.</li> </ol>	<ol style="list-style-type: none"> <li>1.Set the water temperature to HIGH</li> <li>2. Wait about three minutes.</li> </ol>
<p>The seat and dryer is not warm</p>	<ol style="list-style-type: none"> <li>1.The seat &amp; dryer temperature is set to LOW</li> </ol>	<ol style="list-style-type: none"> <li>1. Set the seat &amp; dryer temperature to HIGH .</li> </ol>

# 11 SPECIFICATIONS

Specification		BB-800	BB-1000	
Power Rating		Australia or Europe: 220 – 240V~, 50/60Hz , 600 – 700W America or Canada: 120Vac, 60Hz, 660W		
Water inlet type	Type	Direct Inlet flow type		
	Water inlet pressure	0.4 ~ 7.5 kgf/cm <sup>2</sup> ( 5.69 psi ~ 106.7psi )		
Power cord		(1.2m (4 feet): AMERICA) / (1.8m:Australia or Europe)		
Wash Device	Posterior Wash	Max. 1.2 ℓ /min ( Max. 0.32 GPM )		
	Feminine Wash	Max. 1.2 ℓ /min ( Max. 0.32 GPM )		
	Water Pressure Adjustable	5 Levels		
	Warm Water Temperature	Room Temp – 40°C ( Room Temp. 104°F )		
	Heater	600 W		
	Safety Devices	Thermal fuse, Thermal switch, Float switch		
Heated Seat	Temperature	Room Temp ~ 41°C ( Room Temp. ~ 105.8°F )		
	Heater	55 W		
	Safety Device	Thermal fuse		
Warm Air Dryer Device	Adjustable Dry Temperature (Room Temp~45°C)			
	Heater (250W)	○	○	
	Safety Device (Thermal fuse, bimetal)			
Turbo& Enema Function		○	○	
Deodorizer		-	○	
Remote control		-	○	
Inlet water temperature		3°C~ 35°C ( 37.4°F ~ 95°F )		
Ambient Temperature		3°C~ 40°C ( 37.4°F ~ 104°F )		
Dimension	Elongated(Control)	Round (Control)	Elongated (Remote)	Round (Remote)
	W : 495mm (19.4 inch) L : 525mm (20.6 inch) H : 185mm (7.28 inch)	W : 495mm (19.4 inch) L : 493mm (19.4 inch) H : 185mm (7.28 inch)	W : 475mm (18.7 inch) L : 525mm (20.6 inch) H : 185mm (7.28 inch)	W : 475mm (18.7 inch) L : 493mm (19.4 inch) H : 185mm (7.28 inch)
Weight (kg)		5.3kg	5.4kg	5.2kg

## 12 WARRANTY

### Three Year Warranty

1. The BBC Innovation corp. warrants the Bio Bidet to be free from manufacturing defects under normal and intended use. This warranty is extended only to the original retail buyer and residential location for a 3 years prorated base as explained above from date of original purchase.
2. The BBC Innovation corp. obligations are limited only to the repair or replacement of the Bio Bidet that we find to be defective provided that the Bio Bidet was properly installed and used according to the instruction manual included.
3. The BBC Innovation corp. will not charge for Labor or parts in connection with the repair or replacement of the Bio Bidet.
4. The BBC Innovation corp. will not be responsible for any consumer costs related to the removal, return to The BBC Innovation corp. and / or reinstallation of the Bio Bidet.
5. The BBC Innovation corp. will not be responsible for any consumer loss related to incidental, consequential damages or expenses incurred by the purchaser.
6. Not covered by this warranty are:
  - Loss or damage from fire, flood, freeze, electrical storm or any other natural calamity or act of God.
  - Defects or malfunctions resulting from failure to properly install, operate and/or maintain the Bio Bidet to residential water toilets in accordance with the enclosed installation manual.
  - Loss or damage from misuse, abuse or negligence.
  - Damage resulting from unauthorized alterations, attachments and/or repairs.
  - Loss or damage from installing the unit in a harsh or hazardous environment and/or an environment including animals, mice or insects.
  - Damage caused from excess moisture or from sediments or foreign matter contained in the water system.
  - Damage from not being installed in accordance with all local codes, ordinances and good trade practices.
  - Color fading due to an installation in the wrong environment.
  - Loss or damage from consumable chemicals such as chlorinates (found in public water supplies) or from cleaning agents warned about in the installation manual.
  - Damage to the toilet bowl that the Bio Bidet is installed to.
7. The BBC Innovation corp. will only warrant products with returned registration cards or from on-line registration with proof of purchase within 30 days of the original purchase date.
8. This warranty is also void if the "CAUTION" label is removed from the inside of the Bio Bidet cover.
9. This limited warranty gives you specific legal rights and you may also have other rights that may vary from state to state.

This is the BBC Innovation corp's exclusive limited warranty.

## 13 INFORMATION TO THE USER (For America)

This equipment has been tested and found to comply with the limits for a Class B digital device, pursuant to part 15 of the FCC Rules. These limits are designed to provide reasonable protection against harmful interference in a residential installation. This equipment generates, uses and can radiate radio frequency energy and, if not installed and used in accordance with the instructions, may cause harmful interference to radio communications. However, there is no guarantee that interference will not occur in a particular installation. If this equipment does cause harmful interference to radio or television reception, which can be determined by turning the equipment off and on, the user is encouraged to try to correct the interference by one more of the following measures:

- Reorient or relocate the receiving antenna.
- Increase the separation between the equipment and receiver.
- Connect the equipment into an outlet on a circuit different from that to which the receiver is connected.
- Consult the dealer or an experienced radio/TV technician for help.

### ● WARNING

Changes or modifications not expressly approved by the manufacturer could void the user's authority to operate the equipment.

**Note :** The manufacturer is not responsible for any Radio or TV interference caused by unauthorized modifications to this equipment. Such modifications could void the user's authority to operate the equipment.

### For Service & Technical Support, call or write to:

BBC Innovation Corporation  
205 Berg St  
Algonquin, IL 30102  
U.S.A

Tel: 847.854.7292  
Fax: 847.854.1296  
Support@biobidet.com