



Professional Spacesaver

Assembly Instructions

For models X-3-XB, X-4-XB,
X1-3-XB, X1-4-XB, XII-3-XB, XII-4-XB

Tools Required: Phillips screwdriver, drill with 1/8" bit.

Parts Included:

A 1pc Leg Frame

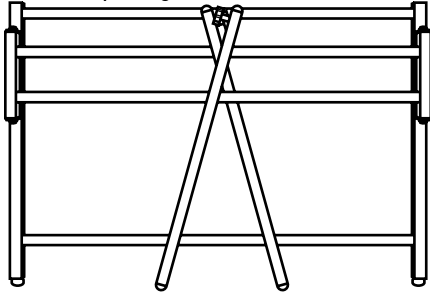

B 1pc Tabletop

(Shipped in separate box)

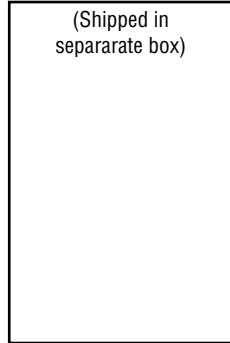

C 2pcs Rear Extension Tubes

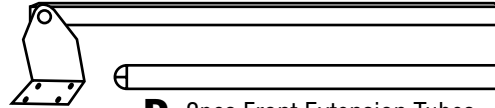

D 2pcs Front Extension Tubes

F 2pcs Height Adjustment Knobs

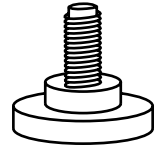
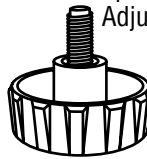

E 2pcs Floor Glides

H 12pcs 1/2" Wood Screws

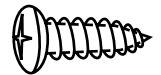

G 2pcs Leg Support Braces



To Assemble:

- 1 Unpack all parts and inspect to confirm that all are present.
- 2 Unfold base (A).
- 3 Insert rear extension tubes (C) completely into frame (A) and loosely hand-tighten knobs (F).
- 4 Insert front extension tubes (D) into frame (A).
- 5 Place table top (B) with preferred side facing down on carpeted or protected floor. Place supplied cardboard template on board surface with edge of template at front edge of board. Left and right edges of template should be an equal distance from each side of the table top. Using a 1/8" drill bit, gently drill 1/4" deep holes where indicated on the template (red squares for 24" x 36" top or black holes for 31" x 42"; template marked XB-II is for 36" x 48" top). Remove template.

TIP Wrap masking tape 1/4" from drill bit end to determine drilling depth. Take care to drill only 1/4" deep to avoid drilling through and damaging table top surface.

- 6 Using the Phillips screwdriver, screw the leg support braces (G) onto the tabletop (B) as shown in *Figure 1*.
- 7 Carefully turn table frame upside down and place on top of tabletop. Align holes in front leg extensions (D) with holes in table top as shown in *Figure 1*. Fasten all 1/2" screws (H) and tighten securely. Use care not to overtighten and strip.
- 8 Carefully return table assembly to the upright position. Adjust table top to desired height using height adjustment knobs (F).

You're finished and your table is ready to use as shown in *Figure 2*.

Folding Table:

Drop all extension tubes down to their lowest positions. Lift top up until the front extension tubes (D) disengage with the support braces (G), then move the left leg assembly in until it is flush against the rear frame assembly. Next move the right leg assembly in flush against the left leg assembly. Gently lower the table top down flush against the right leg assembly. The table is now ready for storage.

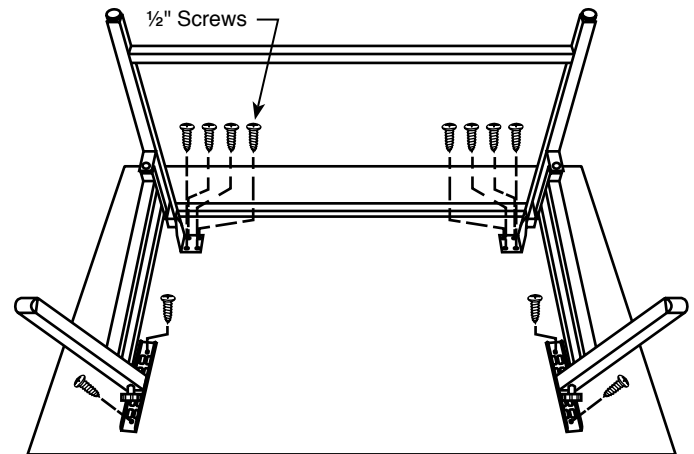

Figure 1

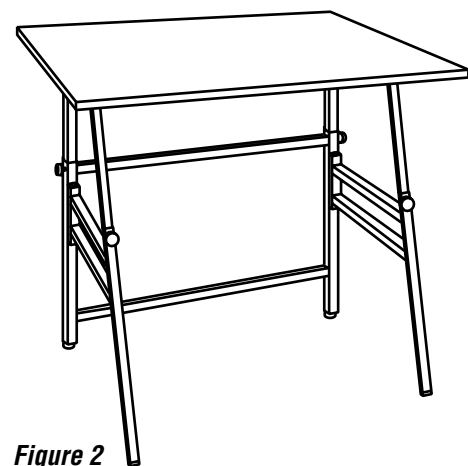

Figure 2

Professional Spacesaver Models		
X-3-XB	XI-3-XB	XII-3-XB
X-4-XB	XI-4-XB	XII-4-XB