

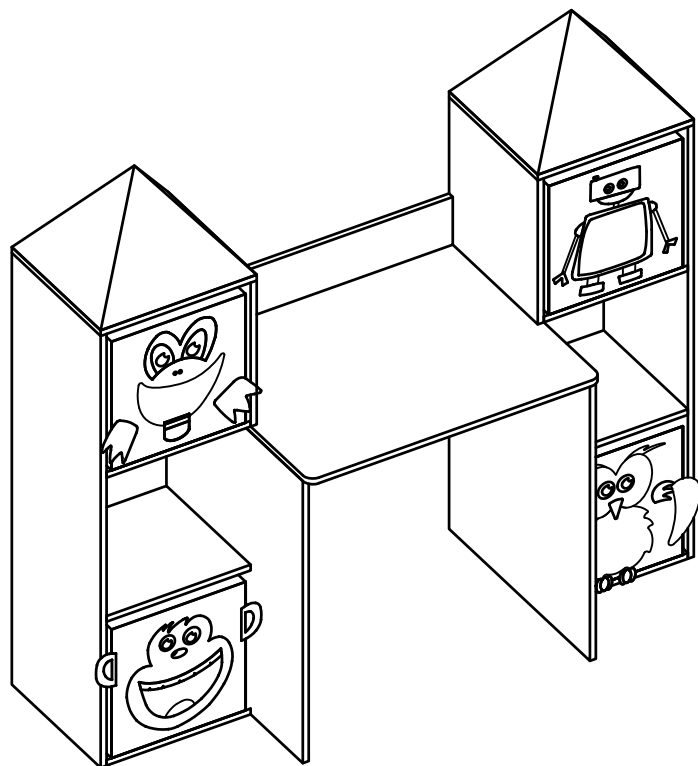

7880096



THIS INSTRUCTION BOOKLET CONTAINS **IMPORTANT** SAFETY INFORMATION. PLEASE READ AND KEEP FOR FUTURE REFERENCE.
ESTE FOLLETO DE INSTRUCCION CONTIENE INFORMACION **IMPORTANTE** DE SEGURIDAD. POR FAVOR LEA Y GUARDE PARA REFERENCIA FUTURA.



DO NOT RETURN PRODUCT TO THE STORE
Individual stores do not stock parts.

NO DEVUELVA ESTE PRODUCTO A LA TIENDA
Las tiendas no almacenan partes.

Lot Number / Número de Lote: _____

Date Of Purchase / Fecha de Compra: ___/___/___

If a part is missing or damaged, call our toll-free customer service line. We will gladly ship your replacement parts FREE of charge.

Si faltan partes o piezas, o éstas están dañadas, llame gratis al teléfono de servicio al cliente. Con gusto le enviaremos las partes sin cargo alguno.

Need Parts or Assistance?
Nesacitas partes o asistencia?

1-800-489-3351

or access our website
o visite nuestra página de internet
@www.altrafurniture.com

For prompt, reliable service please have your assembly manual ready.
Para obtener servicio rapido y confiable, por favor tenga esta manual a la mano.

Recommended # of people needed for assembly: 1
El número recomendado de personas necesarias para el montaje: 1

Thank you for purchasing from Altra Furniture.
Visit www.altrafurniture.com to view the limited warranty valid in the U.S. and Canada.

ALTRA FURNITURE CUSTOMER SERVICE

Gracias por haber comprado de Altra Furniture.
Visitar www.altrafurniture.com para mirar la garantía limitada válida solamente en U.S.A y Canada.

SERVICIO A LA CLIENTE DE ALTRA FURNITURE

Before starting - Antes de empezar.

- Read each step carefully before starting. It is very important that each step of instruction is performed in the correct order. If these steps are not followed in sequence, assembly difficulties will occur.

Leer con cuidado cada paso antes de empezar. Es muy importante de ejecutar cada paso en el orden correcto. Si los pasos no están ejecutados en secuencia, ocurrirá dificultades en el montaje.

- Make sure all parts are included. Most board parts are labeled or stamped on the raw edge. Asegurar que todas las piezas son Incluidas. La mayoría de las tablas tienen las etiquetas o los sellos en el lado sin acabado.

- Work in spacious area, preferably on a carpet, near the place the unit will be used. Trabajar en una área espaciosa, preferible sobre alfombra, cercas del lugar donde se va a usar el mueble.

- Have the following tools close at hand. Tener las herramientas siguientes cerca de la mano.

- Do not use power tools to assemble your furniture. Power tools may strip or damage the parts. No use herramienta eléctrica para montar su unidad. Las herramientas eléctricas pueden dañar las piezas.

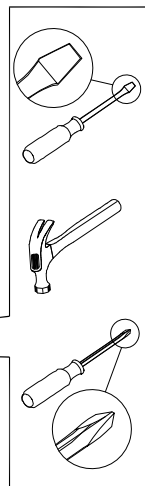

Call us at:
Llamar a:

1-800-489-3351
(in U.S.A. only)
(Solo en U.S.A)



Fax:
Fax:

1-636-745-1005

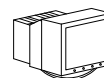

Visit our Website:

Visitar nuestro website: www.altrafurniture.com



Write to:
Escribir a:

ALTRA FURNITURE
410 East 1st Street South Wright City, MO 63390 USA
Attn: Service Dept.

9:00am - 5:00pm

Monday - Friday
~~7:00am - 8:00pm~~
Central Time

~~Saturday~~
~~9:00am - 5:00pm~~
~~Central Time~~

Lunes - Viernes
~~7:00am - 8:00pm~~
Tiempo Central

~~Saturday~~
~~9:00am - 5:00pm~~
~~Tiempo Central~~

HELPFUL HINTS

- Visit our website for assembly video clips.
- Identify, sort and count the parts before attempting assembly.
- Call our toll free number if you need assistance identifying parts.
- Compression dowels are tapped in with a hammer.
- Slides have lips only on the right side.
- Cam locks that are properly fastened on a horizontal board will face toward the center of the unit, on a vertical board the point on the lock will face the bottom.
- Back panels provide stability and support. Use all the nails provided.
- When tapping nails into a board, be sure there are equal margins on all sides to square the unit.
- Units without the back panel installed may collapse.
- Clean the product with your favorite furniture polish and a soft cloth. DO NOT USE harsh chemicals or abrasive cleaners.
- Move your new furniture carefully, with two people lift and carry the unit to its new location.
- Never push, drag or scoot your furniture (especially on carpet).
- Your furniture can be disassembled and reassembled to move.
- Additional parts are available for a nominal fee.

NOTES UTILES

- Visitar nuestro website para mirar los videos cortos del montaje.
- Identificar, clasificar y contar las piezas antes de intentar el montaje.
- Llamar gratis a nuestro número de servicio si necesita ayuda con identificar las piezas.
- Las clavijas de compresión se taladran con un martillo.
- Las correderas sólo tienen las protrusiones en el lado derecho.
- Las cerraduras de leva que se atan propiamente en una tabla horizontal se puntan al centro de la unidad, y las en una tabla vertical se puntan al fondo.
- Los paneles traseros se mantienen la estabilidad. Usar todos los tornillos proporcionados.
- A taladrar los tornillos en una tabla, asegurarse que hay márgenes iguales en todos los lados para cuadrar la unidad.
- Las unidades sin panel trasero pueden derrumbarse.
- Limpiar la unidad con su pulimento favorito de mueble y una tela suave. NO UTILIZAR productos con químicos duros o abrasivos.
- Mover su mueble nuevo cuidadosamente, con dos personas levantar la unidad a su nuevo lugar.
- Nunca empujar o arrastrar su mueble (especialmente en alfombra).
- Poderse desmontar y volver a montar su mueble de para mover.
- Piezas adicionales están disponibles para una cuota nominal.

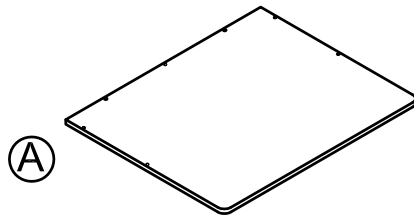

Desktop
Tablero del escritorio
T7880096010

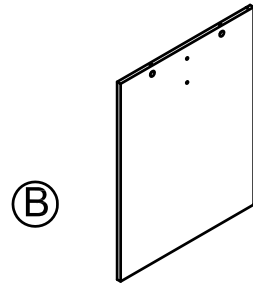

Under Left Side Panel
Debajo de panel del lado izquierdo
T7880096020

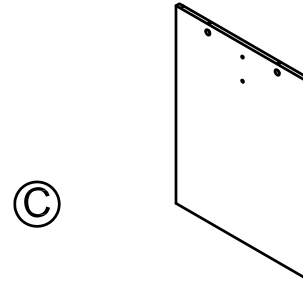

Under Right Side Panel
Debajo de panel del derecho
T7880096030

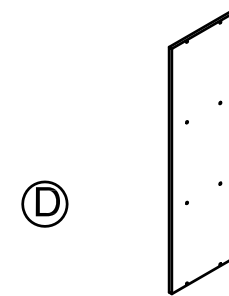

Side Panel (2)
Panel lateral (2)
T7880096040

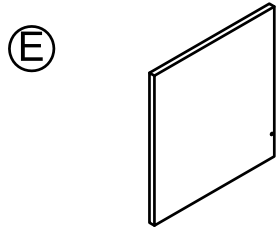

Upper Left Side Panel
Panel superior del lado izquierdo
T7880096050

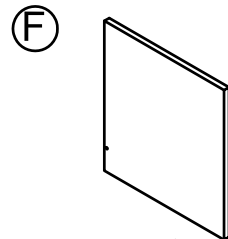

Upper Right Side Panel
Panel superior del derecho
T7880096060

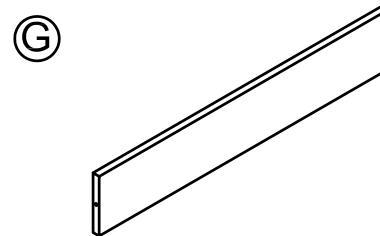

Upper Rail
Carril superior
T7880096070

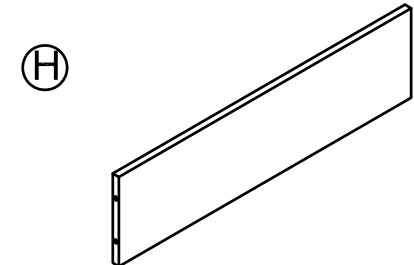

Under Rail
Debajo del carril
T7880096080

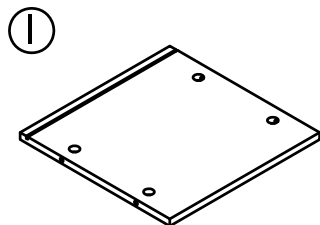

Top Panel (2)
Panel superior (2)
T7880096090

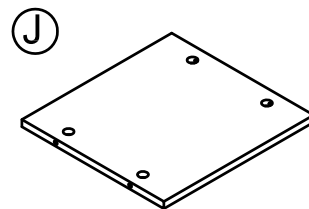

Shelf Panel (4)
Panel del estante (4)
TBQ0039

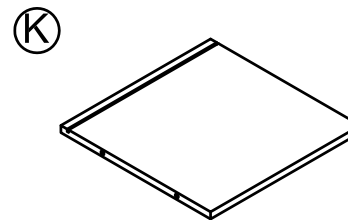

Bottom Panel (2)
Panel inferior (2)
T7880096100

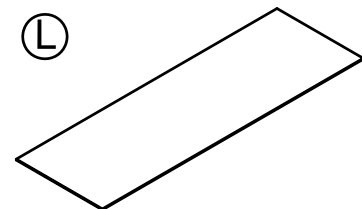

Back Panel (2)
Panel trasero (2)
T7880096110

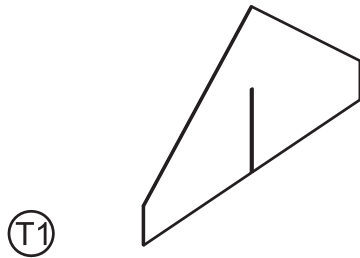

T1
Paperboard A (2)
Cartulina A (2)
TBQ0023

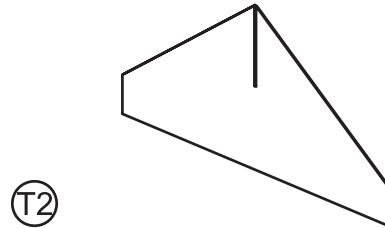

T2
Paperboard B (2)
Cartulina B (2)
TBQ0024

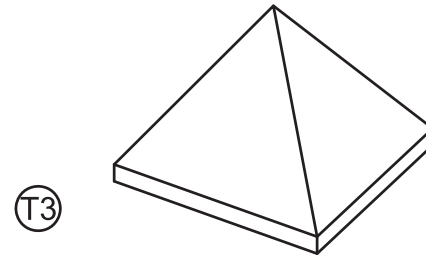

T3
Red Top (2)
Tapa roja (2)
TBQ0025

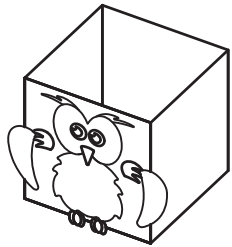

Owl Bin
Compartimiento del buho
TBQ0026

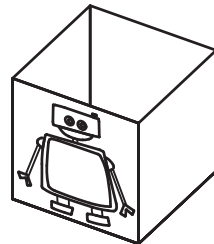

Robot Bin
Compartimiento de Robustezza
TBQ0027

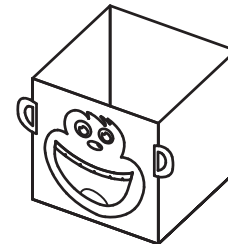

Monkey Bin
Compartimiento del mono
TBQ0028

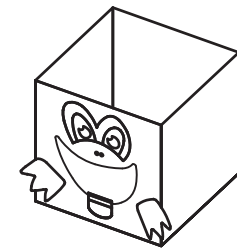

Frog Bin
Compartimiento de la rana
TBQ0029

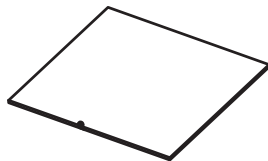

White Bottom Panel
Panel inferior blanco
TBQ0033

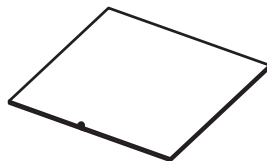

Green Bottom Panel
Panel inferior verde
TBQ0034

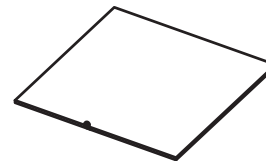

Yellow Bottom Panel
Panel inferior amarillo
TBQ0035

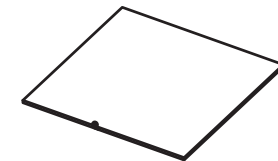

Brown Bottom Panel
Panel inferior marrón
TBQ0036

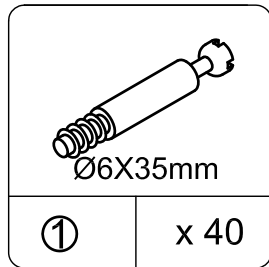

Cam bolt
Tornillo de rosca
TBQ2002

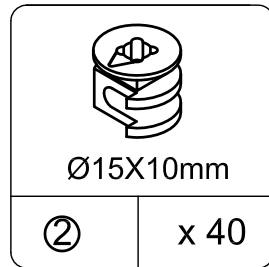

Cam lock
Tornillo de rosca
TBQ2003

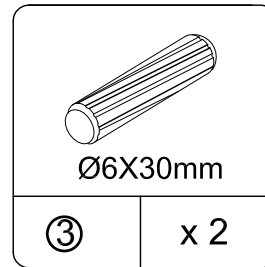

Wood dowel
Clavija de madera
TBQ4002

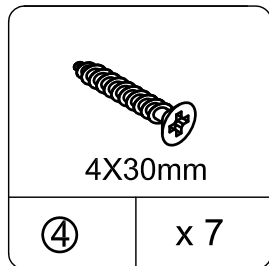

Screw
Tomillo
TBQ1004

This illustration shows how the CAM fastening system works.
Esta ilustración muestra el sistema de fijación de leva y como funciona.

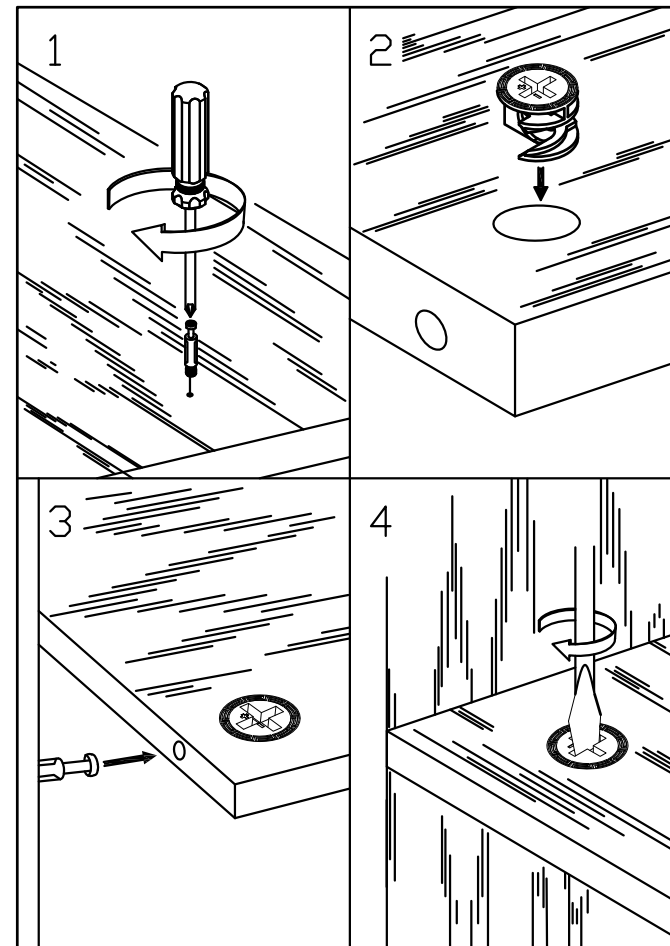

To view a video on how the CAM fastening system works, download a free QR-reader on your smartphone, then scan the code.

Para ver un video de como funciona el sistema de sujeción CAM, descargue una aplicación gratis que podrá ver en su teléfono móvil, entonces escanee el código.

1

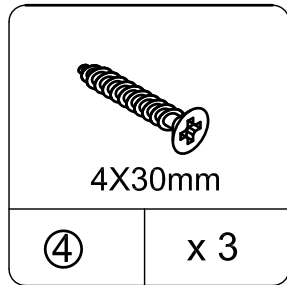
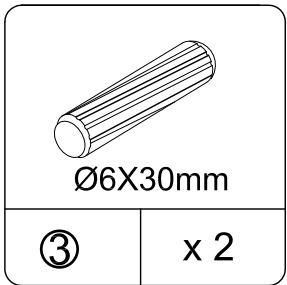
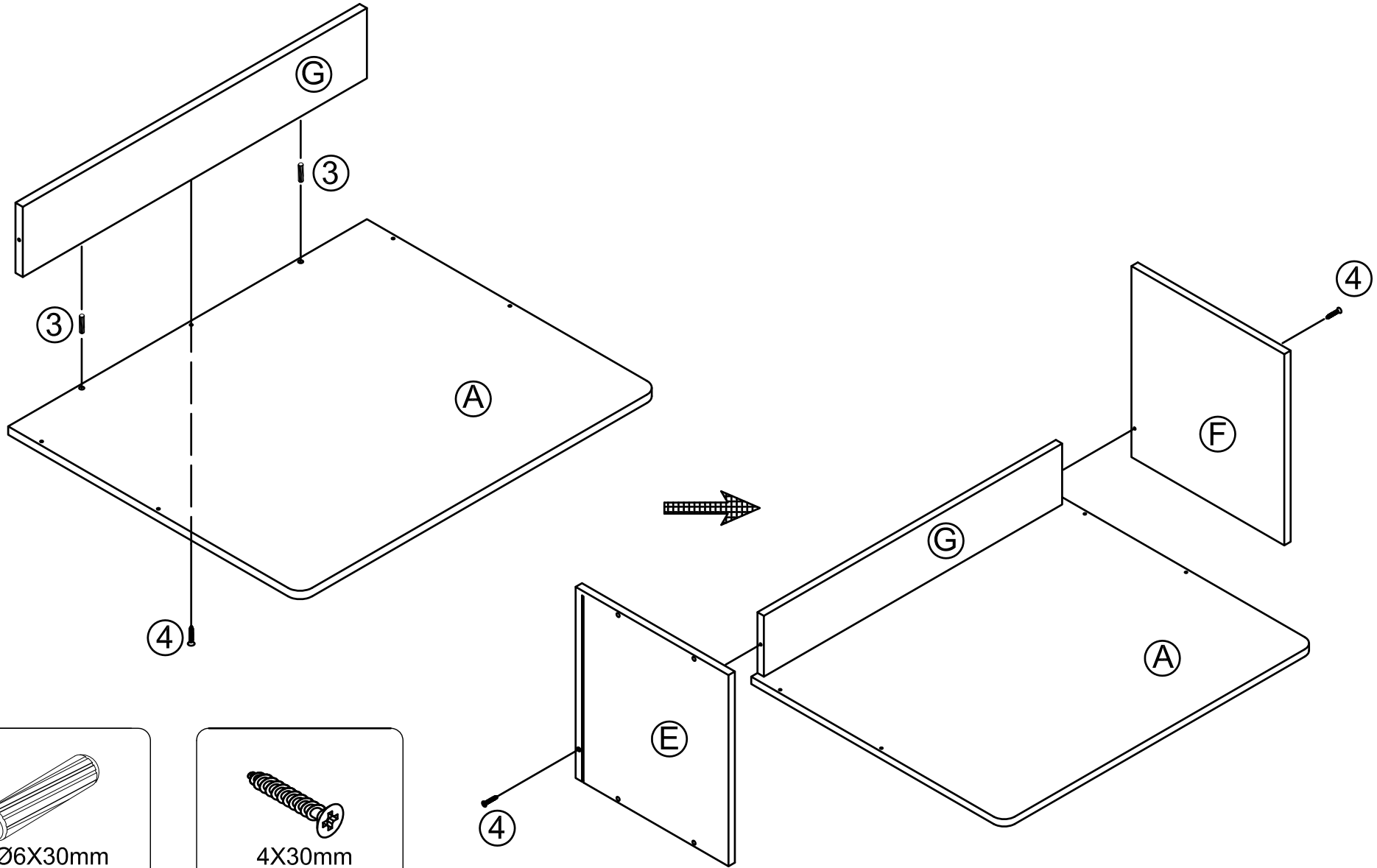

2

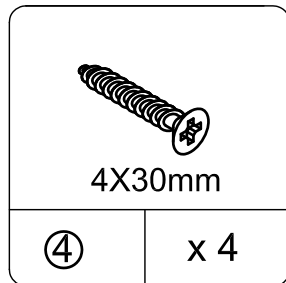
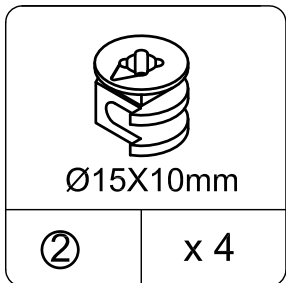
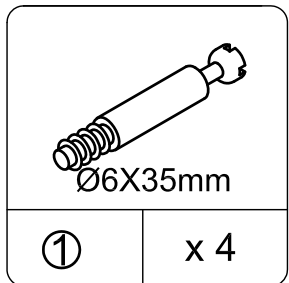
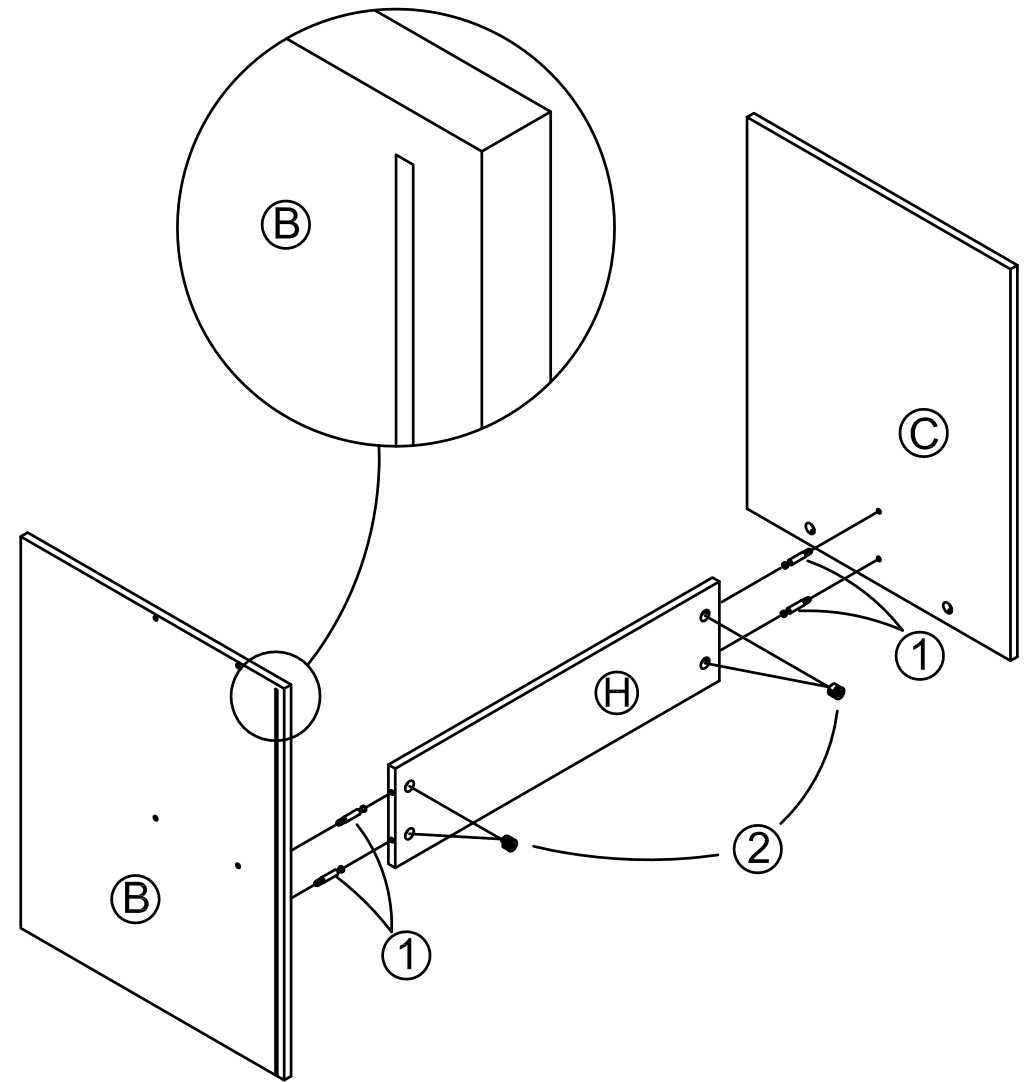
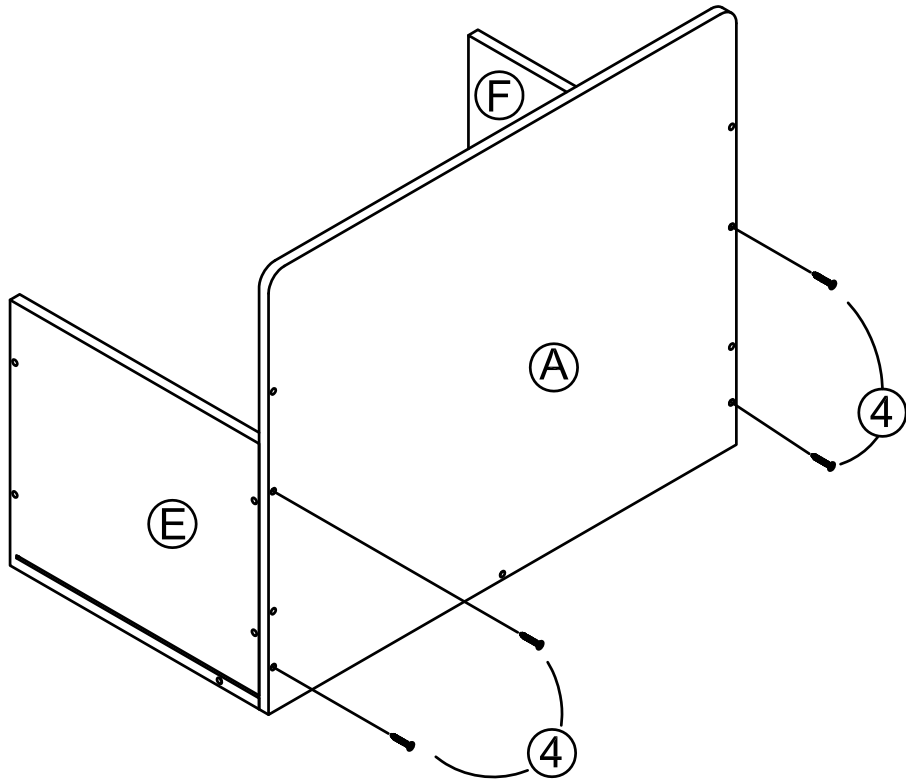

3

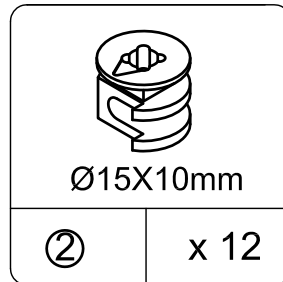
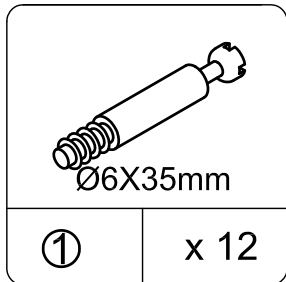
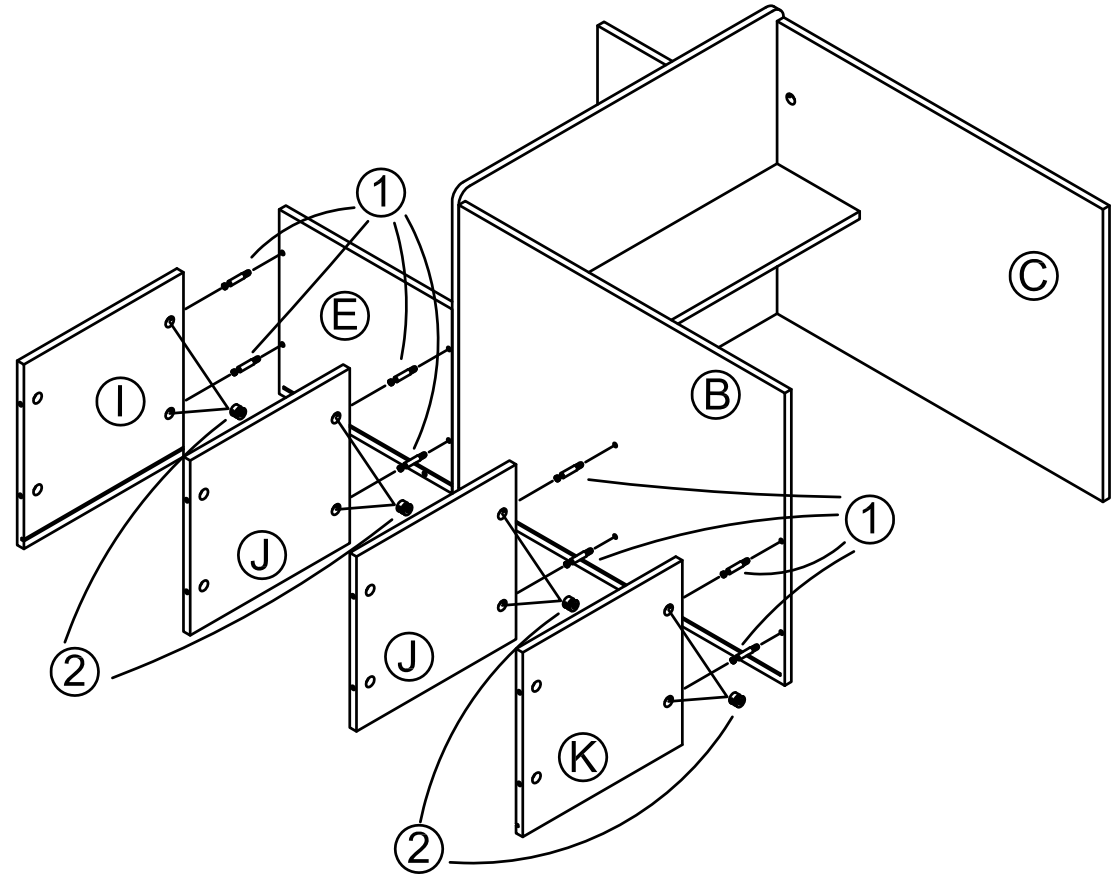
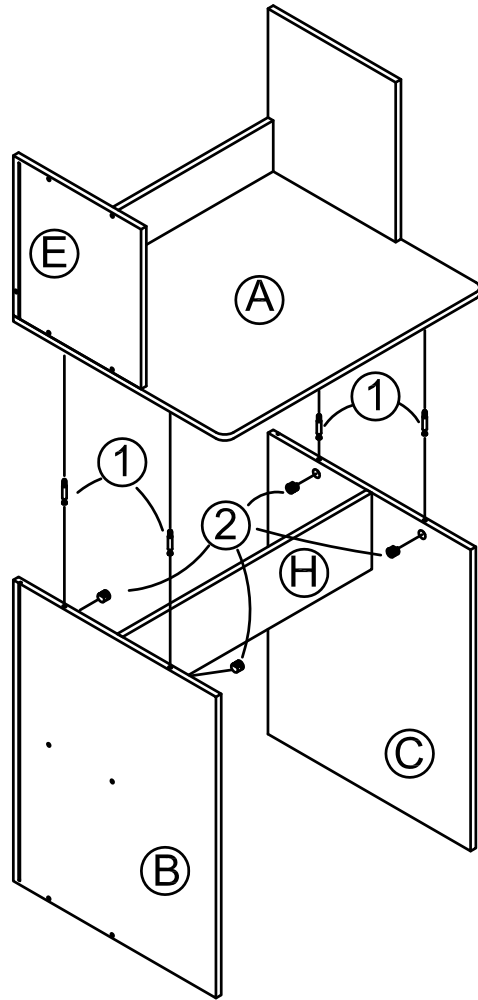

4

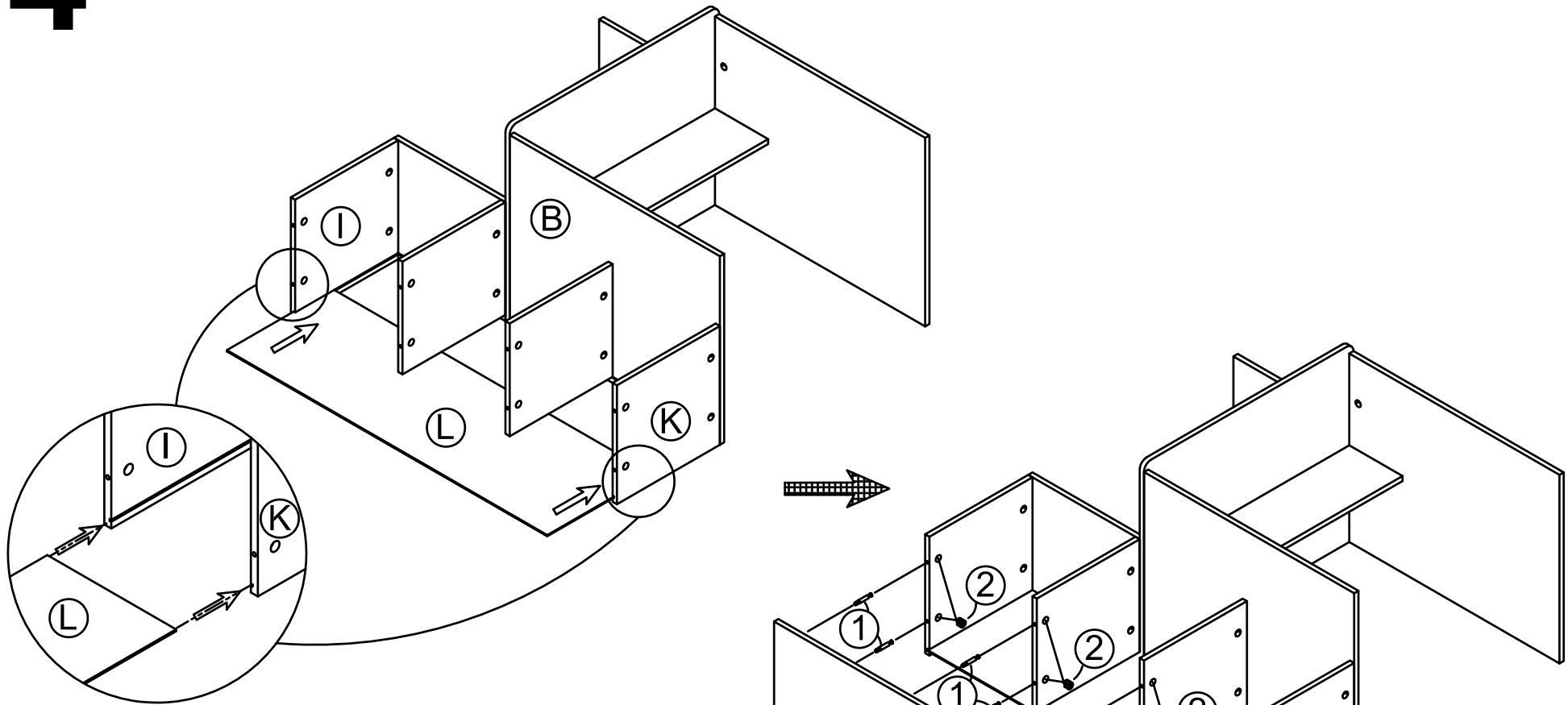

Ø6X35mm

①	x 8
---	-----

Ø15X10mm

②	x 8
---	-----

5

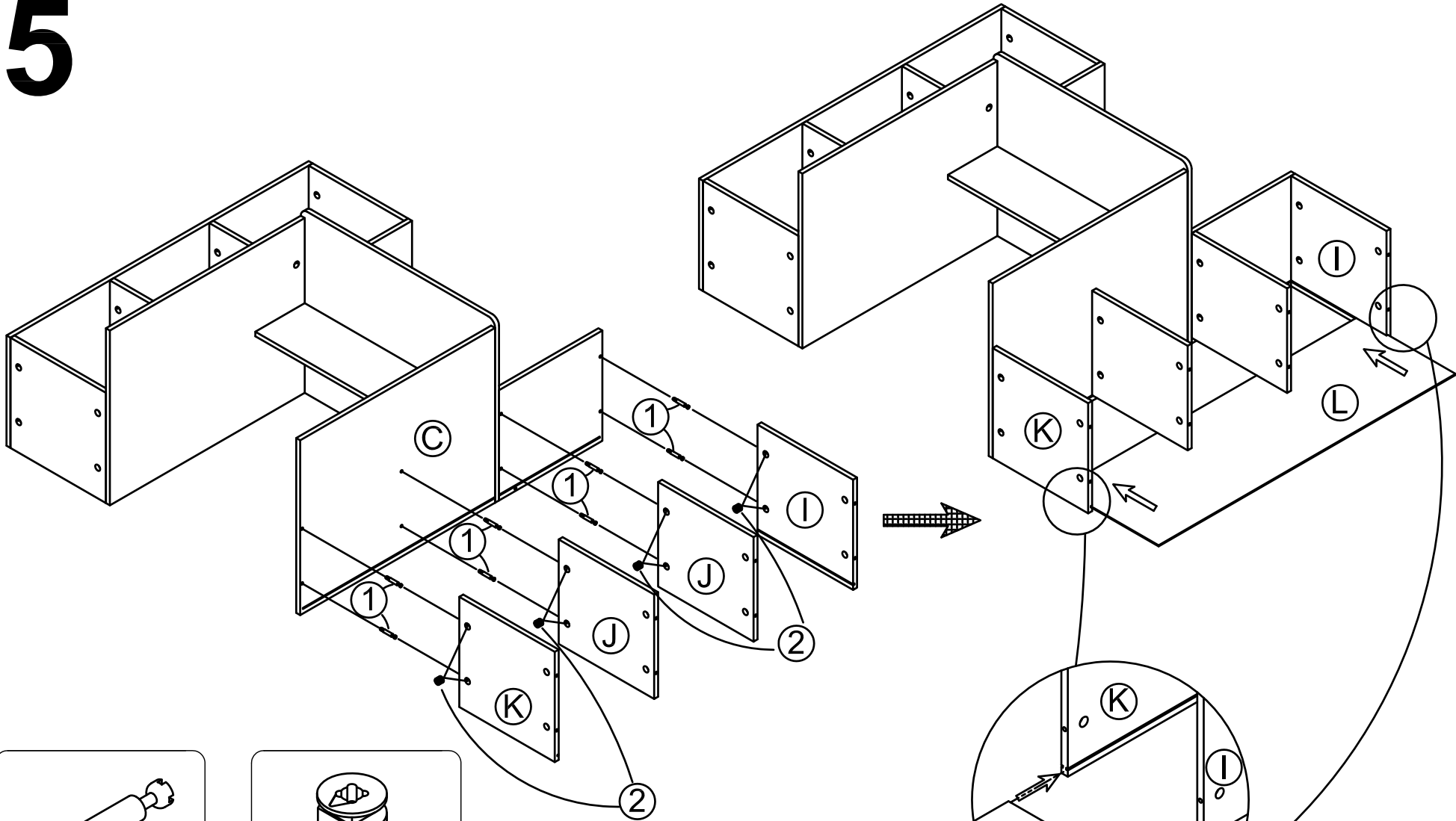

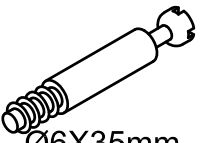
 Ø6X35mm	
①	x 8

 Ø15X10mm	
②	x 8

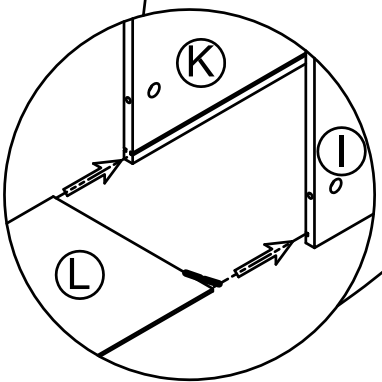

6

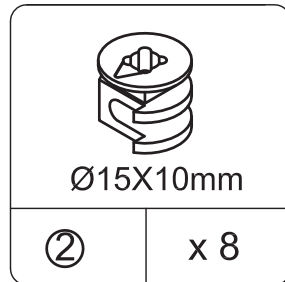
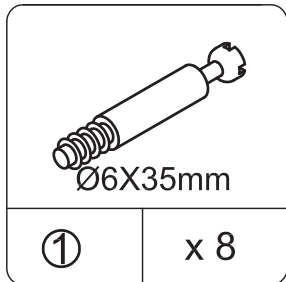
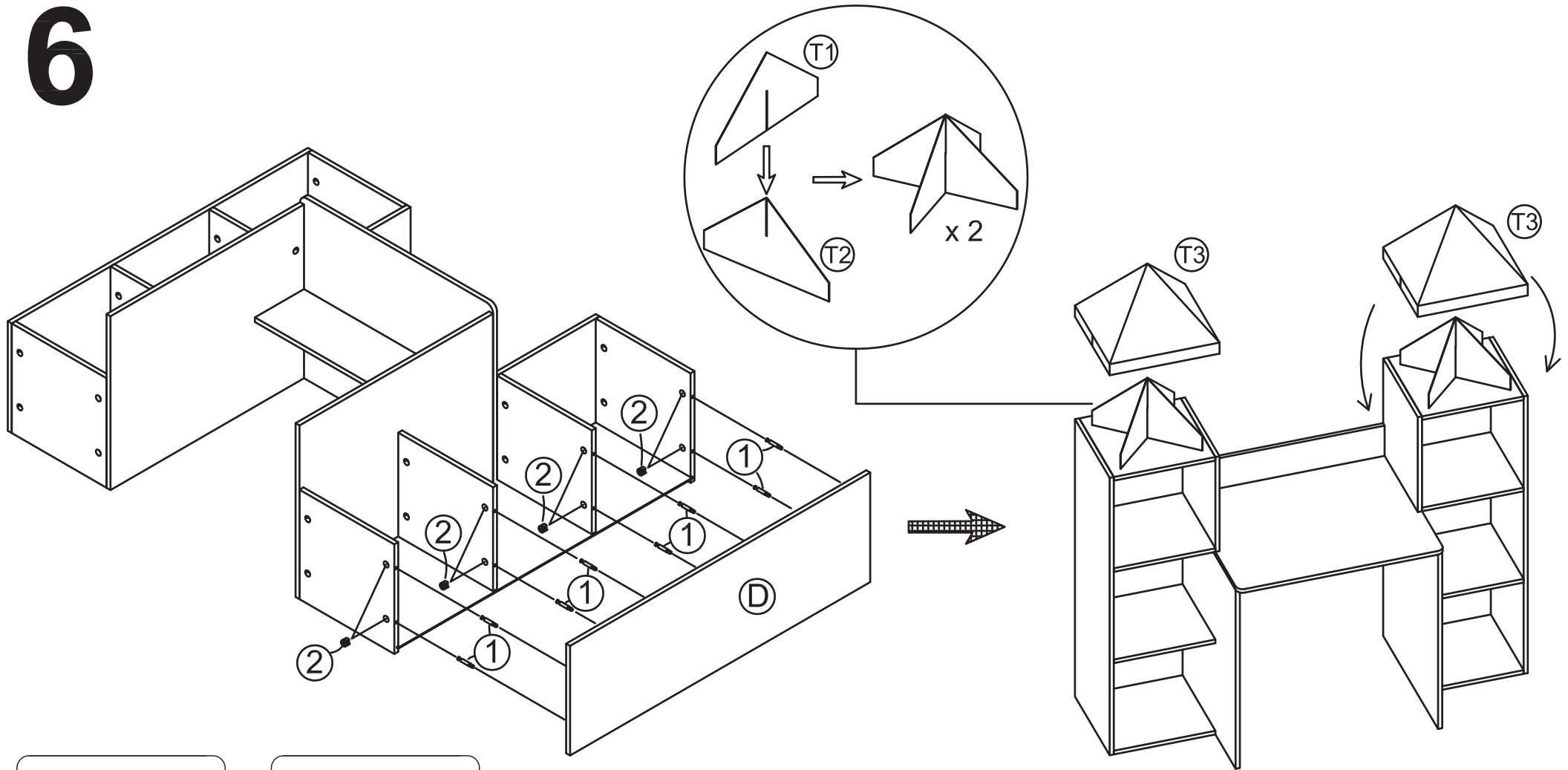

7

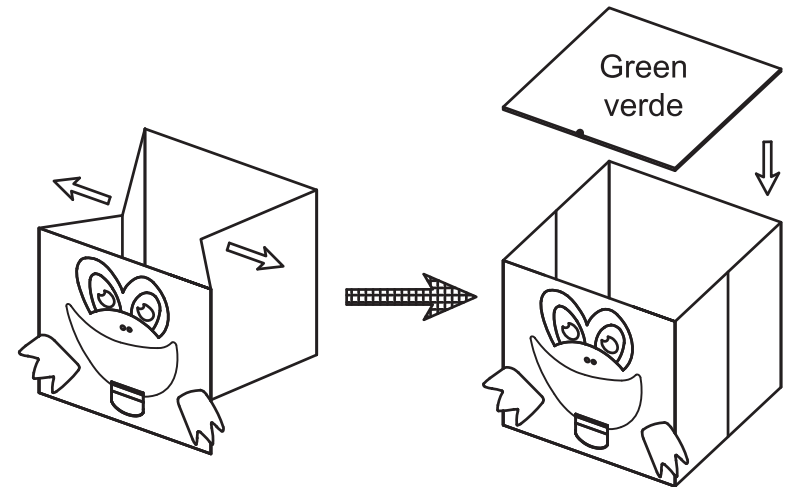
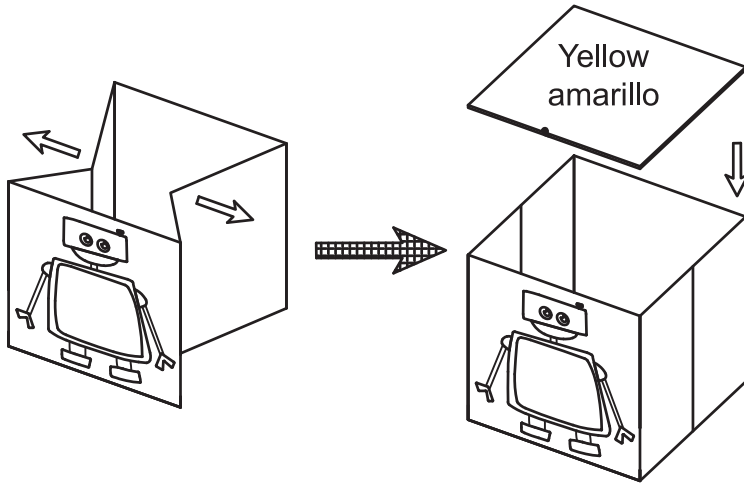
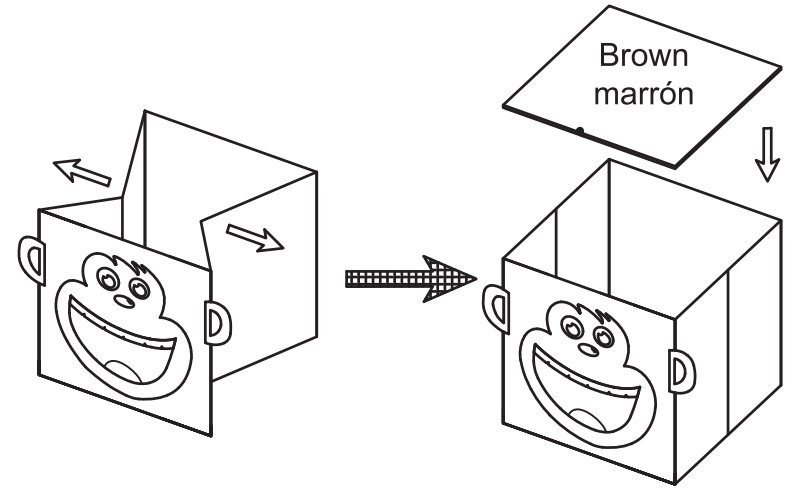
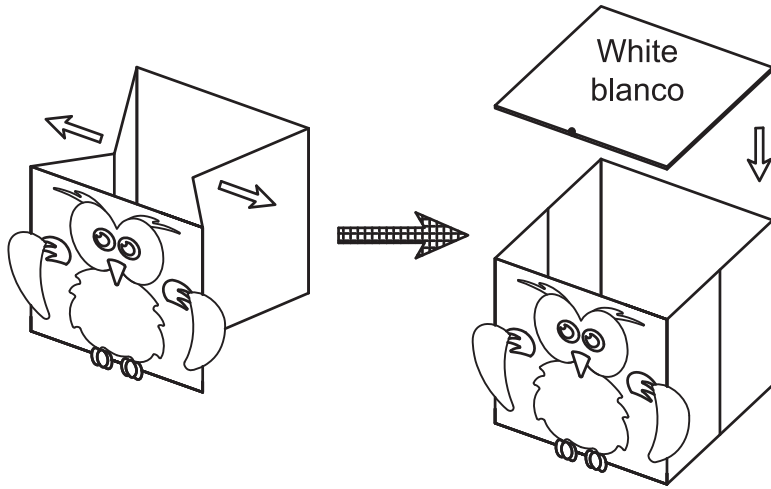

WEIGHT LIMITS:
LÍMITES DE PESO:

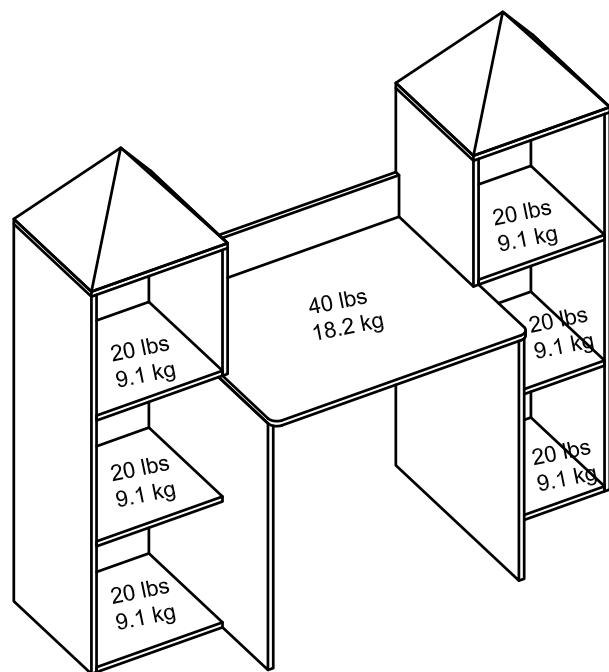

This unit has been designed to support the maximum loads shown.

Exceeding these load limits could cause sagging, instability, product collapse, and/or serious injury.

Esta unidad se ha diseñado para apoyar las cargas máxima se mostradas.

Exceder estos límites de carga podría causar ceder, inestabilidad, derrumbamiento del producto, y lesión seria.

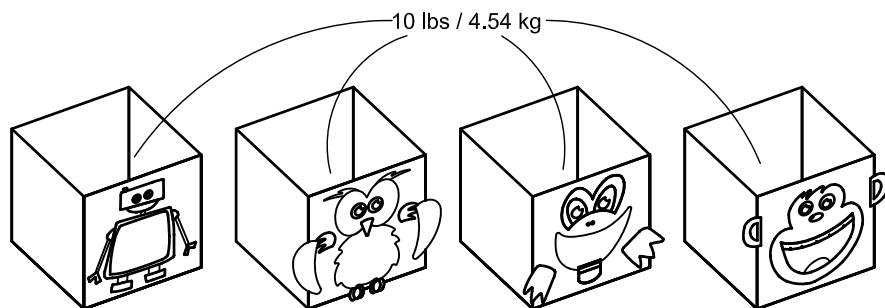

Enjoy Your Furniture
DISFRUTE DE SU MUEBLE

▲ WARNING

Please make sure that all objects are removed before moving the assembled unit.

The unit must be team lifted, not dragged or pushed. Failure to do so could cause instability, product collapse, and/or serious injury.

▲ ADVERTENCIA

Por favor mueva el mueble cuidadosamente con las ayuda de otra persona. levante y mueva el mueble a su lugar. no lo arrastre o empuje, de lo contrario puede haber inestabilidad en el mueble y este puede colapsar u ocasionar graves lesiones.