



**BESTAR**

**MODEL: MODÈLE: MODELO**

**47610-1139**

**BORDEAUX : BORDEAUX : BURDEOS**  
**WWW.BESTAR.CA : 1-888-8BESTAR (1 888 823-7827)**

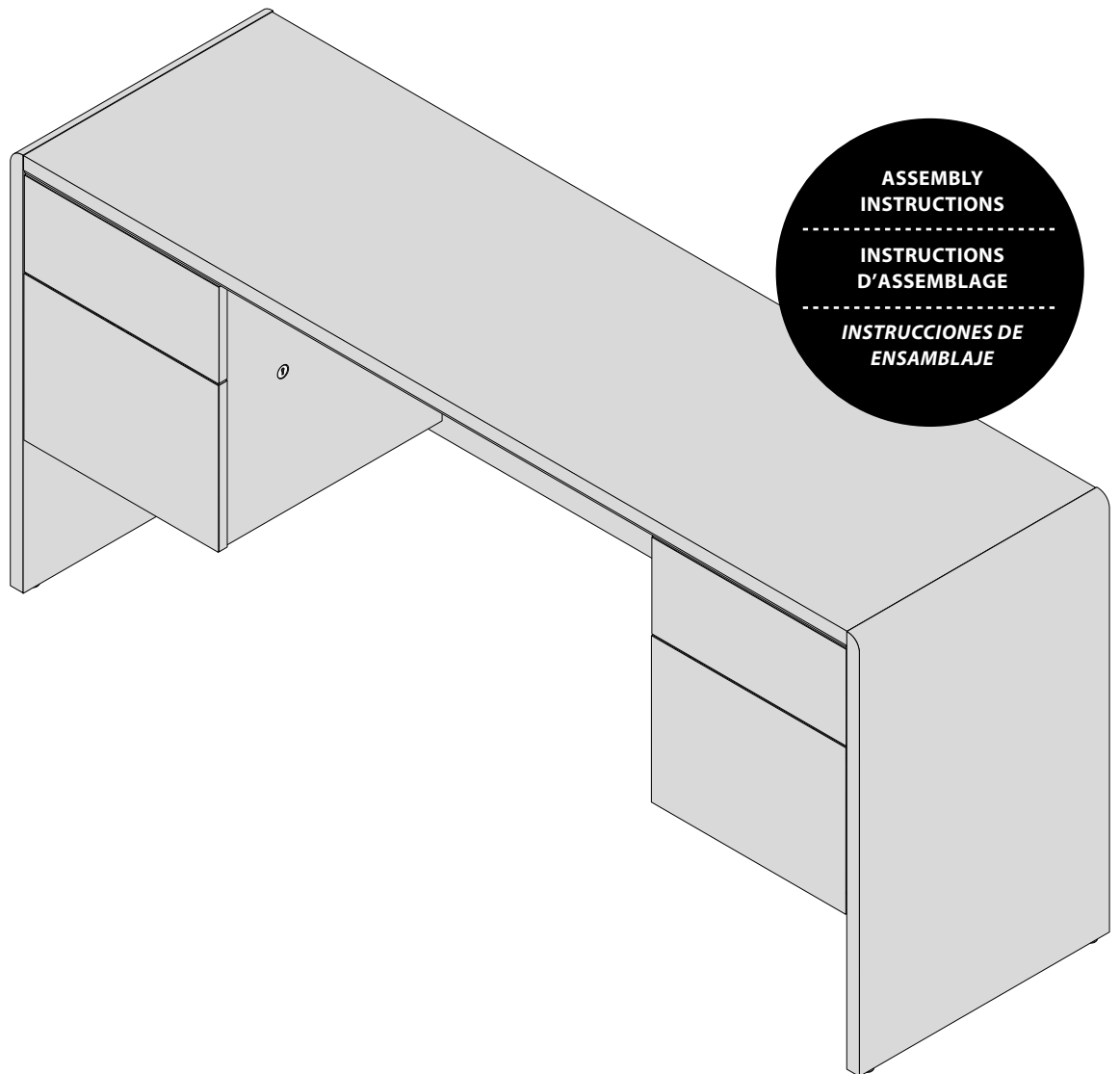

**ASSEMBLY  
INSTRUCTIONS**

**INSTRUCTIONS  
D'ASSEMBLAGE**

**INSTRUCCIONES DE  
ENSAMBLAJE**

## Thank you for choosing a BESTAR product. Your total satisfaction is our #1 priority.

### Customer service and warranty information

Should you have a problem or need more information concerning the warranty, **do not call to the place of purchase.**

**Please call our customer service department for immediate assistance using the following toll free number:**

Monday to Thursday: 8H00 AM to 6H00 PM E.S.T. / Friday: 8H00 AM to 4H00 PM E.S.T.

Please have your assembly instruction manual on hand when you call. BESTAR products are warranted to the original purchaser against defects in material or workmanship in the furniture. Defects as mentioned in this warranty refer to any imperfections which may impair the use of the product. Our warranty is expressly limited to the replacement of furniture parts and components for ten years following the date of purchase. BESTAR will replace any part that is defective. This warranty applies under conditions of normal use. Our furniture products are not intended for outdoor use. The warranty does not cover defects caused by improper assembly or disassembly, defects occurring after purchase due to product modifications, intentional damage, accident, misuse, exposure to the elements and labor or assembly costs. Bestar reserves the right to request proof of purchase to document a warranty claim. In no event shall BESTAR be liable for incidental or consequent damages resulting from the misuse of the product. This warranty is not transferable and is valid only in Canada and the United States excluding Alaska, Hawaii and Puerto Rico.



# www.bestar.ca

# 1 888 823-7827

## Merci d'avoir choisi les produits BESTAR. Vous satisfaire est notre priorité.

### Service à la clientèle et informations relatives à la garantie

Si vous rencontrez un problème ou si vous souhaitez de plus amples informations concernant votre garantie, **ne vous adressez pas au magasin où vous avez effectué votre achat. Pour obtenir une aide immédiate, veuillez appeler notre service après-vente au numéro sans frais :**

Lundi au jeudi : 8H00 à 18H00 HNE / Vendredi : 8H00 à 16H00 HNE

Veillez avoir en main le manuel d'instructions lors de votre appel. La garantie des produits BESTAR est valide, pour l'acheteur original, en cas de défaut de matériel ou de fabrication. Les défauts couverts par cette garantie incluent toutes les imperfections qui ont pour conséquence une utilisation non appropriée du produit. Notre garantie est expressément limitée au remplacement des composants et des éléments de meubles pour une durée de dix ans suivant la date de l'achat. BESTAR s'engage à remplacer tout élément défectueux. Cette garantie s'inscrit dans le cadre d'une utilisation du produit dans des conditions normales. Nos meubles ne sont pas destinés à être utilisés à l'extérieur. La garantie ne couvre pas les défauts générés par un assemblage ou un démontage non conforme, les défauts apparus suite à des modifications apportées au produit, à des dommages intentionnels, à un accident, une mauvaise utilisation, l'utilisation à l'extérieur, ni les coûts de main d'œuvre ou d'assemblage. Bestar se réserve le droit d'exiger une preuve d'achat afin de documenter la réclamation. La société BESTAR ne pourra être tenue, en aucun cas, responsable de dommages indirects ou consécutifs, suite à une mauvaise utilisation du produit. Cette garantie ne peut être transférée et est valide au Canada et aux États-Unis sauf Hawaï, Puerto Rico et Alaska.

## Gracias por elegir un producto BESTAR. Su entera satisfacción es nuestra prioridad N°1.

### Servicio de atención al cliente e información sobre la garantía

Si tiene algún problema y necesita más información sobre la garantía, no vaya al lugar donde realizó la compra. **Llame a nuestro departamento de atención al cliente para recibir ayuda inmediata utilizando nuestro servicio de llamada gratuita :**

De lunes a jueves : de 8H00 AM a 6H00 PM EST / Viernes : de 8h00 AM a 4H00 PM EST

Cuando llame, tenga a mano su manual de instrucciones de montaje. Los productos BESTAR están garantizados por el comprador original contra defectos en el material o en la confección del mueble. Los defectos, tal como se describen en esta garantía incluyen toda imperfección que pueda impedir el uso del producto. Nuestra garantía se limita expresamente al reemplazo de las partes y componentes del mueble defectuosos por diez años a partir de la fecha de compra. BESTAR reemplazará cualquier pieza defectuosa. Esta garantía se aplica según las condiciones de uso normal. Nuestros productos no están diseñados para ser utilizados al aire libre. La garantía no cubre defectos provocados por ensamblaje o desensamblaje incorrectos, defectos ocurridos luego de la compra por la modificación del mueble, daños intencionales, accidentes, uso incorrecto, exposición a los agentes naturales ni costos derivados de la fabricación o ensamblaje. Bestar se reserva el derecho de solicitar una factura de compra para poder extender un reclamo de garantía. Bajo ninguna circunstancia BESTAR será responsable de los daños accidentales o consecuentes que pudieran resultar del uso incorrecto del producto. Esta garantía es intransferible y se aplica solamente a Canadá y los Estados Unidos.

► PARTS / PIÈCES / PIEZAS

CODE / CÓDIGO	QTY / QTÉ / CANT.	CODE / CÓDIGO	QTY / QTÉ / CANT.	CODE / CÓDIGO	QTY / QTÉ / CANT.	CODE / CÓDIGO	QTY / QTÉ / CANT.
CA03A	4	17	1	40	1	<b>bottom / fond / fondo</b> 15 3/8" x 12 1/2" (391 mm x 316 mm)	4
CA05A	4	18	1	66	2	<b>molding / moulure / moldura</b> 63 7/8" x 5/8" (1622 mm x 16 mm)	1
CA09A	4	30	1	67	2		
CA13A	4	31	1	70	1		

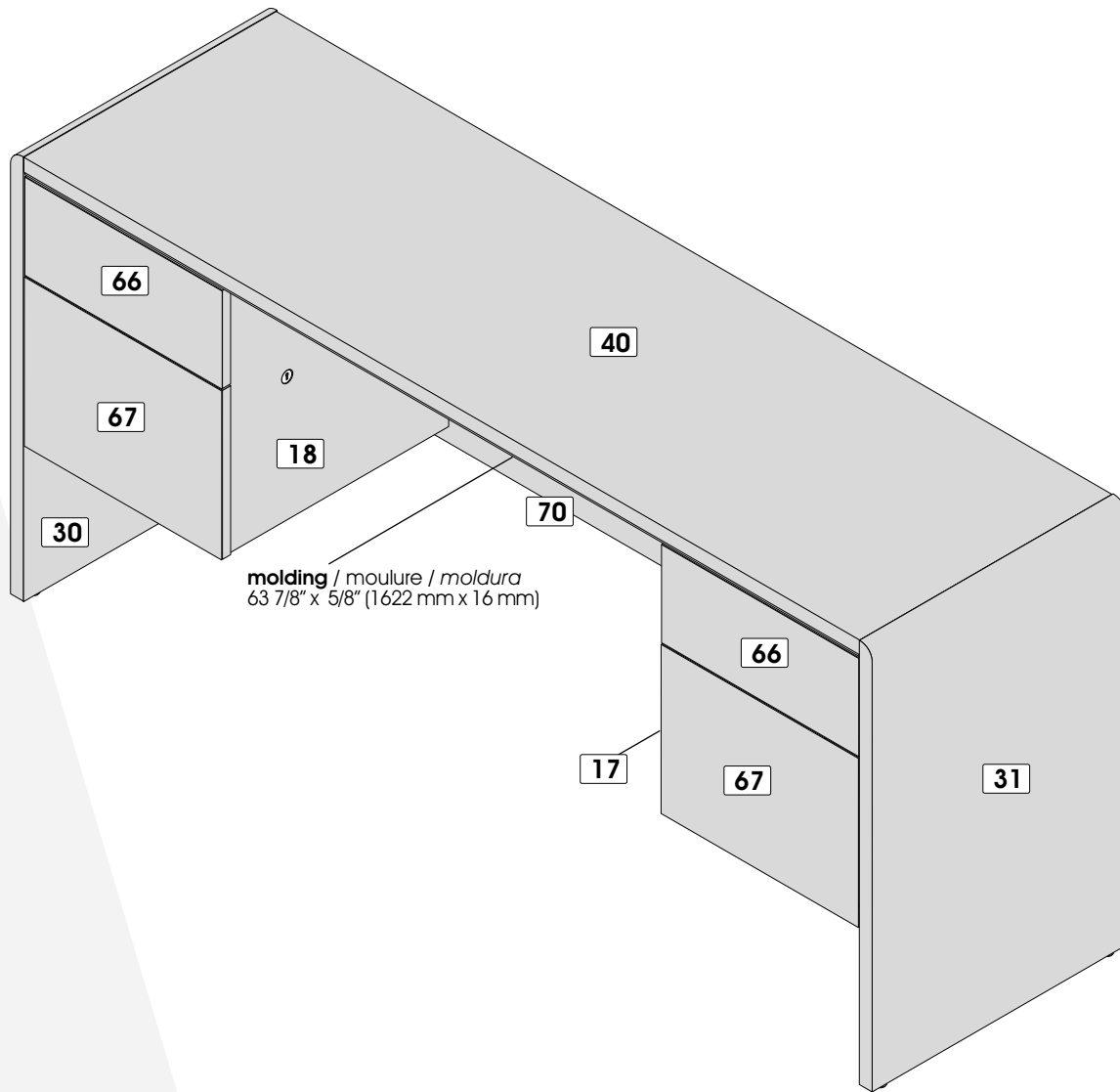

**two people are required to assemble and move this model.**

deux personnes sont requises pour assembler et déplacer ce modèle.

se necesitan dos personas para ensamblar y desplazar este mueble.

**the use of electric tools must be made with vigilance.**

l'utilisation d'outils électriques doit être faite avec vigilance.







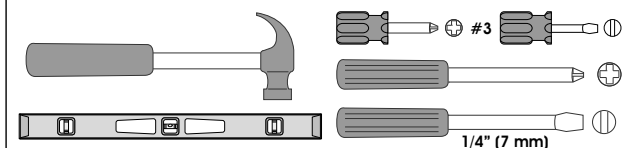



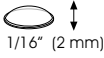

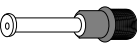
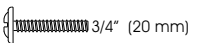



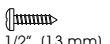

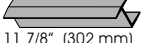
las herramientas eléctricas deben utilizarse con sumo cuidado.

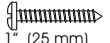
**tools required**

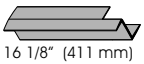

outils requis  
herramientas necesarias

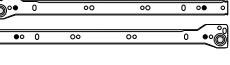

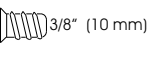
**HARDWARES / QUINCAILLERIES / QUINCALLAS**

CODE / CÓDIGO	QTY / QTÉ / CANT.	CODE / CÓDIGO	QTY / QTÉ / CANT.	CODE / CÓDIGO	QTY / QTÉ / CANT.	CODE / CÓDIGO	QTY / QTÉ / CANT.
AM-182 	4	EC-744 	8	H-36 	10	VM-601 	8
CA-99 	8	EQ-314 	4	PA-844 	4	VR-207 	40
CL-745 	1	EX-681 	4	PF-108 	1	VR-212 	32
CR-141 	4	EX-702 	4	SE-686 	2		
CO-249 	2	H-03 	16	RU-750 	2		
CO-762 	2	H-04 	6	VE-244 	20		

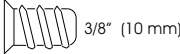
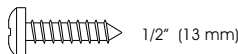
**REAL SIZE / GRANDEUR RÉELLE / TAMAÑO REAL**

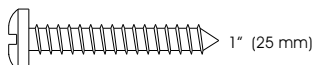
CODE / CÓDIGO	QTY / QTÉ / CANT.	CODE / CÓDIGO	QTY / QTÉ / CANT.
VE-244 	20	VR-207 	40
VM-601 	8	VR-212 	32

**IMPORTANT NOTICE / NOTE IMPORTANTE / NOTA IMPORTANTE**

**Group together all the hardware required for each step as the construction of your piece of furniture is progressing.**

Regroupez toutes les quincailleries requises pour chaque étape de façon à vous assurer de tout installer au bon moment.

Reúna todas las quincallas necesarias para cada una de las etapas de montaje, para asegurar una correcta instalación en el momento adecuado.

**IMPORTANT NOTICE / NOTE IMPORTANTE / NOTA IMPORTANTE**

**Main hardware system / Système de quincaillerie principal / Sistema principal de quincalla**

**1**  
H-36

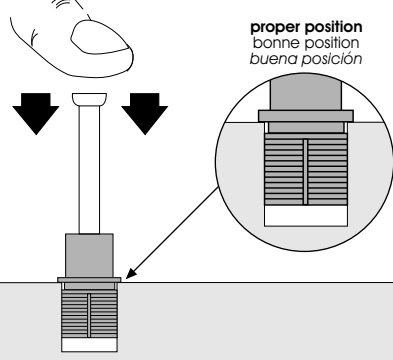

**proper position**  
bonne position  
buena posición

**2**  
H-03

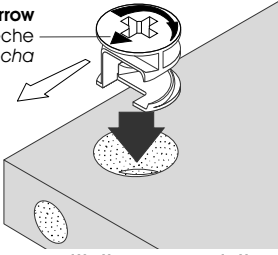

**arrow**  
flèche  
flecha

**Insert the cam with the arrow pointing towards the hole in the edge.**  
Insérez la rondelle en pointant la flèche vers le trou de la bordure.  
Inserte la arandela apuntando la flecha hacia el orificio cercano el borde.

**If needed / En cas de nécessité / En caso de necesidad**

**How to remove a misplaced assembly bolt (H-36).**  
Comment retirer un boulon (H-36) mal situé.  
Cómo retirar un perno (H-36) mal ubicado.

**A**

**turn**  
tournez  
haga girar

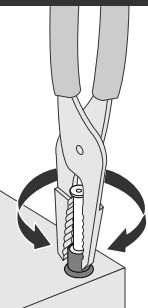

**B**

**pull out**  
retirez  
retire

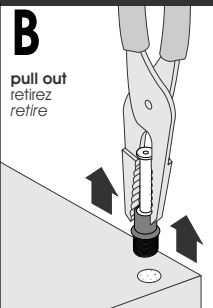

**Important/Importante**

**Make sure to use the largest holes in runner (CO-762), as indicated below.**

Assurez-vous d'utiliser les plus gros trous du coulisseau (CO-762), tel qu'indiqué ci-dessous.

Utilice los agujeros más grandes de la guía (CO-762), como se indica a continuación.

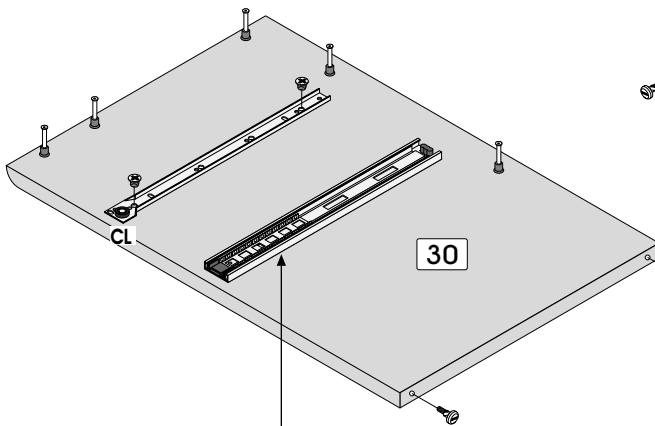
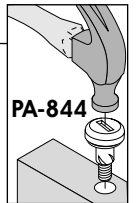
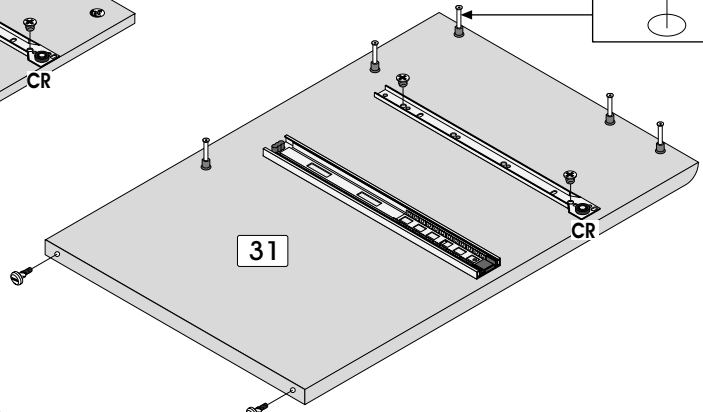
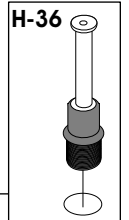
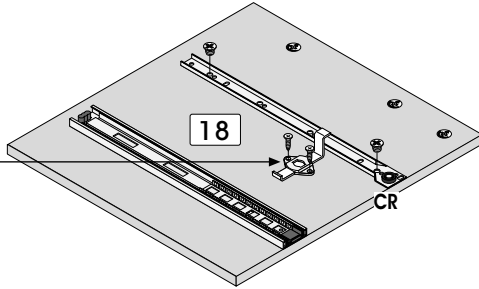
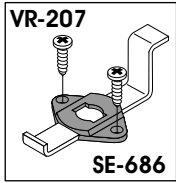
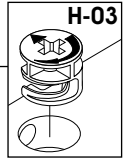
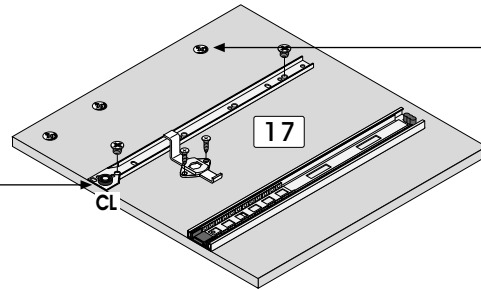
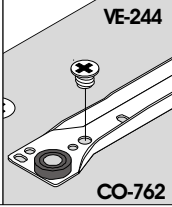

**CO-249** Use these holes / Utilisez ces trous / Utilice estos orificios

Push plastic lever and slide out piece to be used for parts CA09A & CA01A in step 5  
 Soulever pour dégager et séparer la section qui servira pour les pièces CA09A et CA01A à l'étape 5  
 Levantar para soltar y separar la sección que servirá para las piezas CA09A Y CA01A a la etapa 5

Code / Código	H-03	H-36	PA-844	SE-686	VR-207	VE-244	CO-249	CO-762
Qty / Qté / Cant.	x 6	x 10	x 4	x 2	x 4	x 20	x 2	x 2

**2** **HARDWARE INSTALLATION / INSTALLATION DES QUINCAILLERIES / INSTALACIÓN DE LAS QUINCALLAS**

**CREENZA / CRÉDENCE / CREDENCIA**

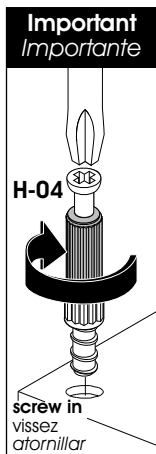
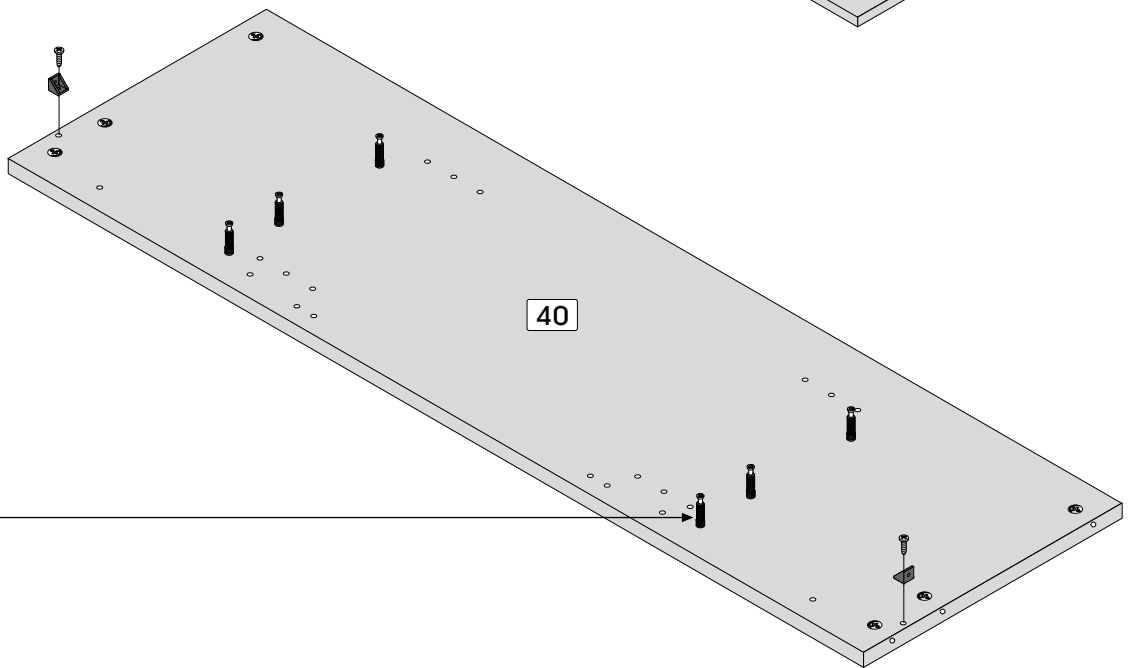
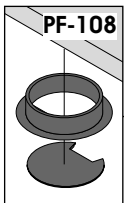
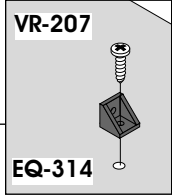
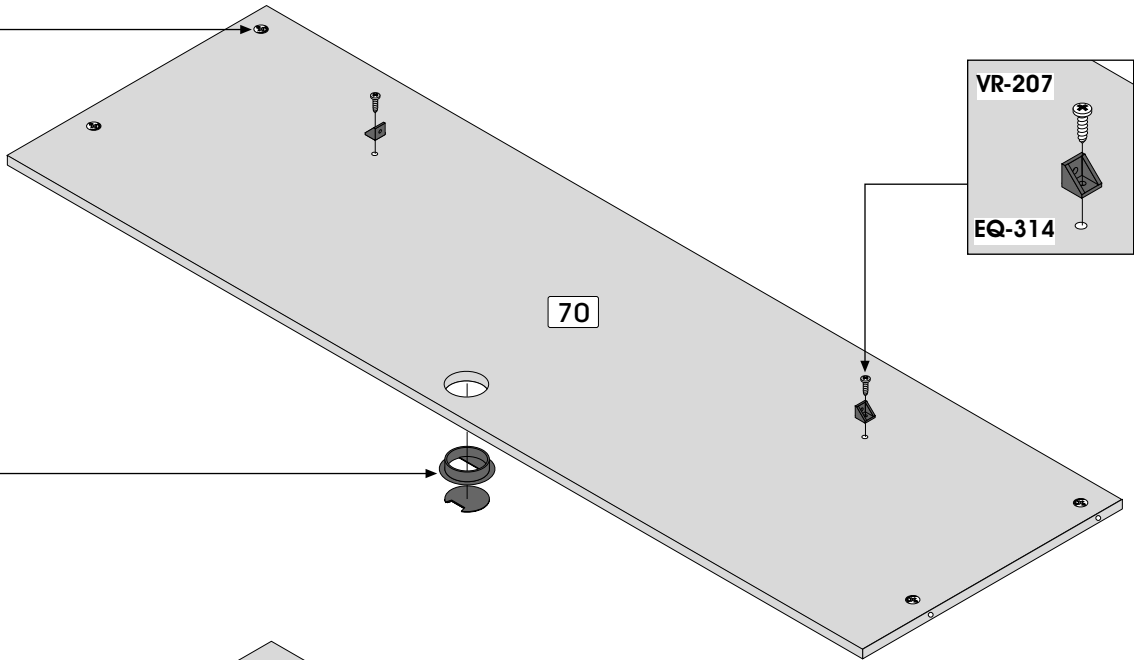
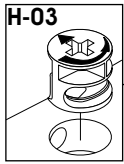

**2**

<b>Code / Código</b>	H-03	PF-108	H-04	EQ-314	VR-207
<b>Qty / Qté / Cant.</b>	x 10	x 1	x 6	x 4	x 4

**SERVICE/SERVICIO: 1-888 8BESTAR (1-888 823-7827)**

**IMPORTANT NOTICE / NOTE IMPORTANTE / NOTA IMPORTANTE**

▶ **Main hardware system / Système de quincaillerie principal / Sistema principal de quincalla**

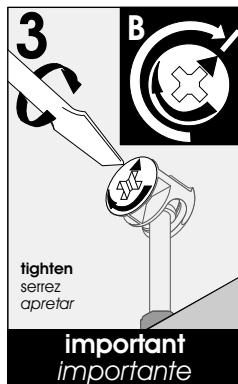
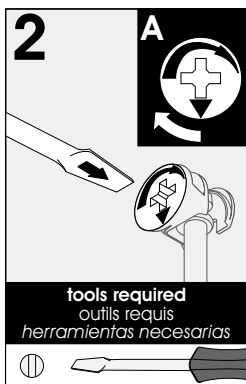
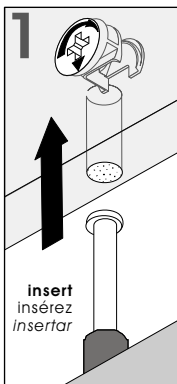

**Make sure to properly tighten each cam to ensure furniture solidity. Otherwise, parts could be damaged or the user could be injured.**

Assurez-vous de bien resserrer chaque rondelle pour assurer la solidité du meuble. Dans le cas contraire, des pièces pourraient être endommagées ou l'utilisateur pourrait se blesser.

Asegúrese de apretar bien cada arandela para garantizar la solidez del mueble. De lo contrario, podría provocarse daño a las piezas o las personas.

**3 PRE-ASSEMBLY / PRÉ-ASSEMBLAGE / PREENSAMBLAJE**

**CREDENZA / CRÉDENCE / CREDENCIA**

**Assembling sequence**  
 Séquence d'assemblage  
 Secuencia de ensamblaje  
**Parts / Pièces / Piezas:**

**Assemble upside down**  
 Assemblez en position renversée  
 Realice el ensamblaje en posición invertida

**31 40 70 30 + VR-207**

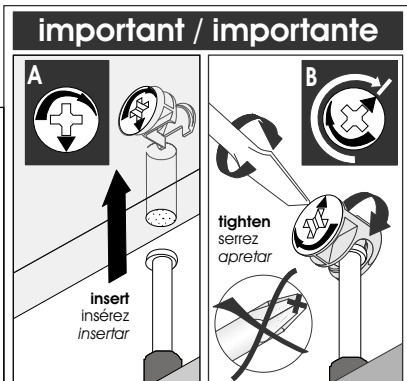
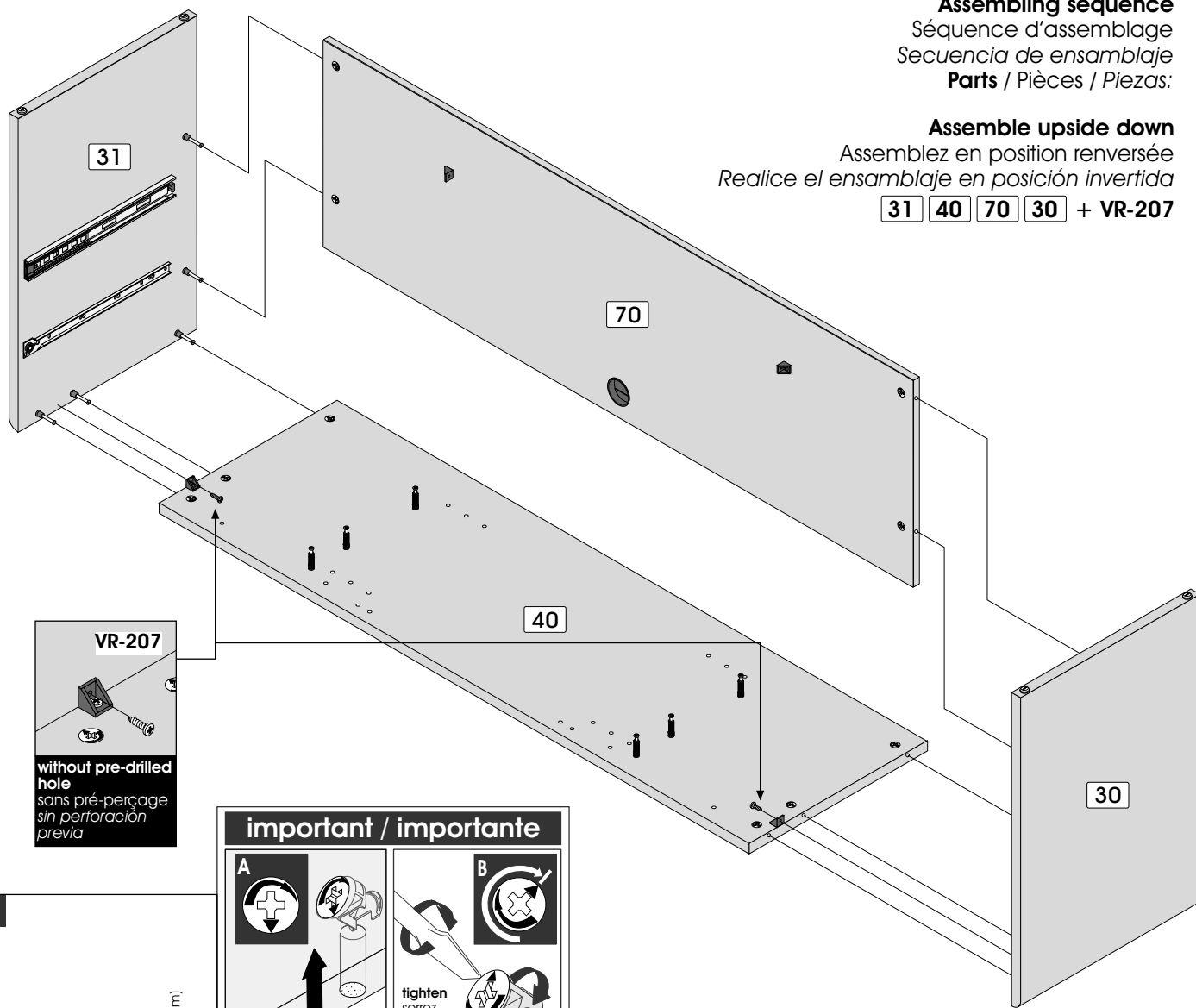

**3**

 1/2" (13 mm)

**Code / Código** VR-207

**Qty / Qté / Cant.** x 2

**Assemble upside down**

Assemblez en position renversée

Realice el ensamblaje en posición invertida

**Assembling sequence**

Séquence d'assemblage

Secuencia de ensamblaje

Parts / Pièces / Piezas:

**40 70** + **17 18** + **VR-207** + **molding / moulure / moldura**

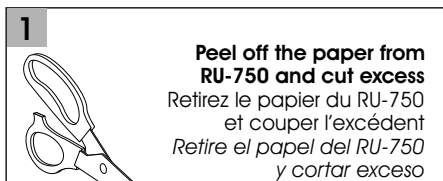
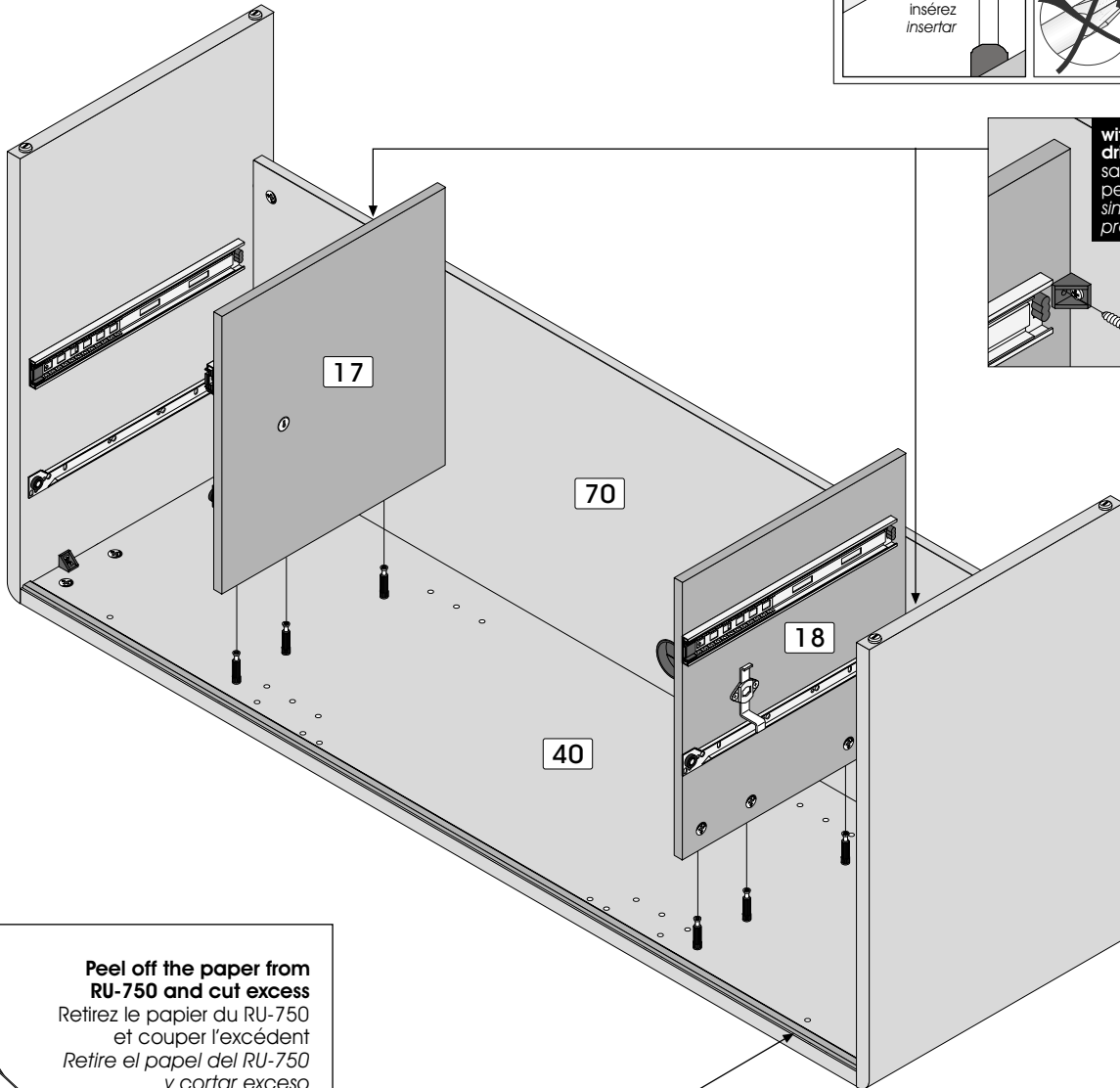
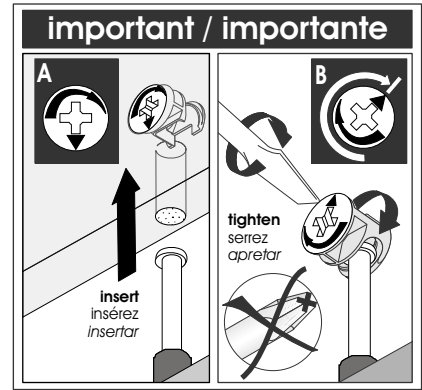

**Peel off the paper from RU-750 and cut excess**  
Retirez le papier du RU-750 et coupez l'excédent  
Retire el papel del RU-750 y cortar exceso

**molding / moulure / moldura**  
63 7/8" x 5/8" (1622 mm x 16 mm)

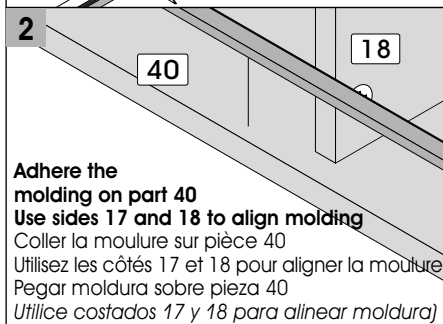

**Adhere the molding on part 40**  
**Use sides 17 and 18 to align molding**  
Coller la moulure sur pièce 40  
Utilisez les côtés 17 et 18 pour aligner la moulure  
Pegar moldura sobre pieza 40  
Utilice costados 17 y 18 para alinear moldura

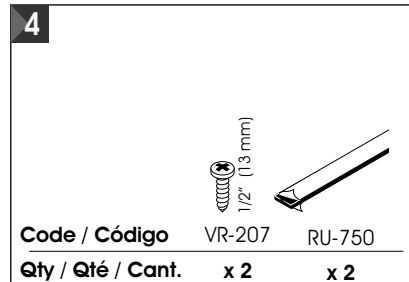



# 5 HARDWARE INSTALLATION / INSTALLATION DES QUINCAILLERIES / INSTALACIÓN DE LAS QUINCALLAS

## Drawers / Tiroirs / Cajones

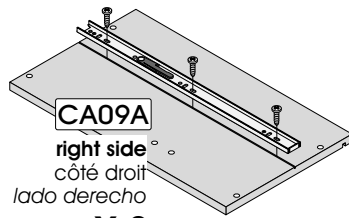
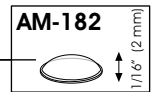
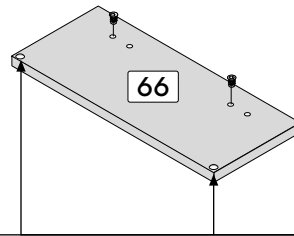
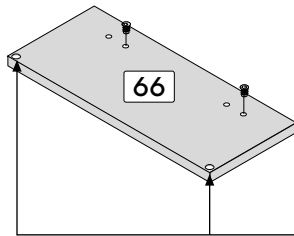
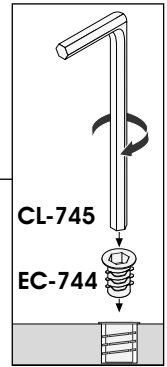
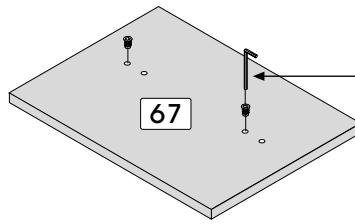
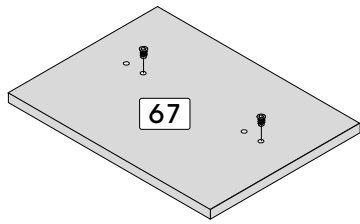

**CA09A**  
right side  
côté droit  
lado derecho  
**X 2**

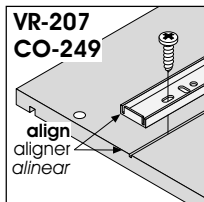

**VR-207**  
**CO-249**

align  
aligner  
alineara

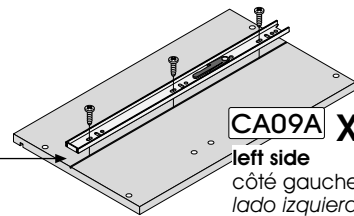

**CA09A X 2**  
left side  
côté gauche  
lado izquierdo

### 5

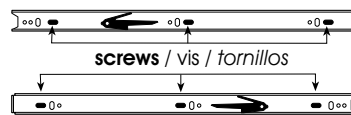

screws / vis / tornillos

**CO-249**



**VR-207**  
1/2" (13 mm)

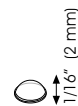

**AM-182**  
1 7/16" (2 mm)

Code / Código

EC-744

CL-745

Qty / Qté / Cant.

x 8

x 1

x 2

x 12

x 4

SERVICE/SERVICIO: 1-888 8BESTAR (1-888 823-7827)

**Left drawer / Tiroir gauche / Cajón izquierdo**

**Assembling sequence**

Séquence d'assemblage

Secuencia de ensamblaje

Parts / Pièces / Piezas:

**CA05A CA03A CA03A** + **bottom / fond / fondo** + **CA05A 66**

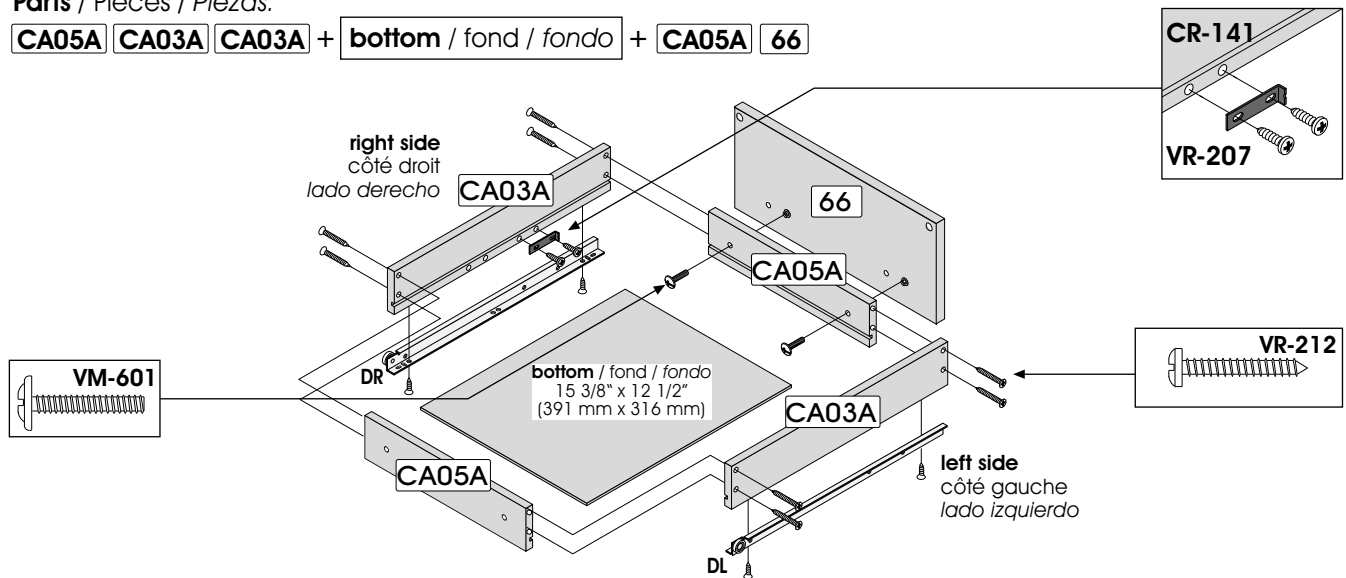

**Right drawer / Tiroir droit / Cajón derecho**

**Assembling sequence**





Séquence d'assemblage

Secuencia de ensamblaje

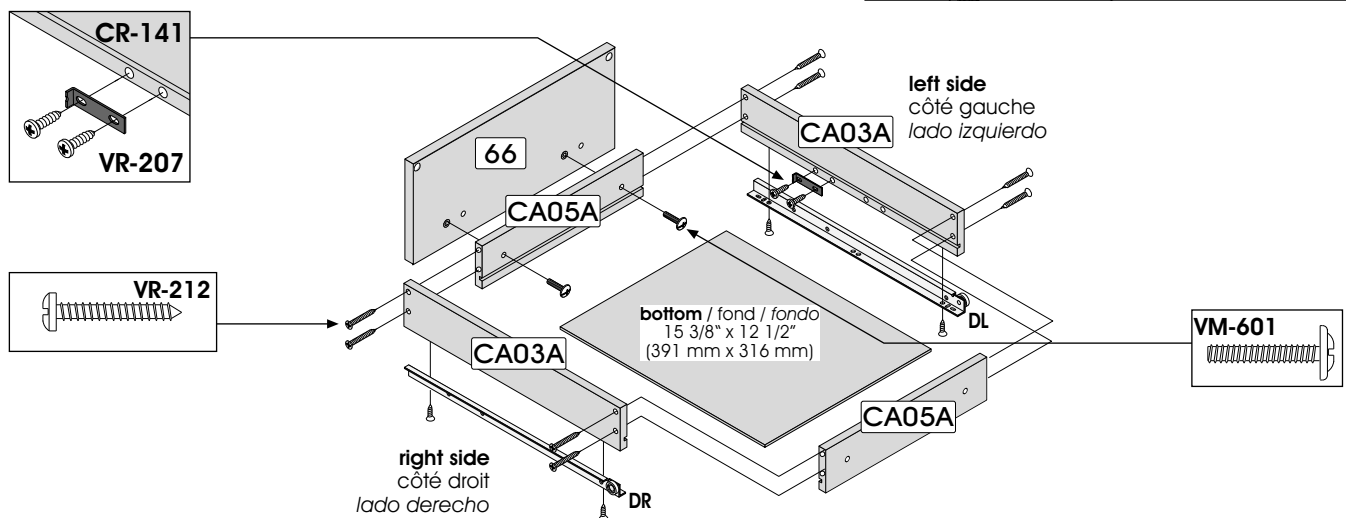
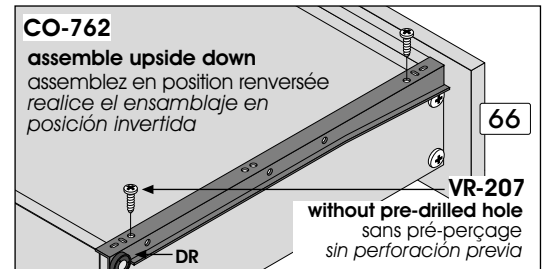
Parts / Pièces / Piezas:

**CA05A CA03A CA03A** + **bottom / fond / fondo** + **CA05A 66**

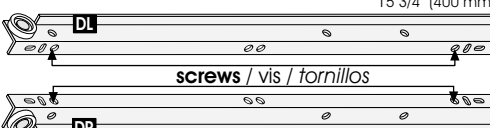

					
Code / Código	VM-601	VR-212	CR-141	VR-207	CO-762
Qty / Qté / Cant.	x 4	x 16	x 2	x 12	x 2

Left drawer / Tiroir gauche / Cajón izquierdo

Assembling sequence

Séquence d'assemblage  
Secuencia de ensamblaje

Parts / Pièces / Piezas:

CA13A EX-681 CA09A EX-702 CA09A EX-702 +  
bottom / fond / fondo + CA13A EX-681 67

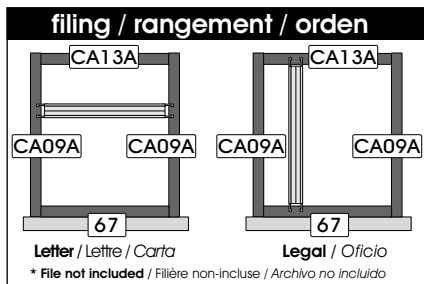
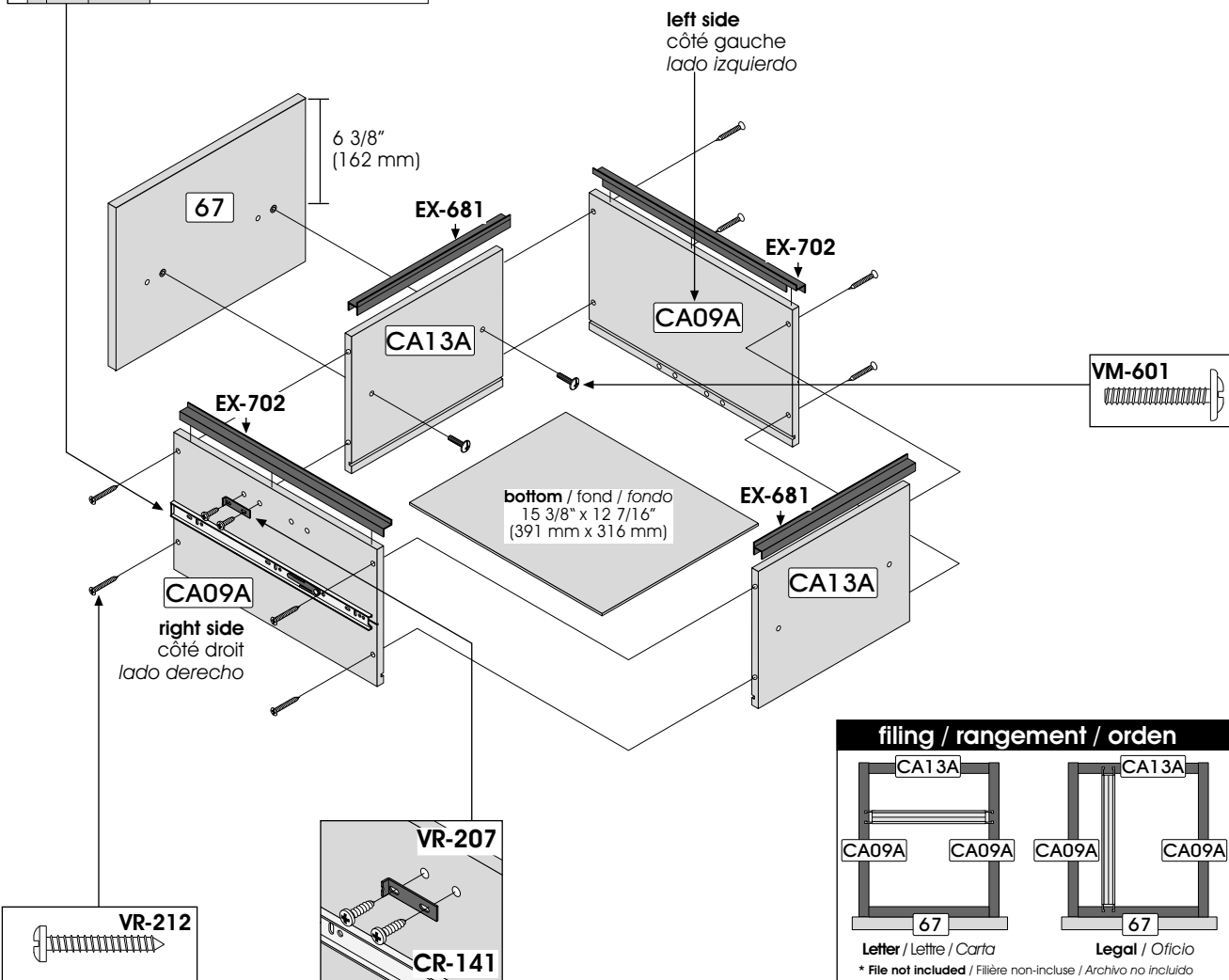
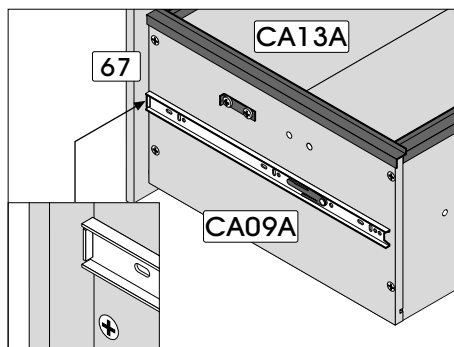

Code / Código	EX-681	EX-702	VM-601	VR-212	CR-141	VR-207
Qty / Qté / Cant.	x 2	x 2	x 2	x 8	x 1	x 2

**Inferior Drawer / Tiroir inférieur / Cajón inferior**

**Right drawer / Tiroir droit / Cajón derecho**

**Assembling sequence**





Séquence d'assemblage  
Secuencia de ensamblaje

Parts / Pièces / Piezas:

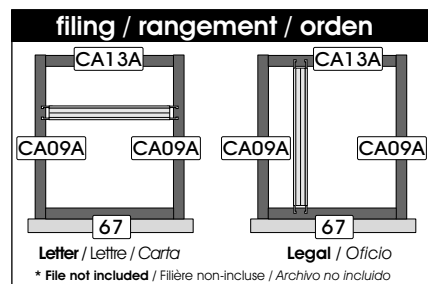
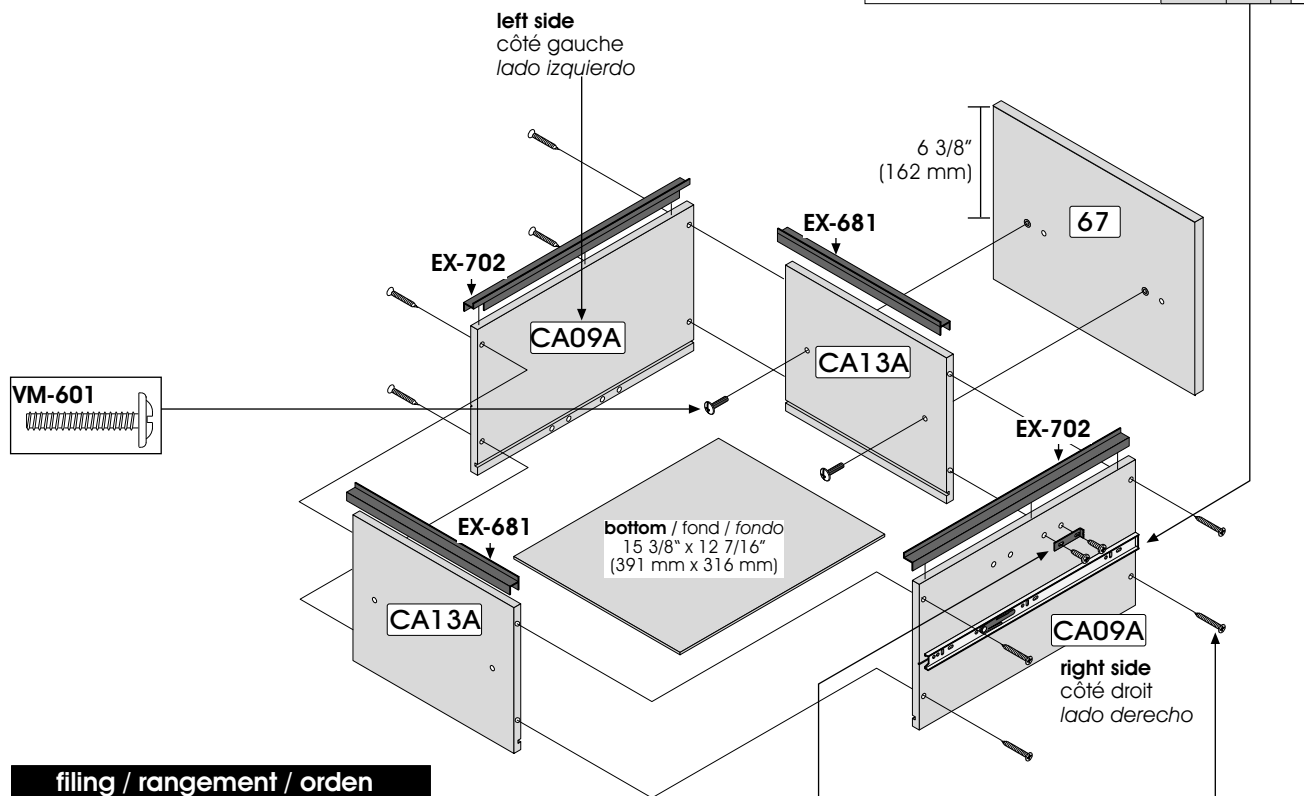
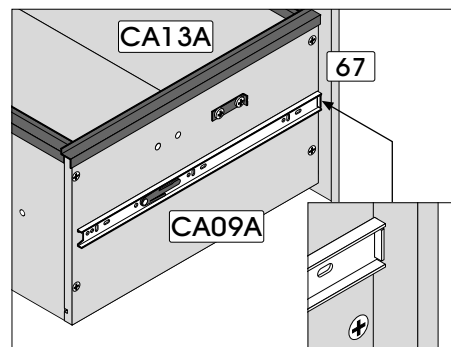
**CA13A** **EX-681** **CA09A** **EX-702** **CA09A** **EX-702** +

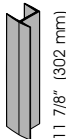
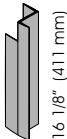
**bottom / fond / fondo** + **CA13A** **EX-681** **67**



						
<b>Code / Código</b>	EX-681	EX-702	VM-601	VR-212	CR-141	VR-207
<b>Qty / Qté / Cant.</b>	x 2	x 2	x 2	x 8	x 1	x 2

**To level your furniture, use leg levelers.**

Pour niveler votre meuble utilisez les pattes ajustables.  
Para nivelar su mueble utilice las patas ajustables.

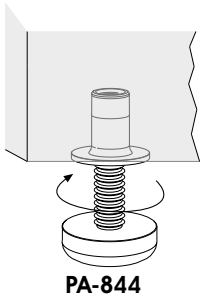

PA-844

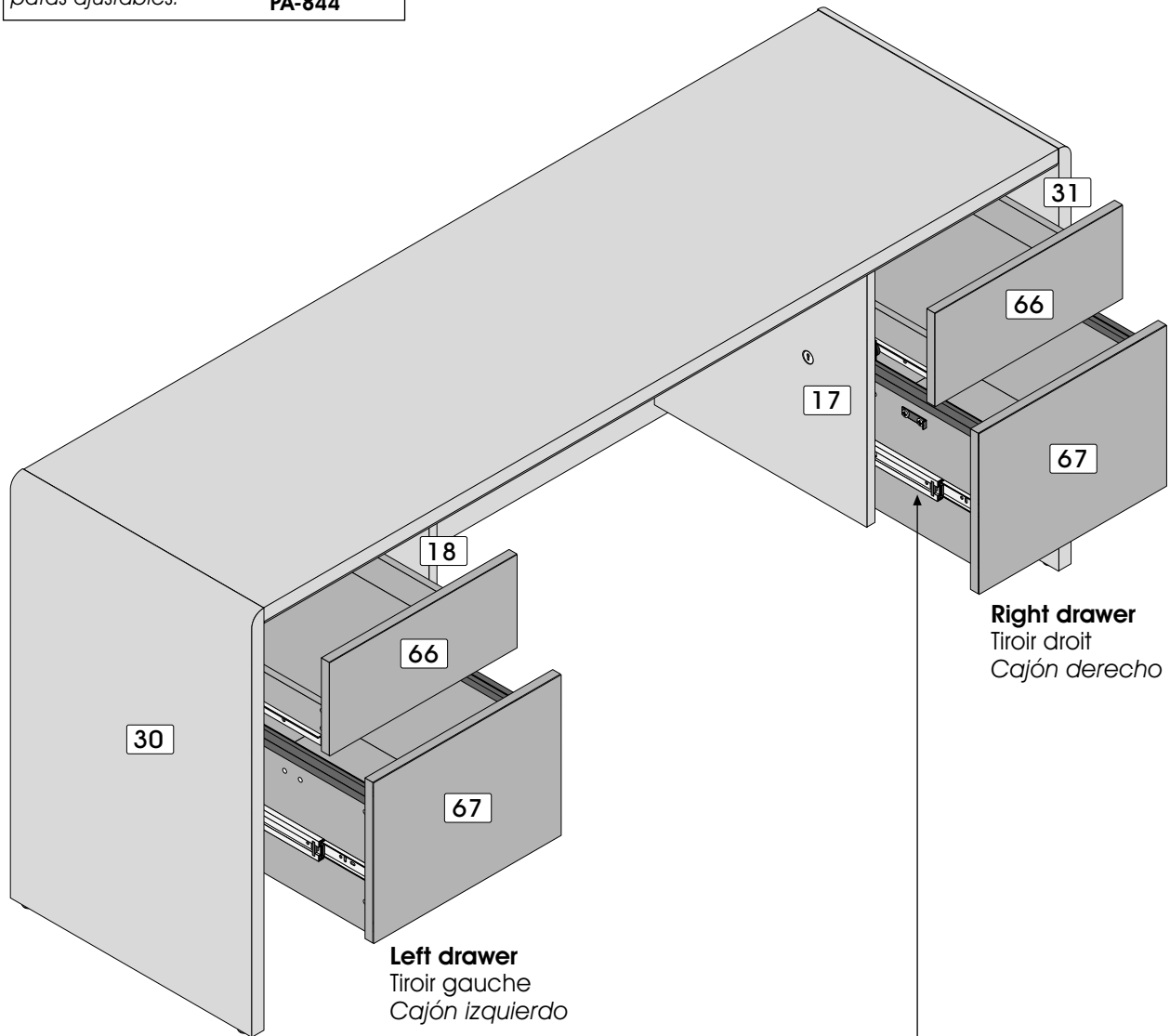

**Left drawer**  
Tiroir gauche  
Cajón izquierdo

**Right drawer**  
Tiroir droit  
Cajón derecho

### Important/Importante

**Ball bearings must be on front part of slider when installing drawers.**

Les roulements à billes doivent être sur la partie avant du coulisseau lors de l'installation des tiroirs.

Los cojinetes de bolas deben ubicarse sobre la parte delantera de guía en el momento de instalar los cajones.

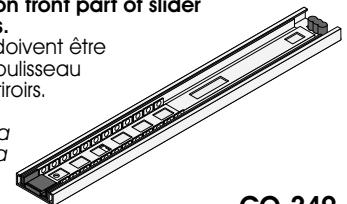

CO-249

# ▶ IMPORTANT NOTICE / AVIS IMPORTANT / NOTA IMPORTANTE

Please complete self-adhesive sticker. / Assurez-vous de bien remplir l'autocollant. / Asegúrese de completar correctamente la etiqueta.

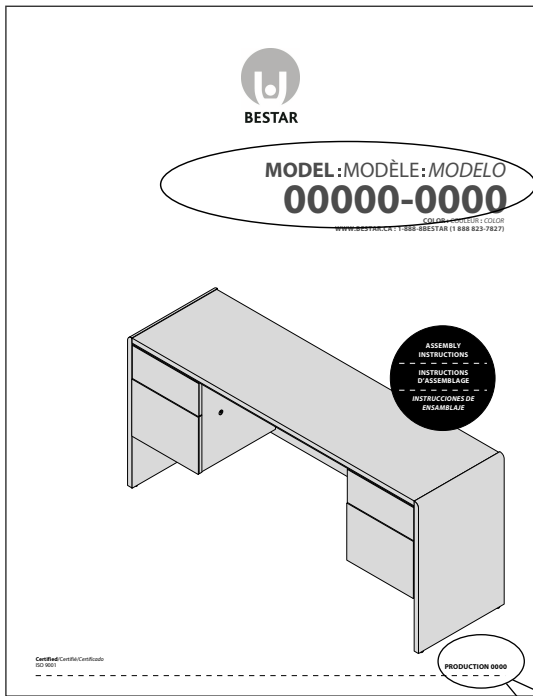

MODEL:MODELE:MODELO  
**00000-0000**

COLLECTION:MODERN COLOR  
WWW.BESTAR.COM 1-888-8BESTAR (1-888-823-7827)



PRODUCTION 0000

**PRODUCTION 0000**



**To better serve you!**  
Pour mieux vous servir!

**BESTAR**

→ **Model / Modèle:** \_\_\_\_\_

→ **Production Number**  
Numéro de production: \_\_\_\_\_

**Customer Service**  
Service à la clientèle **1-888-823-7827**

**For future reference and to better serve you, please apply the self-adhesive sticker in an accessible space such as inside a drawer.**

Pour mieux vous servir en cas de besoin, veuillez apposer l'autocollant dans un endroit facilement accessible tel que l'intérieur d'un tiroir.

*Para uno mejor servicio en caso de necesidad, poner la etiqueta en uno lugar de fácil acceso como por ejemplo al interior de un cajón.*

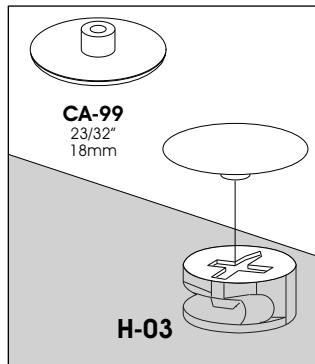

**When you have completed the assembly of your new furniture, install plastic caps**

Lorsque vous avez complété l'assemblage de votre meuble, installez les capuchons de plastique  
*Una vez que haya completado el ensamblaje del mueble, coloque los capuchones de plástico*

## PRODUCT CARE / ENTRETIEN DU PRODUIT / MANTENIMIENTO DEL PRODUCTO

**Avoid placing the furniture in the sunlight or near a source of heat. Use a soft dry cloth for dusting. To clean heavy dirt, use a cloth dipped in a solution of mild detergent and water. Avoid leaving wet objects on the surface or using commercial chemical cleaning products.**

Évitez d'exposer le meuble au soleil ou près de toute source de chaleur. Pour le nettoyage, utilisez un chiffon doux et sec. Pour la grosse saleté, utilisez un chiffon humidifié avec un peu de détergent dilué dans l'eau. Évitez de laisser des objets mouillés sur la surface de votre meuble ou d'utiliser des nettoyeurs chimiques.

*Evite exponer el mueble al sol o las fuentes de calor. Para limpiarlo, utilice un paño suave y seco. Para limpiar las manchas rebeldes, utilice un trapo húmedo con un poco de detergente diluido en agua. No deje objetos mojados encima del mueble ni utilice limpiadores que contengan productos químicos.*

**CONGRATULATIONS! YOU ARE NOW THE OWNER OF A QUALITY PRODUCT**  
FÉLICITATIONS! VOUS AVEZ MAINTENANT EN VOTRE POSSESSION UN PRODUIT DE QUALITÉ  
FELICITACIONES! AHORA ES USTED DUEÑO DE UN PRODUCTO DE CALIDAD.

**SERVICE/SERVICIO: 1-888 8BESTAR (1-888 823-7827)**

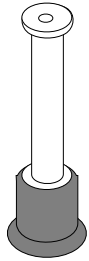

**You are at a step of hardware installation and some H-36 are missing: Before calling to order your missing bolts (H-36), please make sure you have not installed any bolts (H-36) in the wrong place. To remove a bolt (H-36) which is not in the correct place, please refer to your instruction manual.**

Vous êtes à une étape d'installation de quincaillerie et il vous manque des H-36 : Avant d'appeler pour commander des boulons (H-36), assurez-vous de ne pas avoir installé des boulons (H-36) au mauvais endroit. Pour enlever un boulon (H-36) mal situé, consultez le feuillet d'instructions.

*Usted está en alguna etapa de la instalación de quincallas y le faltan las H-36 : Antes de llamar para pedir los pernos (H-36), asegúrese de que no los haya instalado en el lugar equivocado. Para retirar un perno (H-36) mal puesto, consulte el folleto de instrucciones.*

**How to separate and install your CO-249 and CO-684 slides:**

**The CO-249 & CO-684 slides consist of two sections which you must separate. To separate the slides, please refer to your instruction manual. The slides are installed on distinct parts which will be re-grouped only when the drawers are installed on the furniture.**

Comment séparer et installer les coulisseaux CO-249 et CO-684 : Les coulisseaux CO-249 et CO-684 sont constitués d'une partie que vous devez séparer en deux sections. Pour séparer le coulisseau, référez-vous au feuillet d'instructions. Les coulisseaux sont installés sur deux pièces distinctes et seront regroupés seulement lors de l'installation des tiroirs dans le meuble.

*Cómo separar y instalar las guías correderas CO-249 y CO-684 : Las guías correderas CO-249 y CO-684 están constituidas por una parte que usted debe separar en dos secciones. Para separar las guías correderas, consulte el folleto de instrucciones. Las guías correderas se instalan en dos piezas distintas y sólo serán reagrupadas una vez que se instalen los cajones en el mueble.*

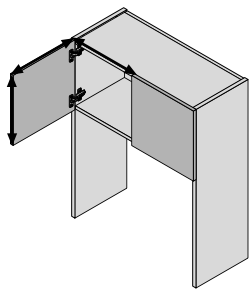
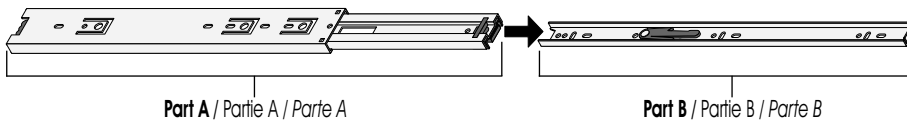

**The doors on your furniture are crooked or the space between the doors is uneven:**

**It is very important to install the hinges and hinge plates on the correct parts while respecting the instruction manual. For the installation and adjustment of the doors, please refer to your instruction manual or log on to the BESTAR internet site ([www.bestar.ca](http://www.bestar.ca)).**

Les portes de votre meuble sont croches ou l'espace qui les sépare est inégal : Il est important d'installer les pentures et les plaques sur les bonnes pièces en respectant le feuillet d'instructions. Pour l'installation des portes et leur ajustement, référez-vous à l'étape d'installation des portes dans le feuillet d'instructions ou sur le site internet de BESTAR ([www.bestar.ca](http://www.bestar.ca)).

*Las puertas de su mueble están chuecas o el espacio que las separa es desigual : Es importante instalar las bisagras y las placas sobre las piezas adecuadas respetando el folleto de instrucciones. Para la instalación de las puertas y su ajuste, consulte la etapa de instalación de las puertas en el folleto de instrucciones o en el sitio Internet de BESTAR ([www.bestar.ca](http://www.bestar.ca)).*

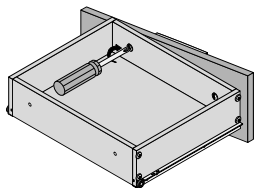

**The drawers on your furniture are crooked or the space between the drawers is uneven:**

**While referring to the section indicating the actual sizes of the screws in your instruction manual, please insure that you are using the correct size screws needed when installing your drawer slides and drawer fronts. They must be installed straight. While installing the drawer front, make sure that the correct side is facing up. For the adjustment of the drawer fronts, please refer to your instruction manual or log on to the BESTAR internet site ([www.bestar.ca](http://www.bestar.ca)).**

Les tiroirs de votre meuble sont croches ou l'espace qui les sépare est inégal : En vous référant au tableau de vis grandeur réelle du feuillet d'instructions, assurez-vous que vous avez utilisé les bonnes vis lors de l'installation des coulisseaux ainsi que du devant de tiroir et qu'elles sont posées bien droites. Assurez-vous également que le devant du tiroir n'est pas assemblé à l'envers. Référez-vous à l'étape d'ajustement des tiroirs dans le feuillet d'instructions ou sur le site internet de BESTAR ([www.bestar.ca](http://www.bestar.ca)).

*Los cajones de su mueble están chuecos o el espacio que los separa es desigual : Consulte la tabla de tornillos en tamaño real del folleto de instrucciones y asegúrese de que haya utilizado los tornillos adecuados durante la instalación de las guías correderas así como también la parte delantera del cajón y que éstos estén puestos bien derechos. Asegúrese también de que la parte delantera del cajón no esté ensamblada al revés. Consulte la etapa del ajuste de cajones en el folleto de instrucciones o en el sitio Internet de BESTAR ([www.bestar.ca](http://www.bestar.ca)).*



## For more information or to discover our new products

Pour toute information ou pour découvrir nos nouveaux produits  
*Para obtener más información o para obtener nuevos productos*

[www.bestar.ca/site/en/register\\_your\\_product](http://www.bestar.ca/site/en/register_your_product)

[www.bestar.ca/site/fr/enregistrement\\_de\\_produit](http://www.bestar.ca/site/fr/enregistrement_de_produit)



**FOR LONG TIME**  
**POUR LONGTEMPS**  
*POR MUCHO TIEMPO*



## OUR FURNITURE IS GARANTEED FOR 10 YEARS. NO MATTER THE PROBLEM, OUR CUSTOMER SERVICE IS THERE FOR YOU.

NOS MEUBLES SONT GARANTIS POUR 10 ANS. PEU IMPORTE LE PROBLÈME, N'HÉSITÉZ PAS À COMMUNIQUER AVEC NOTRE SERVICE À LA CLIENTÈLE.

*NUESTROS MUEBLES TIENEN UNA GARANTIA DE 10 AÑOS. NO IMPORTA EL PROBLEMA, COMUNIQUE CON NUESTRO SERVICIO A CLIENTE.*



**BESTAR**

**The new logo shows an open and radiant person. It also evokes the past of BESTAR, the fact that we were the first manufacturer of ready-to-assemble furniture to design U-Shape furniture. Finally, if you take the logo in its simplest form, it shows that BESTAR is there for its employees, for its customers and for its consumers, "BESTAR is there for you (U)".**

Le nouveau logo illustre un personnage ouvert et rayonnant. Il évoque également le passé de BESTAR qui fut le premier fabricant de meubles prêt-à-assembler à concevoir des bureaux en forme de «U». Finalement, si on prend le logo sous sa forme la plus simple, il rappelle que BESTAR est présent pour ses employés, ses clients et ses consommateurs.

*El logotipo ilustra un personaje abierto y radiante. Evoca igualmente, el pasado porque Bestar fue el primer fabricante de muebles listos para ensamblar a concebir escritorios en forma de "U". Finalmente, si tomamos el logotipo con su forma la más sencilla, nos recuerda que Bestar está presente para sus empleados, para sus clientes y para sus consumidores. "BESTAR está aquí para USTED (U)".*