



BESTAR

MODEL:MODÈLE:MODELO
92420-2163-2263

TUSCANY BROWN & BLACK : BRUN TOSCANE ET NOIR : PARDO TOSCANA Y NEGRO
WWW.BESTAR.CA : 1-888-8BESTAR (1 888 823-7827)

92420-2168-2268

CAPPUCCINO CHERRY : CERISIER CAPPUCCINO : CEREZO CAPPUCCINO
WWW.BESTAR.CA : 1-888-8BESTAR (1 888 823-7827)

LEFT ASSEMBLY
INSTRUCTIONS

INSTRUCTIONS
D'ASSEMBLAGE GAUCHE

INSTRUCCIONES DE
ENSAMBLAJE IZQUIERDO

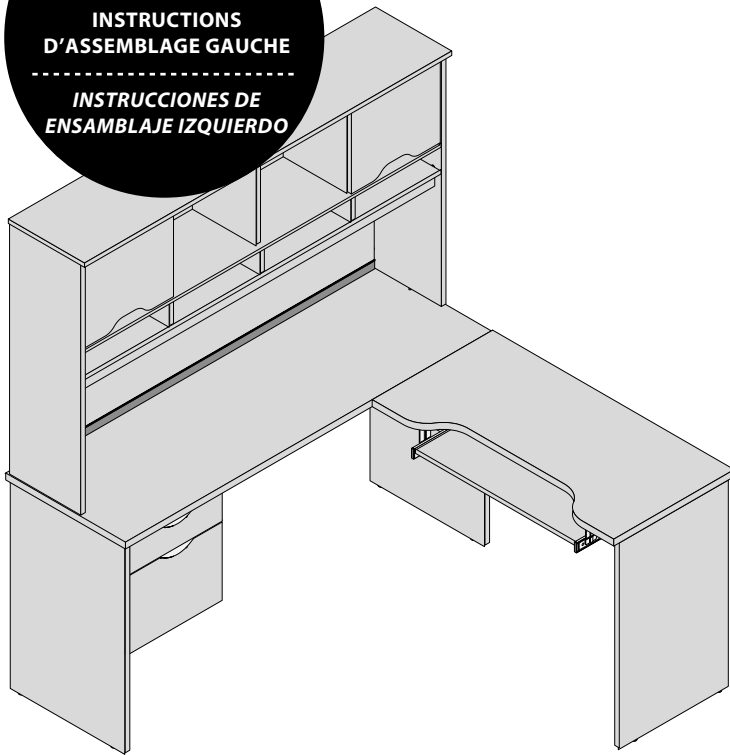

RIGHT ASSEMBLY
INSTRUCTIONS

INSTRUCTIONS
D'ASSEMBLAGE DROIT

INSTRUCCIONES DE
ENSAMBLAJE DERECHO

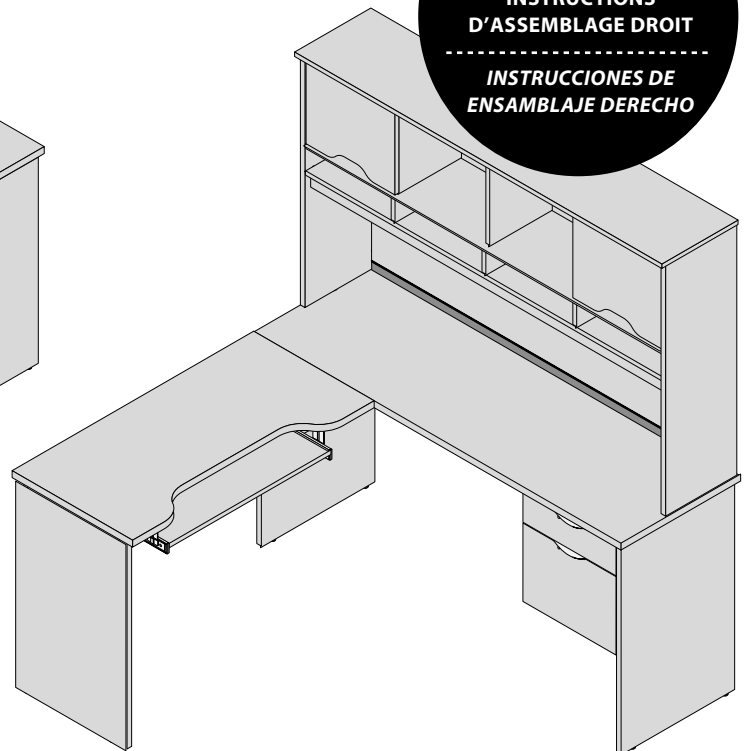

Thank you for choosing a BESTAR product. Your total satisfaction is our #1 priority.

Customer service and warranty information

Should you have a problem or need more information concerning the warranty, **do not call to the place of purchase.**

Please call our customer service department for immediate assistance using the following toll free number:

Monday to Thursday: 8H00 AM to Noon and 1H00 PM to 5H00 PM E.S.T / Friday: 8H00 AM to Noon and 1H00 PM to 4H00 PM E.S.T

Please have your assembly instruction manual on hand when you call. BESTAR products are warranted to the original purchaser against defects in material or workmanship in the furniture. Defects as mentioned in this warranty refer to any imperfections which may impair the use of the product. Our warranty is expressly limited to the replacement of furniture parts and components for ten years following the date of purchase. BESTAR will replace any part that is defective. This warranty applies under conditions of normal use. Our furniture products are not intended for outdoor use. The warranty does not cover defects caused by improper assembly or disassembly, defects occurring after purchase due to product modifications, intentional damage, accident, misuse, exposure to the elements and labor or assembly costs. Bestar reserves the right to request proof of purchase to document a warranty claim. In no event shall BESTAR be liable for incidental or consequent damages resulting from the misuse of the product. This warranty is not transferable and is valid only in Canada and the United States excluding Alaska, Hawaii and Puerto Rico.



www.bestar.ca

1 888 823-7827

Merci d'avoir choisi les produits BESTAR. Vous satisfaire est notre priorité.

Service à la clientèle et informations relatives à la garantie

Si vous rencontrez un problème ou si vous souhaitez de plus amples informations concernant votre garantie, **ne vous adressez pas au magasin où vous avez effectué votre achat. Pour obtenir une aide immédiate, veuillez appeler notre service après-vente au numéro sans frais :**

Lundi au jeudi : 8H00 à 12H00 et 13H00 à 17H00 HNE / Vendredi : 8H00 à 12H00 et 13H00 à 16H00 HNE

Veillez avoir en main le manuel d'instructions lors de votre appel. La garantie des produits BESTAR est valide, pour l'acheteur original, en cas de défaut de matériel ou de fabrication. Les défauts couverts par cette garantie incluent toutes les imperfections qui ont pour conséquence une utilisation non appropriée du produit. Notre garantie est expressément limitée au remplacement des composants et des éléments de meubles pour une durée de dix ans suivant la date de l'achat. BESTAR s'engage à remplacer tout élément défectueux. Cette garantie s'inscrit dans le cadre d'une utilisation du produit dans des conditions normales. Nos meubles ne sont pas destinés à être utilisés à l'extérieur. La garantie ne couvre pas les défauts générés par un assemblage ou un démontage non conforme, les défauts apparus suite à des modifications apportées au produit, à des dommages intentionnels, à un accident, une mauvaise utilisation, l'utilisation à l'extérieur, ni les coûts de main d'œuvre ou d'assemblage. Bestar se réserve le droit d'exiger une preuve d'achat afin de documenter la réclamation. La société BESTAR ne pourra être tenue, en aucun cas, responsable de dommages indirects ou consécutifs, suite à une mauvaise utilisation du produit. Cette garantie ne peut être transférée et est valide au Canada et aux États-Unis sauf Hawaï, Puerto Rico et Alaska.

Gracias por elegir un producto BESTAR. Su entera satisfacción es nuestra prioridad N°1.

Servicio de atención al cliente e información sobre la garantía

Si tiene algún problema y necesita más información sobre la garantía, no vaya al lugar donde realizó la compra. **Llame a nuestro departamento de atención al cliente para recibir ayuda inmediata utilizando nuestro servicio de llamada gratuita :**

De lunes a jueves : de 8H00 AM a Mediodía y de 1H00 PM a 5H00 PM EST / Viernes : de 8h00 AM a Mediodía y de 1H00 PM a 4H00 PM EST







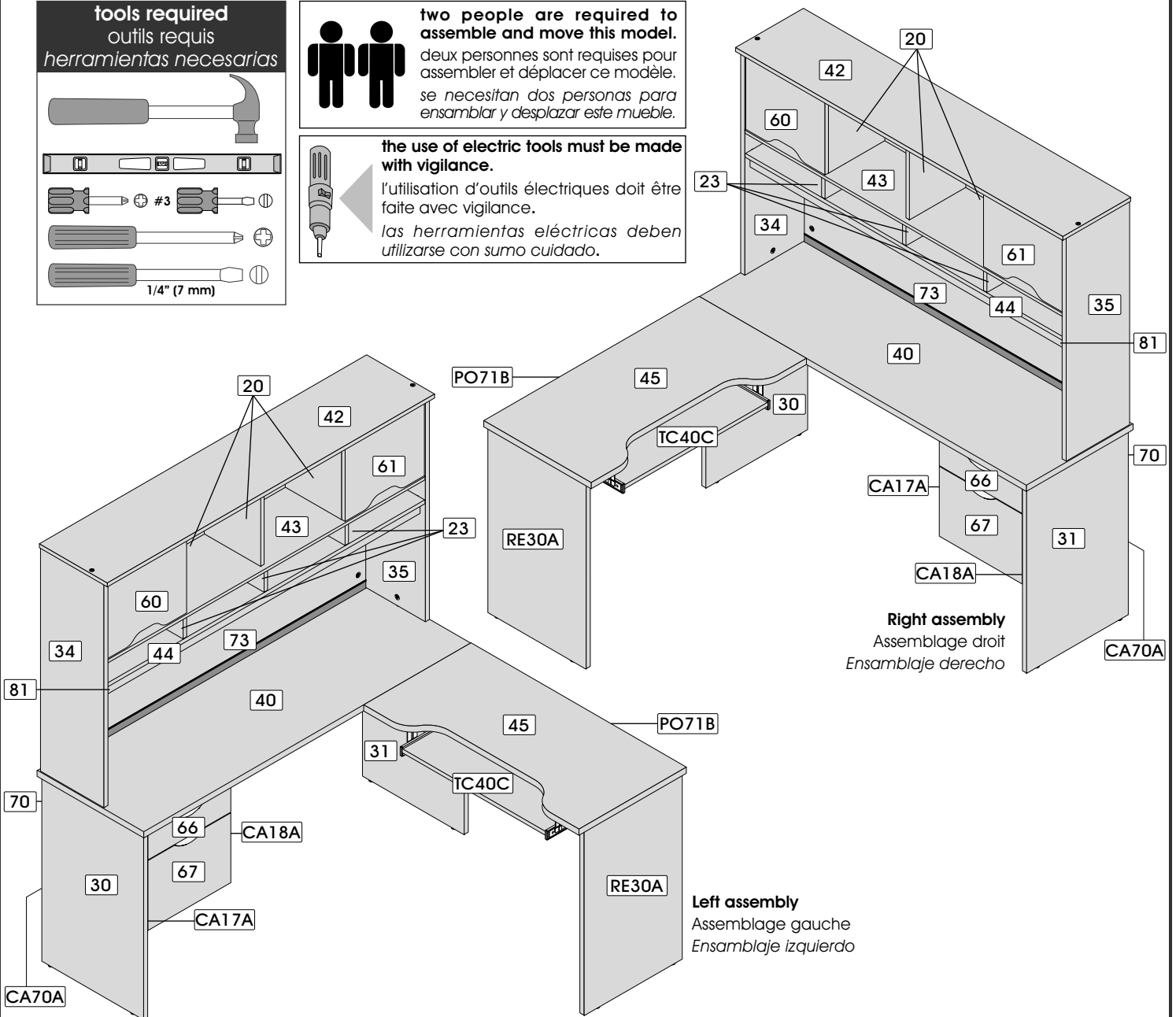
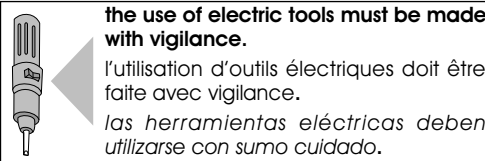
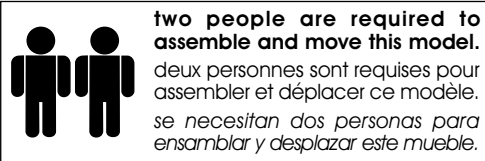
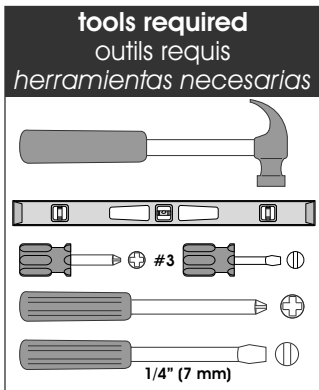







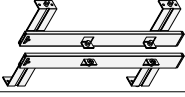









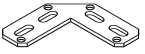
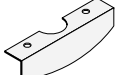

Cuando llame, tenga a mano su manual de instrucciones de montaje. Los productos BESTAR están garantizados por el comprador original contra defectos en el material o en la confección del mueble. Los defectos, tal como se describen en esta garantía incluyen toda imperfección que pueda impedir el uso del producto. Nuestra garantía se limita expresamente al reemplazo de las partes y componentes del mueble defectuosos por diez años a partir de la fecha de compra. BESTAR reemplazará cualquier pieza defectuosa. Esta garantía se aplica según las condiciones de uso normal. Nuestros productos no están diseñados para ser utilizados al aire libre. La garantía no cubre defectos provocados por ensamble o desensamble incorrectos, defectos ocurridos luego de la compra por la modificación del mueble, daños intencionales, accidentes, uso incorrecto, exposición a los agentes naturales ni costos derivados de la fabricación o ensamblaje. Bestar se reserva el derecho de solicitar una factura de compra para poder extender un reclamo de garantía. Bajo ninguna circunstancia BESTAR será responsable de los daños accidentales o consecuentes que pudieran resultar del uso incorrecto del producto. Esta garantía es intransferible y se aplica solamente a Canadá y los Estados Unidos.

PARTS / PIÈCES / PIEZAS



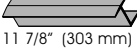

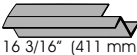
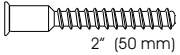
CODE / CÓDIGO	QTY / QTÉ / CANT.	CODE / CÓDIGO	QTY / QTÉ / CANT.	CODE / CÓDIGO	QTY / QTÉ / CANT.	CODE / CÓDIGO	QTY / QTÉ / CANT.
CA03A	2	30	1	43	1	CA70A	1
CA05A	2	RE30A	1	44	1	PO71B	1
CA09A	2	31	1	45	1	73	1
CA13A	2	34	1	60	1	81	1
CA17A	1	35	1	61	1	bottom / fond / fondo 15 3/8" x 12 1/2" (391 mm x 316 mm)	2
CA18A	1	40	1	66	1	back panel / dos / panel trasero 58 3/8" x 13 1/4" (1482 mm x 337 mm)	1
20	3	TC40C	1	67	1		
23	3	42	1	70	1		

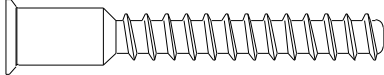

HARDWARES / QUINCAILLERIES / QUINCALLAS

CODE / CÓDIGO	QTY / QTÉ / CANT.	CODE / CÓDIGO	QTY / QTÉ / CANT.	CODE / CÓDIGO	QTY / QTÉ / CANT.	CODE / CÓDIGO	QTY / QTÉ / CANT.
AM-182  1/16" (2 mm)	6	CO-762 runners 400 mm (15 3/4") coulisseaux 400 mm correderas 400 mm	1	H-03 	52	VM-601  3/4" (20 mm)	4
CA-77 	1	CO-843 	1	H-04 	6	VP-218  1/2" (13 mm)	6
CA-99 	39	CR-141 	2	H-36 	42	VR-207  1/2" (13 mm)	26
CA-100 	5	EC-744 	4	PA-844 	6	VR-210  5/8" (16 mm)	8
CA-103 	4	EQ-143 	2	PO-842 	2	VR-212  1" (25 mm)	19
CH-840 	4	EQ-314 	6	SE-686 	1		
CL-140 	-	EX-681  11 7/8" (303 mm)	2	TI-552 	1		
CL-745 	1	EX-702  16 3/16" (411 mm)	2	VC-204  2" (50 mm)	8		
CO-249 runners 406 mm (16") coulisseaux 406 mm correderas 406 mm	1	EX-766 	1	VE-244  3/8" (10 mm)	10		

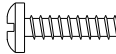
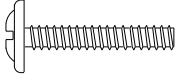
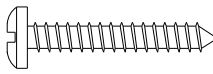
REAL SIZE / GRANDEUR RÉELLE / TAMAÑO REAL

CODE / CÓDIGO	QTY / QTÉ / CANT.	CODE / CÓDIGO	QTY / QTÉ / CANT.
VC-204  2" (50 mm)	8	VR-207  1/2" (13 mm)	26
VE-244  3/8" (10 mm)	10	VR-210  5/8" (16 mm)	8
VM-601  3/4" (20 mm)	4	VR-212  1" (25 mm)	19
VP-218  1/2" (13 mm)	6		

IMPORTANT NOTICE / NOTE IMPORTANTE / NOTA IMPORTANTE

Group together all the hardware required for each step as the construction of your piece of furniture is progressing.
 Regroupez toutes les quincailleries requises pour chaque étape de façon à vous assurer de tout installer au bon moment.
 Reúna todas las quincallas necesarias para cada una de las etapas de montaje, para asegurar una correcta instalación en el momento adecuado.

▶ IMPORTANT NOTICE / NOTE IMPORTANTE / NOTA IMPORTANTE

Duly complete the self-adhesive sticker. / Assurez-vous de bien remplir l'autocollant. / Asegúrese de completar correctamente la etiqueta.

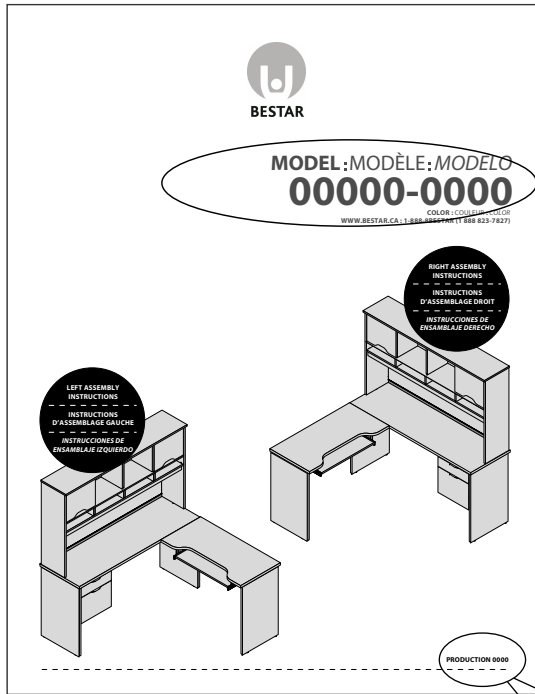

PRODUCTION 0000

BESTAR

To better serve you!
Pour mieux vous servir!

Model / Modèle: _____

Production Number
Numéro de production: _____

Customer Service
Service à la clientèle **1-888-823-7827**

Important/Importante

Please retain the self-adhesive sticker which you will install at step 19 of the instruction manual.

Conservez l'autocollant qui sera collé seulement à l'étape 19 du feuillet d'instructions.

Conserve la etiqueta que será pegada sólo en la etapa 19 de la hoja de instrucciones.

▶ IMPORTANT NOTICE / NOTE IMPORTANTE / NOTA IMPORTANTE

▶ Main hardware system / Système de quincaillerie principal / Sistema principal de quincalla

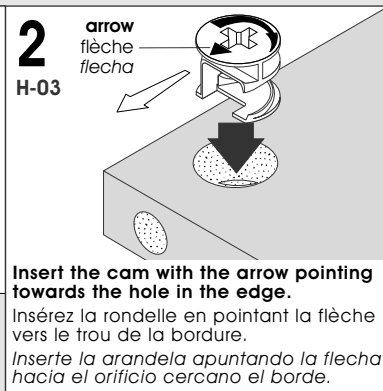
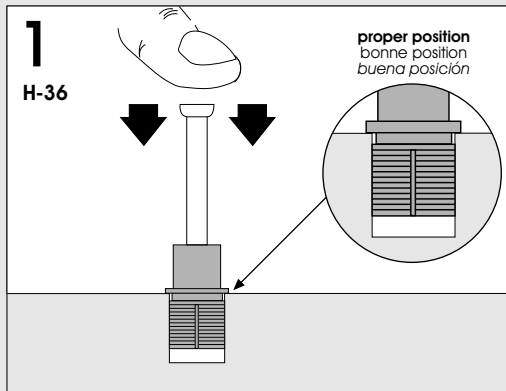

If needed / En cas de nécessité / En caso de necesidad

How to remove a misplaced assembly bolt (H-36).
Comment retirer un boulon (H-36) mal situé.
Cómo retirar un perno (H-36) mal ubicado.

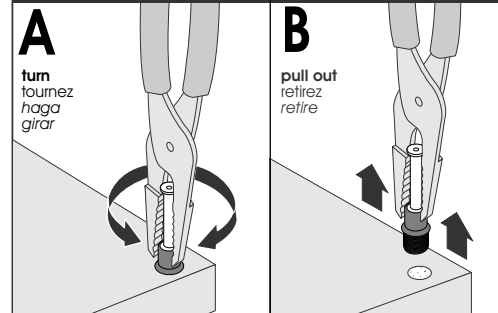

SERVICE/SERVICIO: 1-888 8BESTAR (1-888 823-7827)

Desk / Bureau / Escritorio

Right assembly

p.6 to p.15

Assemblage droit
p.6 à p.15

Ensamblaje derecho
p.6 a p.15

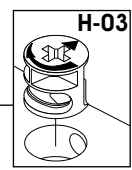
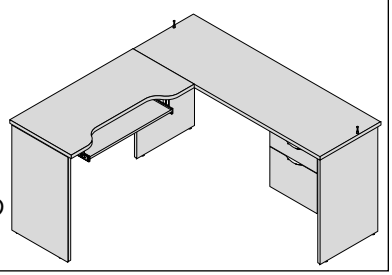

Important
Importante

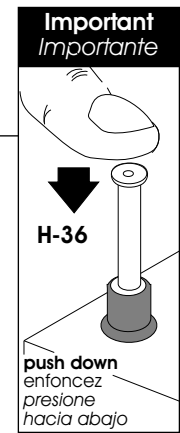
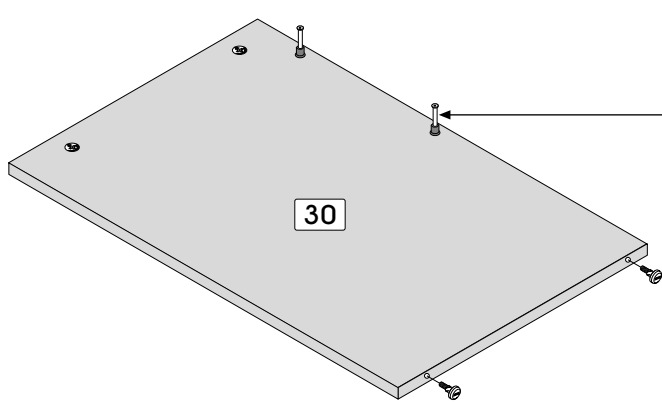
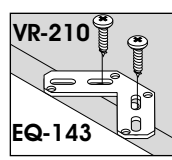
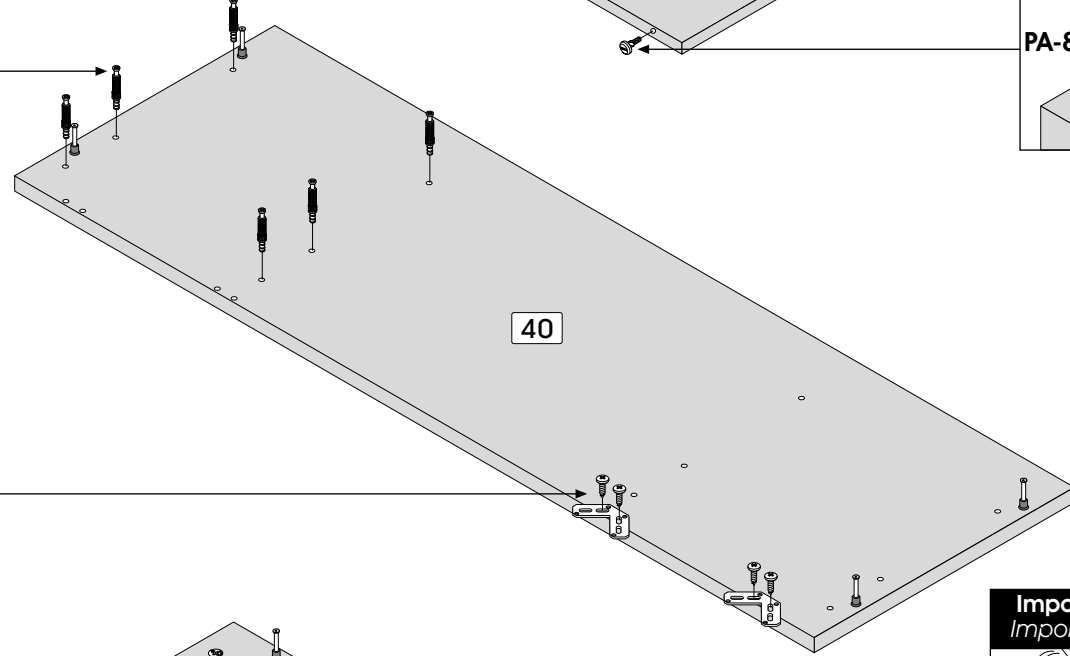
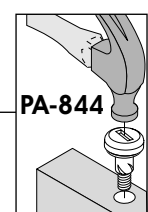
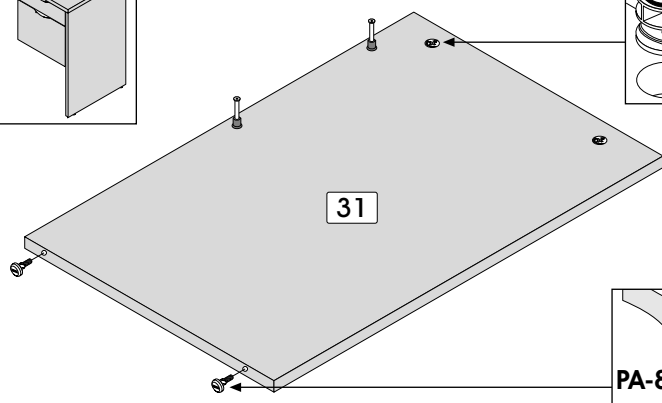
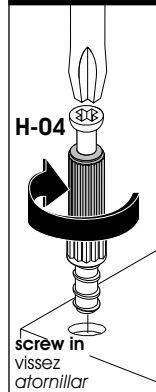

Code / Código

Qty / Qté / Cant.

H-03	H-36	H-04	PA-844	EQ-143	VR-210
x 4	x 8	x 6	x 4	x 2	x 4

2 HARDWARE INSTALLATION / INSTALLATION DES QUINCAILLERIES / INSTALACIÓN DE LAS QUINCALLAS

Desk / Bureau / Escritorio

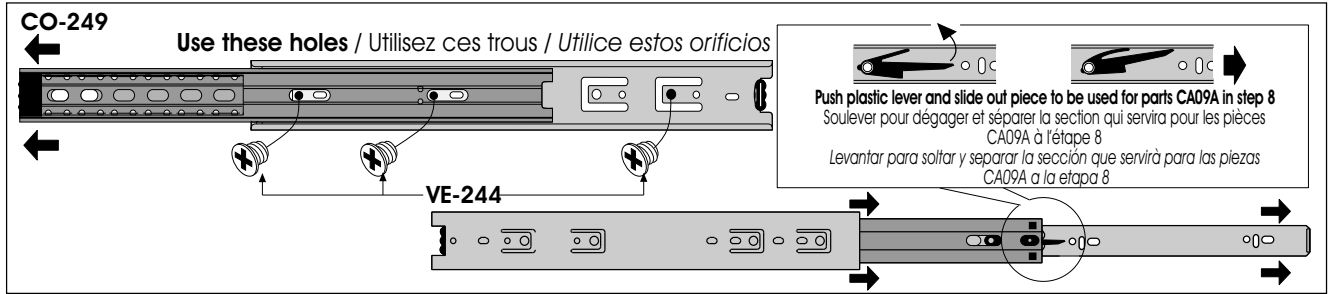

Important
Importante

VE-244
CO-762

Make sure to use the largest in runner holes (CO-762), as indicated below.
Assurez-vous d'utiliser les plus gros trous du coulisseau (CO-762), tel qu'indiqué ci-dessous.
Utilice los agujeros más grandes de la guía (CO-762), como se indica a continuación.

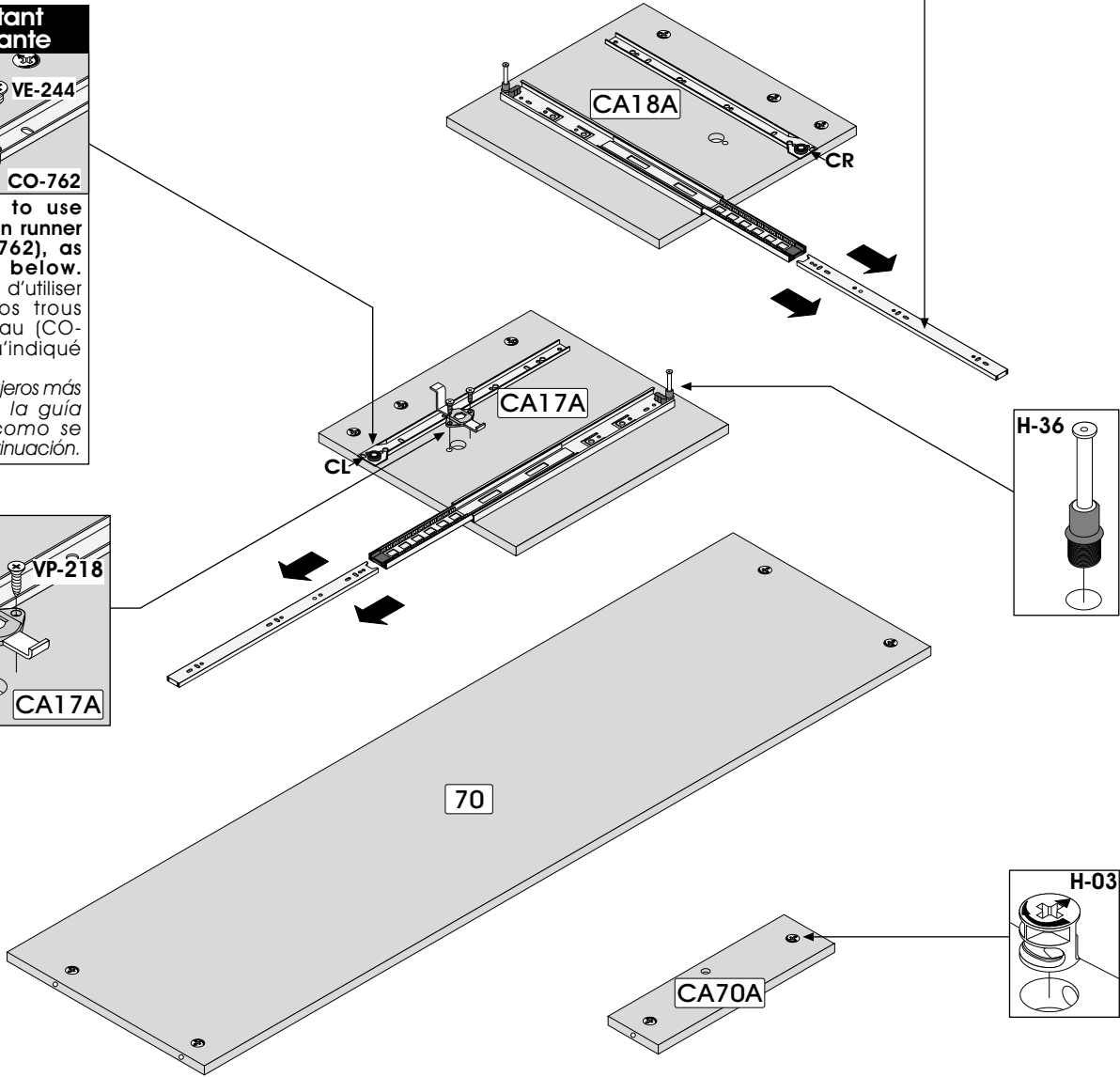
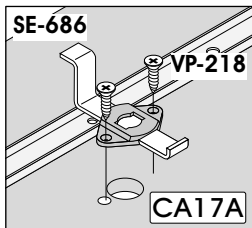

2

Code / Código	CO-249	CO-762	H-03	H-36	SE-686	VE-244	VP-218
Qty / Qté / Cant.	x 1	x 1	x 12	x 2	x 1	x 10	x 2

15 3/4" (400 mm)
screws / vis / tornillos

3/8" (10 mm)
1/2" (13 mm)

SERVICE/SERVICIO: 1-888 8BESTAR (1-888 823-7827)

IMPORTANT NOTICE / NOTE IMPORTANTE / NOTA IMPORTANTE

▶ Main hardware system / Système de quincaillerie principal / Sistema principal de quincalla

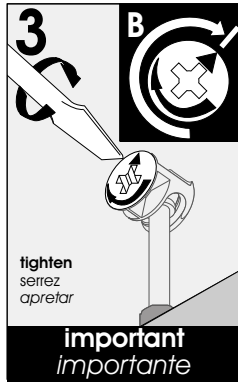
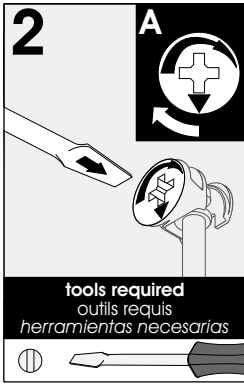
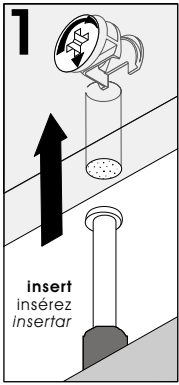

Make sure to properly tighten each cam to ensure furniture solidity. Otherwise, parts could be damaged or the user could be injured.

Assurez-vous de bien resserrer chaque rondelle pour assurer la solidité du meuble. Dans le cas contraire, des pièces pourraient être endommagées ou l'utilisateur pourrait se blesser.

Asegúrese de apretar bien cada arandela para garantizar la solidez del mueble. De lo contrario, podría provocarse daño a las piezas o las personas.

3 PRE-ASSEMBLY / PRÉ-ASSEMBLAGE / PREENSAMBLAJE

Desk / Bureau / Escritorio



two people are required to assemble and move this model.
deux personnes sont requises pour assembler et déplacer ce modèle.
se necesitan dos personas para ensamblar y desplazar este mueble.

Assemble on the back edge

Assemblez sur la bordure arrière
Realice el ensamblaje sobre el borde trasero

Assembling sequence

Séquence d'assemblage
Secuencia de ensamblaje

Parts / Pièces / Piezas:

70 30 31 40

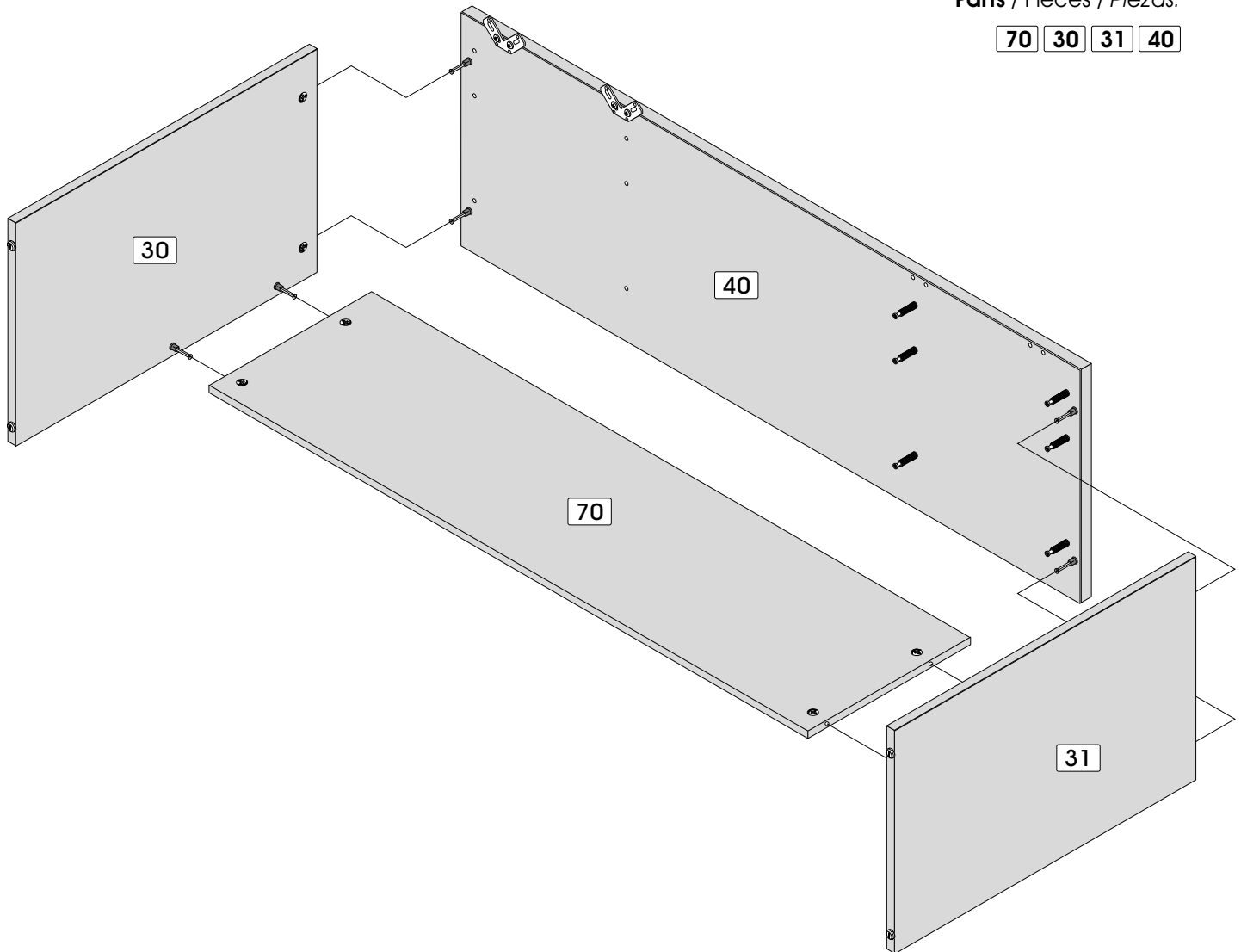

Desk / Bureau / Escritorio

Assemble on the back edge

Assemblez sur la bordure arrière

Realice el ensamblaje sobre el borde trasero

Assembling sequence

Séquence d'assemblage

Secuencia de ensamblaje

Parts / Pièces / Piezas:

CA18A CA70A CA17A + 40



two people are required to assemble and move this model.
 deux personnes sont requises pour assembler et déplacer ce modèle.
 se necesitan dos personas para ensamblar y desplazar este mueble.

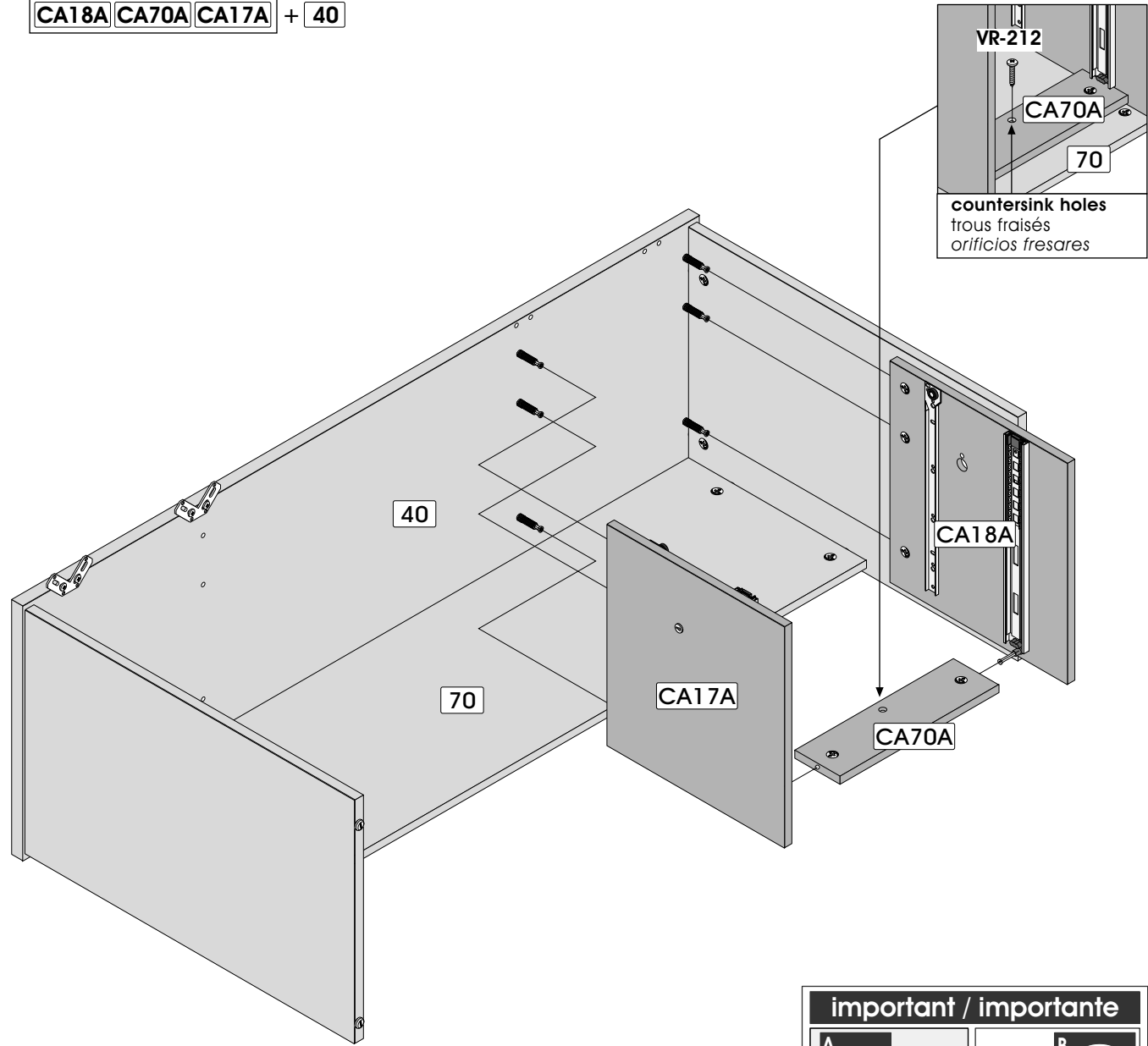

4



Code / Código VR-212
 Qty / Qté / Cant. x 1

important / importante

A

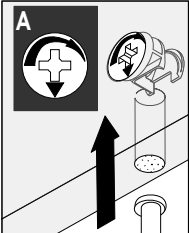

↑
insert
insérez
insertar

B

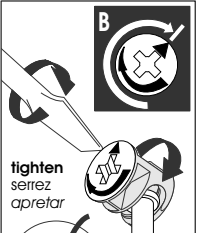

tighten
serrez
apretar

Desk / Bureau / Escritorio

important / importante

Drive the screw all the way in to install CO-843.

Vissez à fond avant d'installer la CO-843.

Atornille a fondo antes de instalar el CO-843.

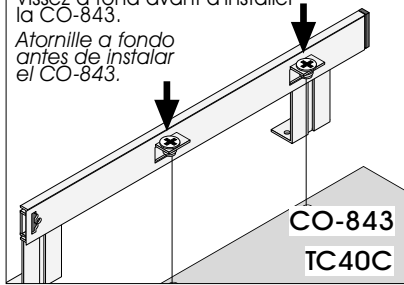

CO-843
TC40C

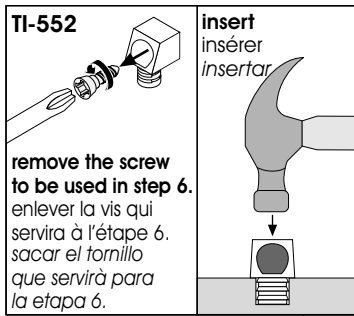
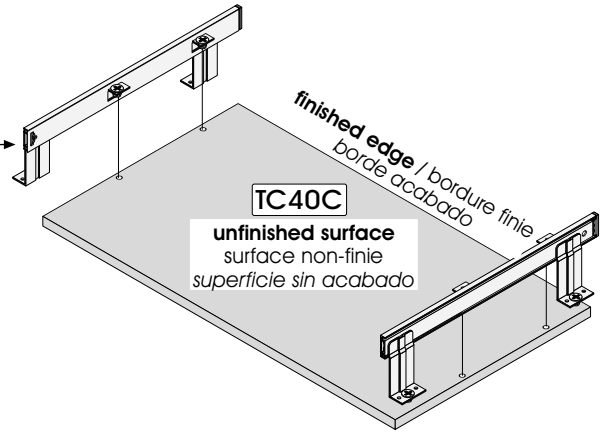

TI-552

insert
insérer
insertar

remove the screw to be used in step 6.
enlever la vis qui servira à l'étape 6.
sacar el tornillo que servirá para la etapa 6.

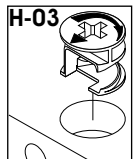

H-03

PO71B

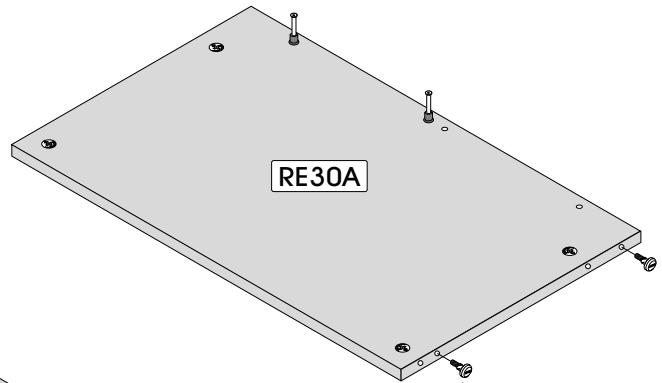

RE30A

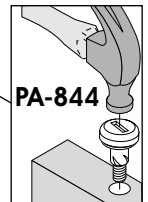

PA-844

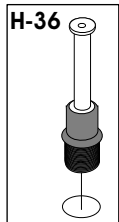

H-36

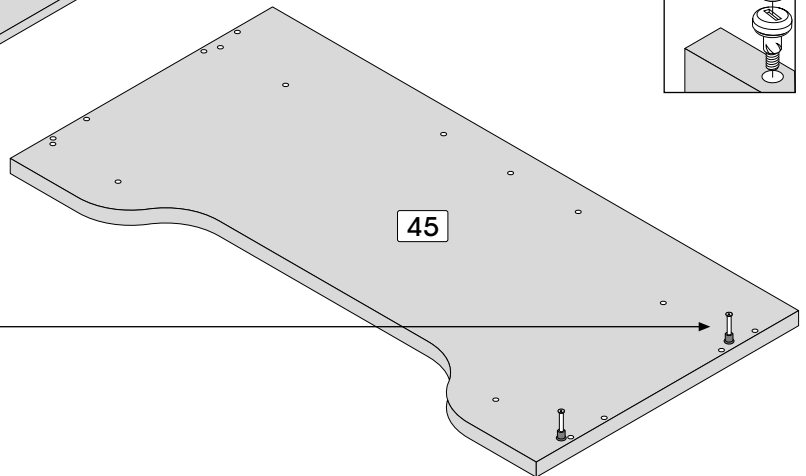

45

Code / Código

Qty / Qté / Cant.



H-03

x 8

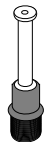

H-36

x 4



PA-844

x 2



TI-552

x 1

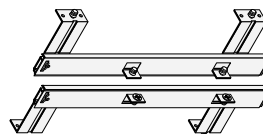

CO-843

x 1

Desk / Bureau / Escritorio

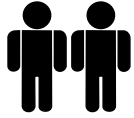

two people are required to assemble and move this model.

deux personnes sont requises pour assembler et déplacer ce modèle.
se necesitan dos personas para ensamblar y desplazar este mueble.

Assemble upside down

Assemblez en position renversée
Realice el ensamblaje en posición invertida

Assembling sequence

Séquence d'assemblage
Secuencia de ensamblaje

Parts / Pièces / Piezas:

45 RE30A PO71B TC40C

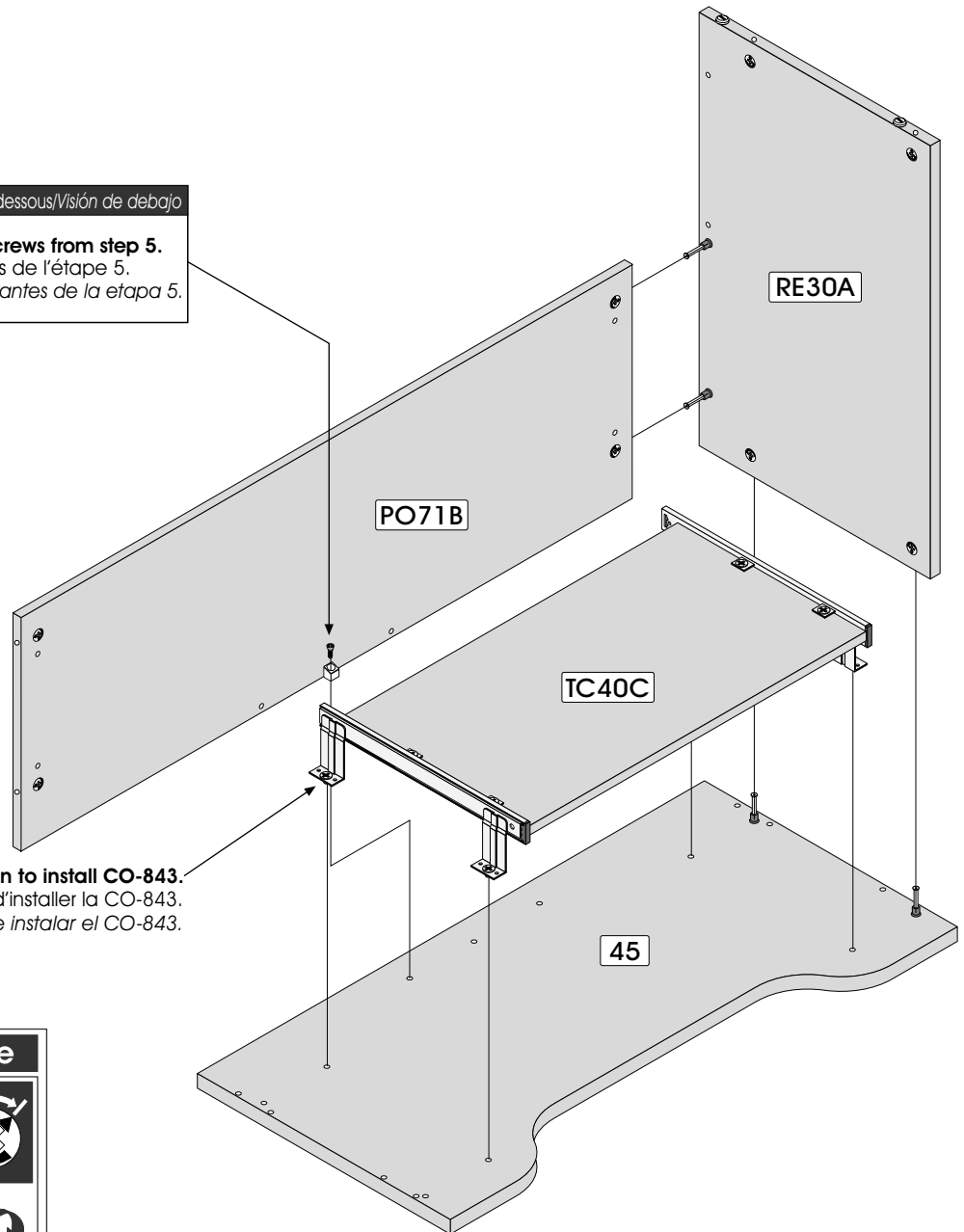
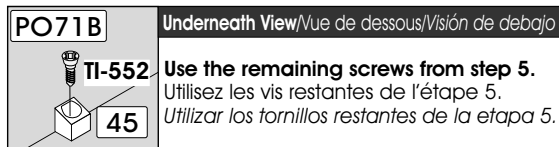

Drive the screws all the way in to install CO-843.

Vissez à fond avant d'installer la CO-843.
Atornille a fondo antes de instalar el CO-843.

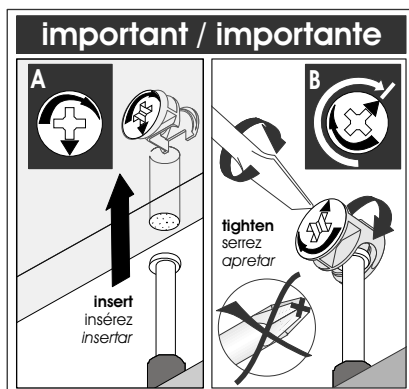

7 ASSEMBLY / ASSEMBLAGE / ENSAMBLAJE

Desk / Bureau / Escritorio

Assembling sequence
 Séquence d'assemblage
 Secuencia de ensamblaje
Parts / Pièces / Piezas:

30 40 + **45 PO71B**



two people are required to assemble and move this model.
 deux personnes sont requises pour assembler et déplacer ce modèle.
 se necesitan dos personas para ensamblar y desplazar este mueble.

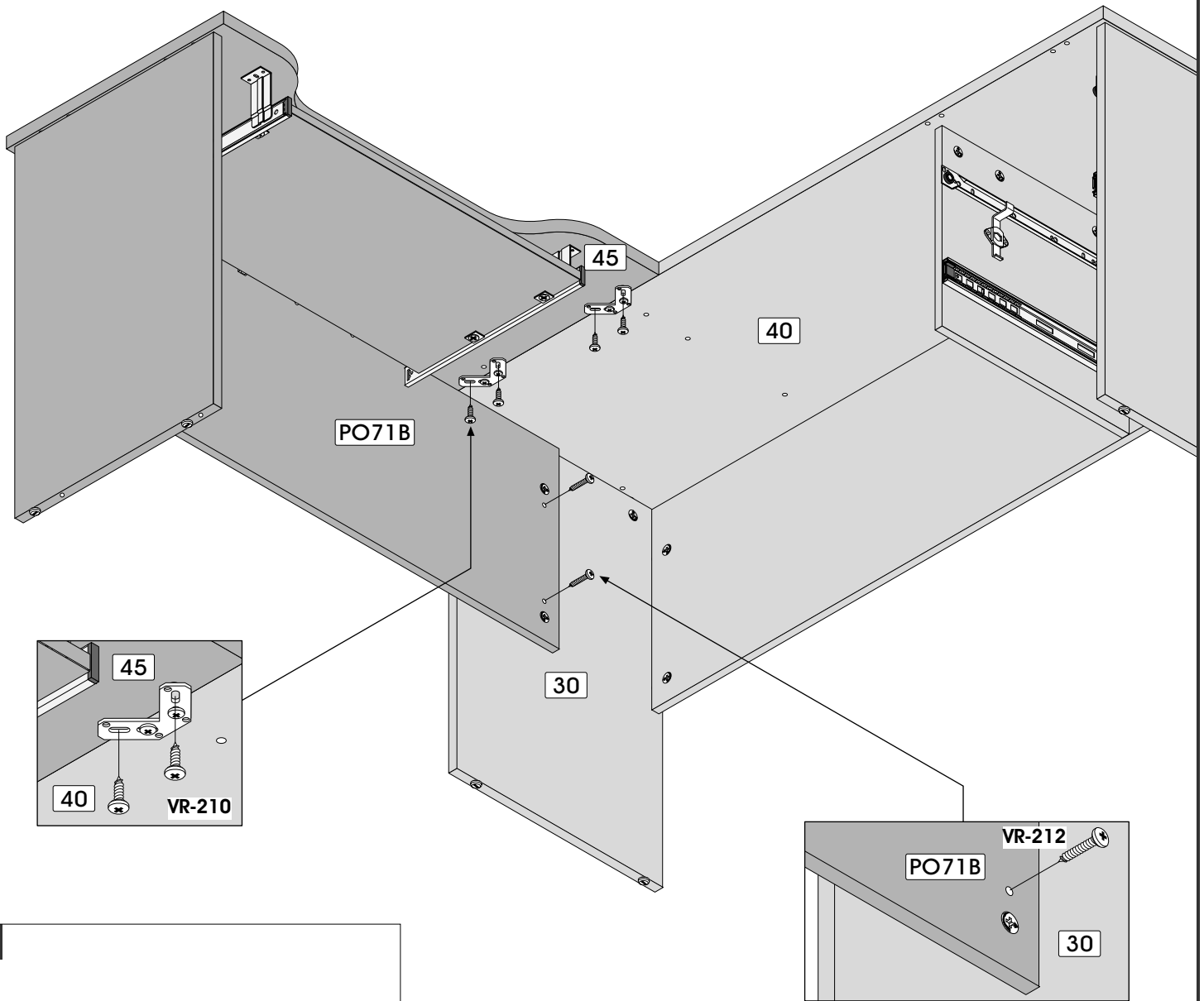

Code / Código	VR-210	VR-212
Qty / Qté / Cant.	x 4	x 2

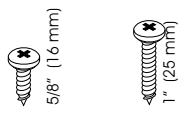

Drawers / Tiroirs / Cajónes

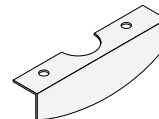
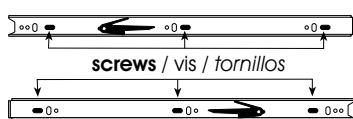
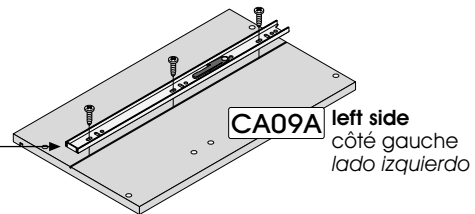
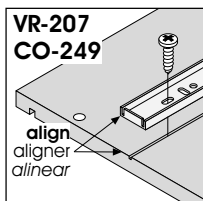
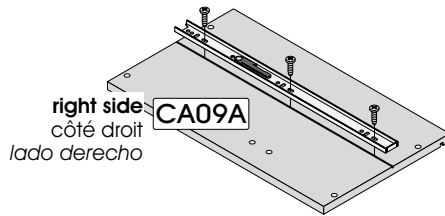
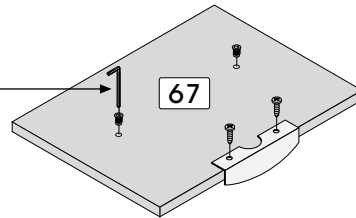
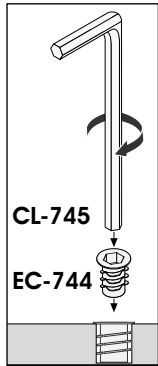

Code / Código

CO-249

EC-744

CL-745

PO-842

VR-207

Qty / Qté / Cant.

x 1

x 4

x 1

x 2

x 10

Assembling sequence
 Séquence d'assemblage
 Secuencia de ensamblaje
Parts / Pièces / Piezas:

CA05A CA03A CA03A + bottom / fond / fondo + CA05A 66

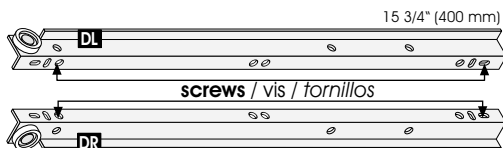
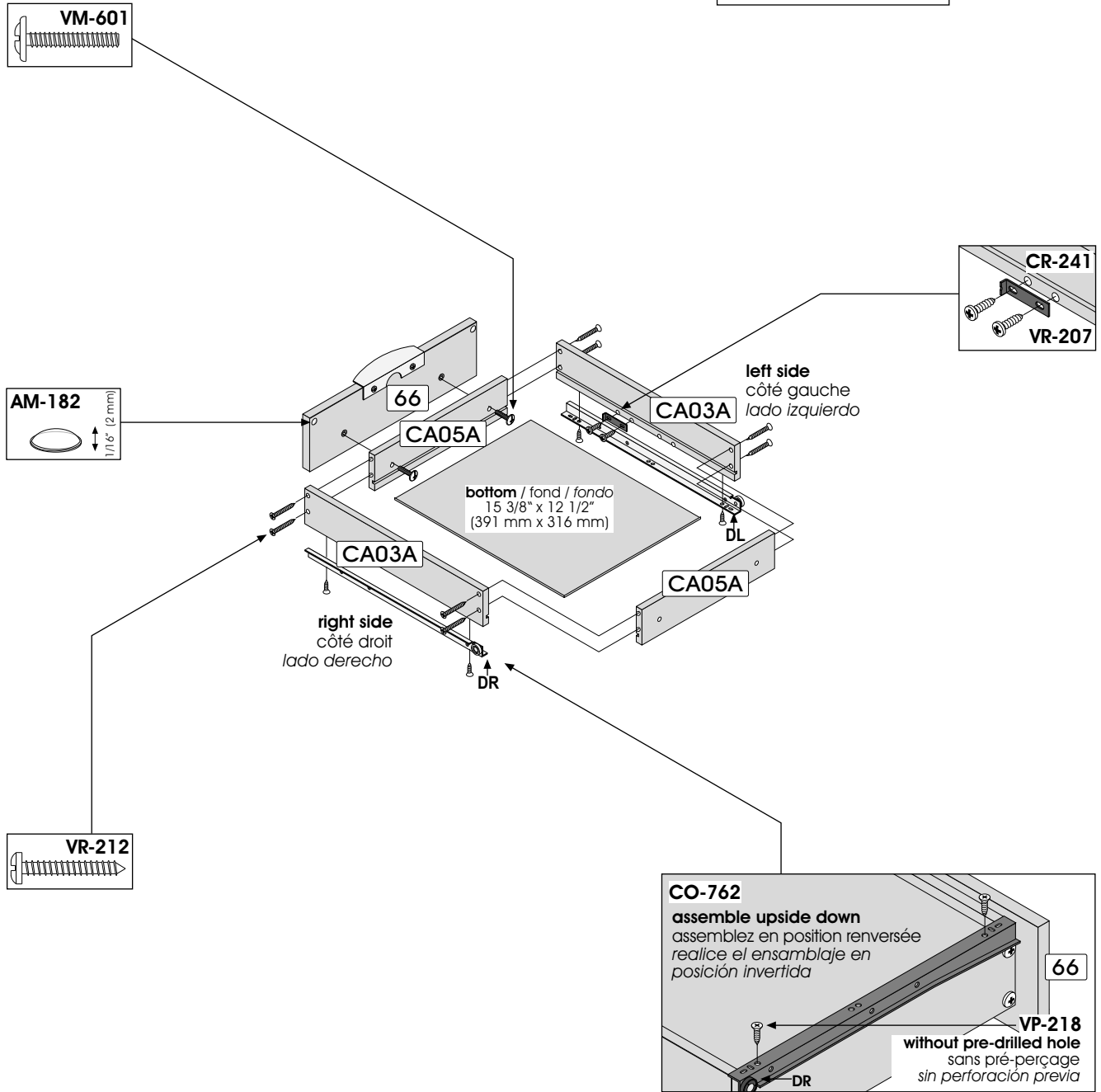

Code / Código CO-762

Qty / Qté / Cant. x 1

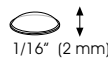

AM-182

x 2



CR-141

x 1



VP-218

x 4



VR-207

x 2



VM-601

x 2



VR-212

x 8

Drawer / Tiroir / Cajón

Assembling sequence

Séquence d'assemblage

Secuencia de ensamblaje

Parts / Pièces / Piezas:

CA13A EX-681 + CA09A EX-702 + CA09A EX-702 +
 bottom / fond / fondo + CA13A EX-681 + 67

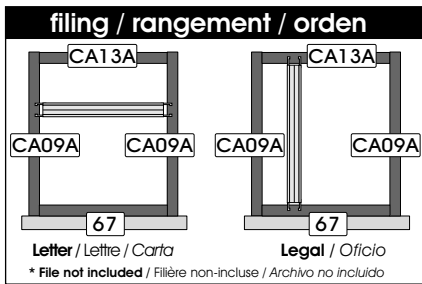
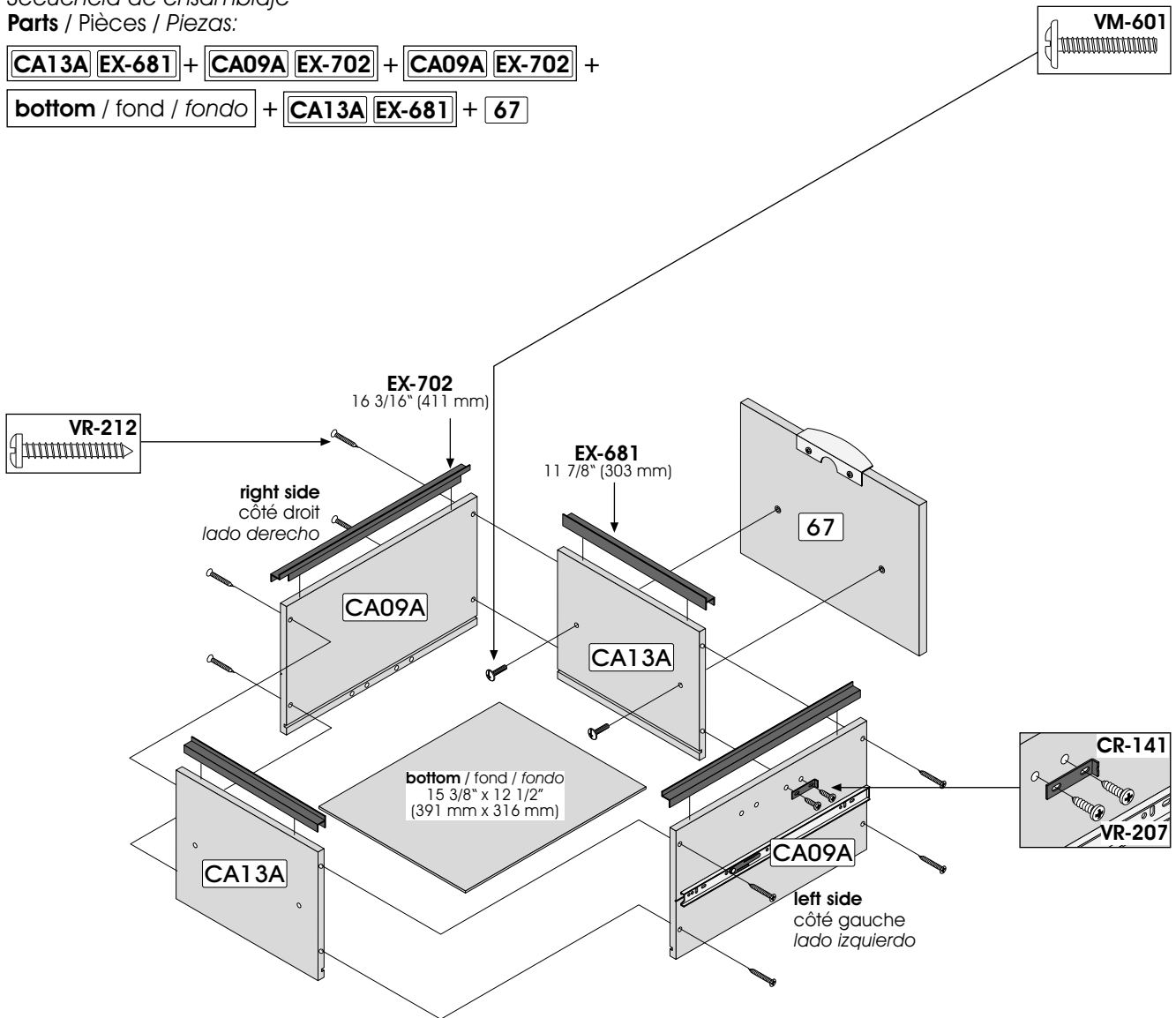

Code / Código	CR-141	EX-681	EX-702	VR-207	VM-601	VR-212
Qty / Qté / Cant.	x 1	x 2	x 2	x 2	x 2	x 8

Go to page 26 to complete the assembly.
 Aller à la page 26 pour compléter l'assemblage.
 Ir a la página 26 para completar el ensamblaje.

1 **HARDWARE INSTALLATION / INSTALLATION DES QUINCAILLERIES / INSTALACIÓN DE LAS QUINCALLAS**

Desk / Bureau / Escritorio

Left assembly
p.16 to p.34

Assemblage gauche
p.16 à p.34

Ensamblaje izquierdo
p.16 a p.34

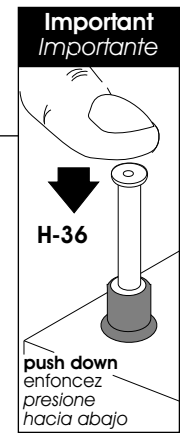
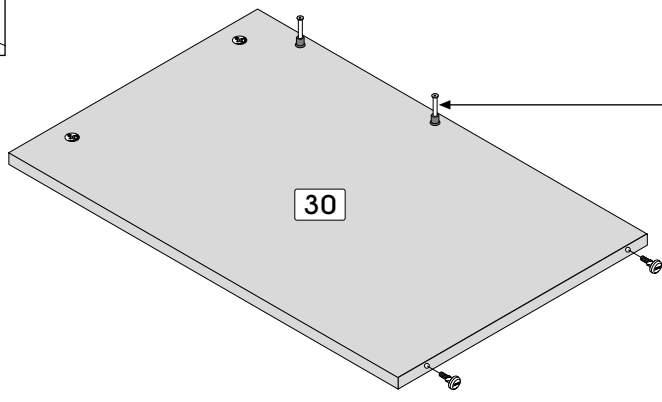
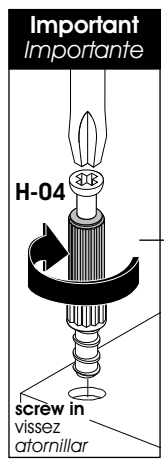
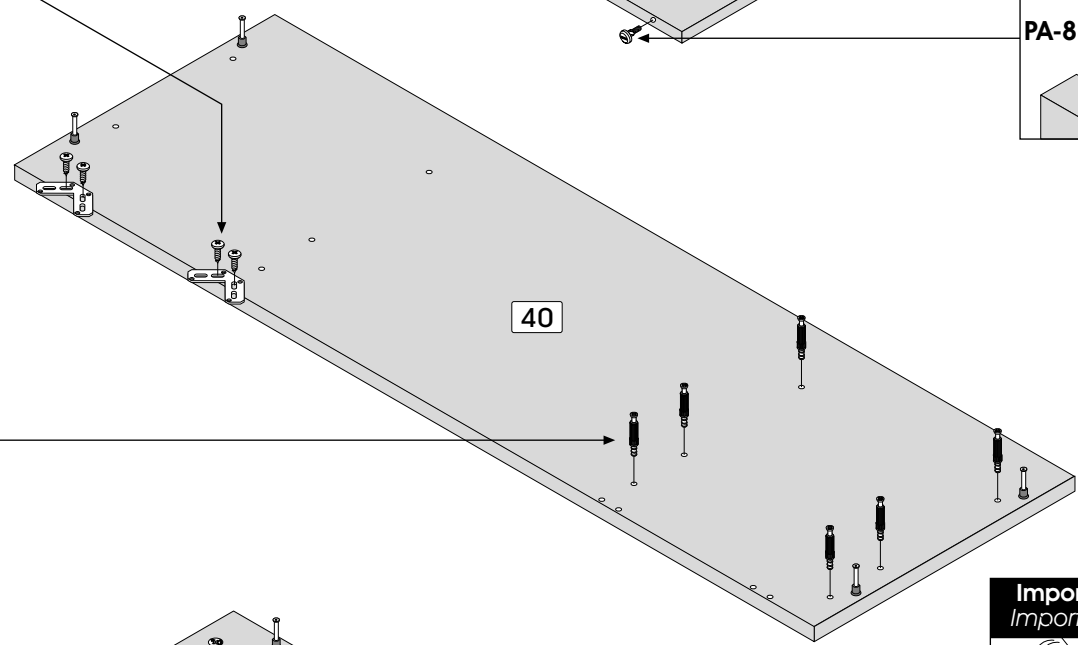
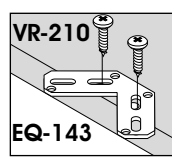
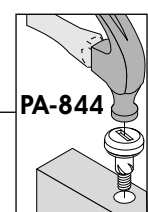
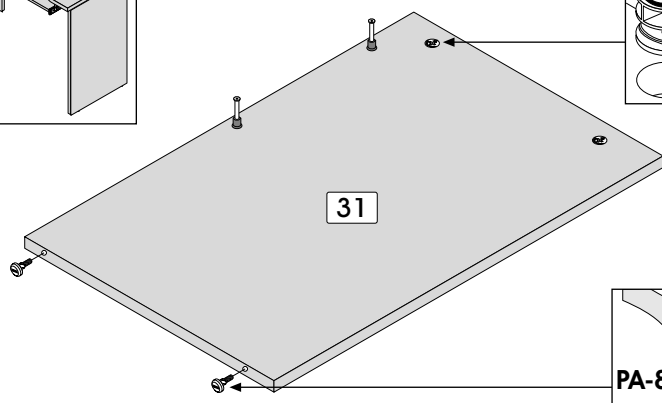
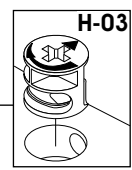
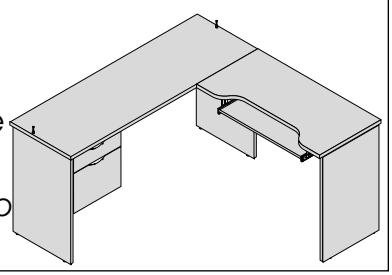

1

Code / Código	H-03	H-36	H-04	PA-844	EQ-143	VR-210
Qty / Qté / Cant.	x 4	x 8	x 6	x 4	x 2	x 4

SERVICE/SERVICIO: 1-888 8BESTAR (1-888 823-7827)

2 HARDWARE INSTALLATION / INSTALLATION DES QUINCAILLERIES / INSTALACIÓN DE LAS QUINCALLAS

Desk / Bureau / Escritorio

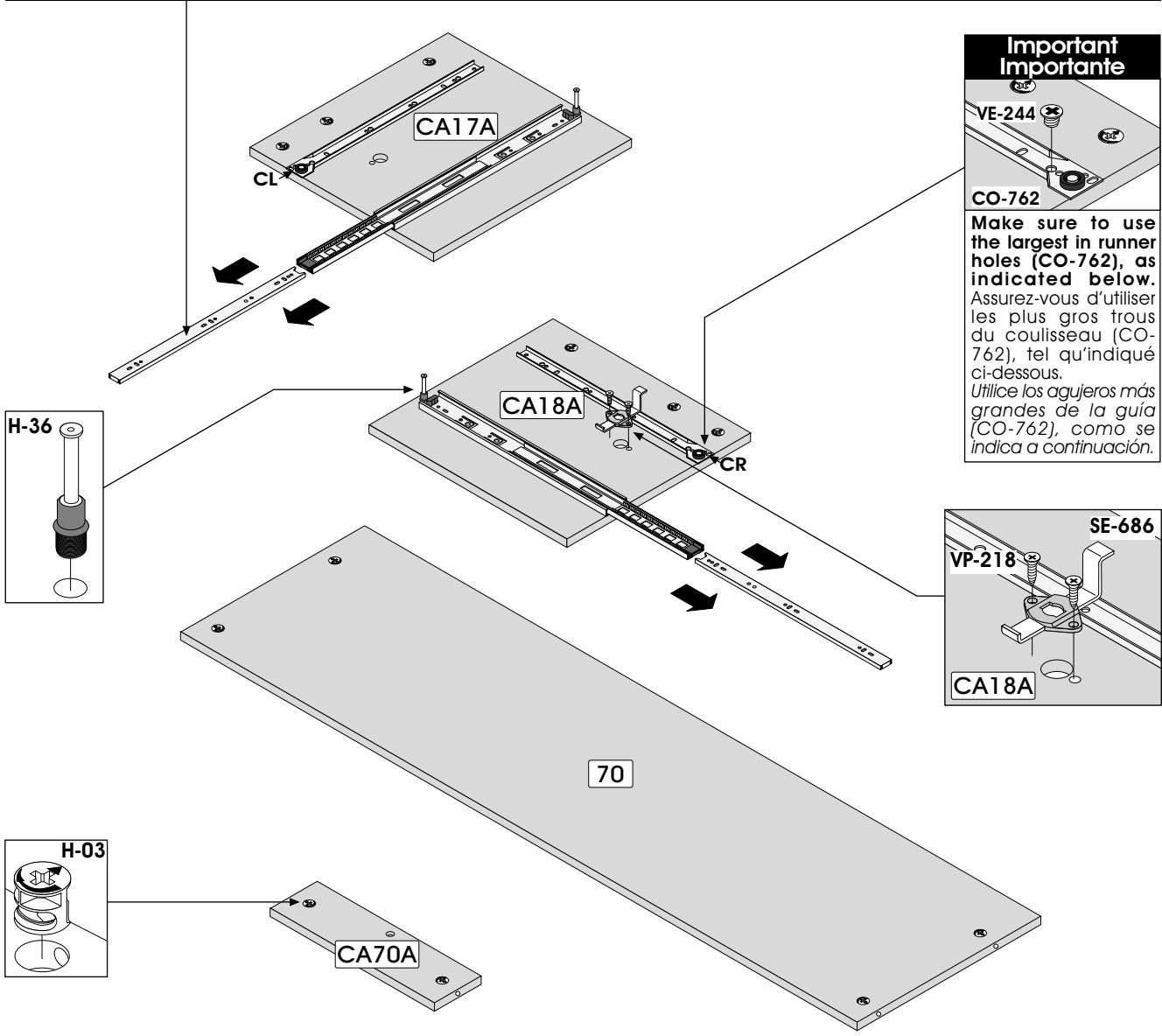
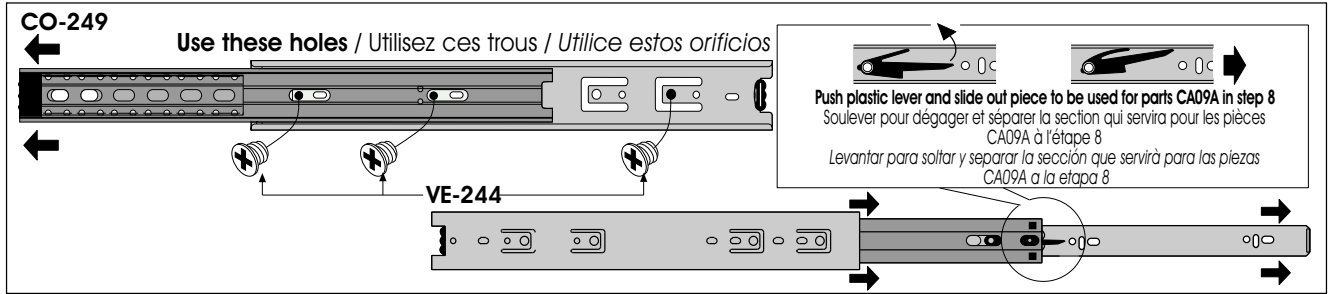

Code / Código	Code / Código					
CO-249	CO-762					
Qty / Qté / Cant.	Qty / Qté / Cant.					
x 1	x 1	x 12	x 2	x 1	x 10	x 2

SERVICE/SERVICIO: 1-888 8BESTAR (1-888 823-7827)

IMPORTANT NOTICE / NOTE IMPORTANTE / NOTA IMPORTANTE

▶ Main hardware system / Système de quincaillerie principal / Sistema principal de quincalla

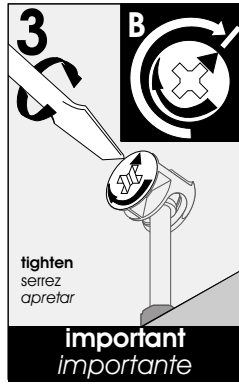
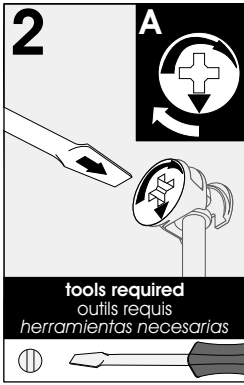
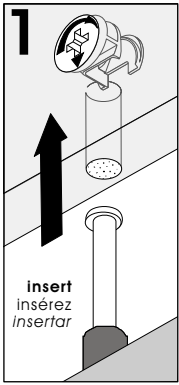

Make sure to properly tighten each cam to ensure furniture solidity. Otherwise, parts could be damaged or the user could be injured.

Assurez-vous de bien resserrer chaque rondelle pour assurer la solidité du meuble. Dans le cas contraire, des pièces pourraient être endommagées ou l'utilisateur pourrait se blesser.

Asegúrese de apretar bien cada arandela para garantizar la solidez del mueble. De lo contrario, podría provocarse daño a las piezas o las personas.

3 PRE-ASSEMBLY / PRÉ-ASSEMBLAGE / PREENSAMBLAJE

Desk / Bureau / Escritorio

Assemble on the back edge

Assemblez sur la bordure arrière

Realice el ensamblaje sobre el borde trasero

Assembling sequence

Séquence d'assemblage

Secuencia de ensamblaje

Parts / Pièces / Piezas:

70 30 31 40

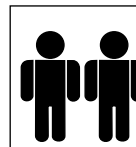

two people are required to assemble and move this model.

deux personnes sont requises pour assembler et déplacer ce modèle.

se necesitan dos personas para ensamblar y desplazar este mueble.

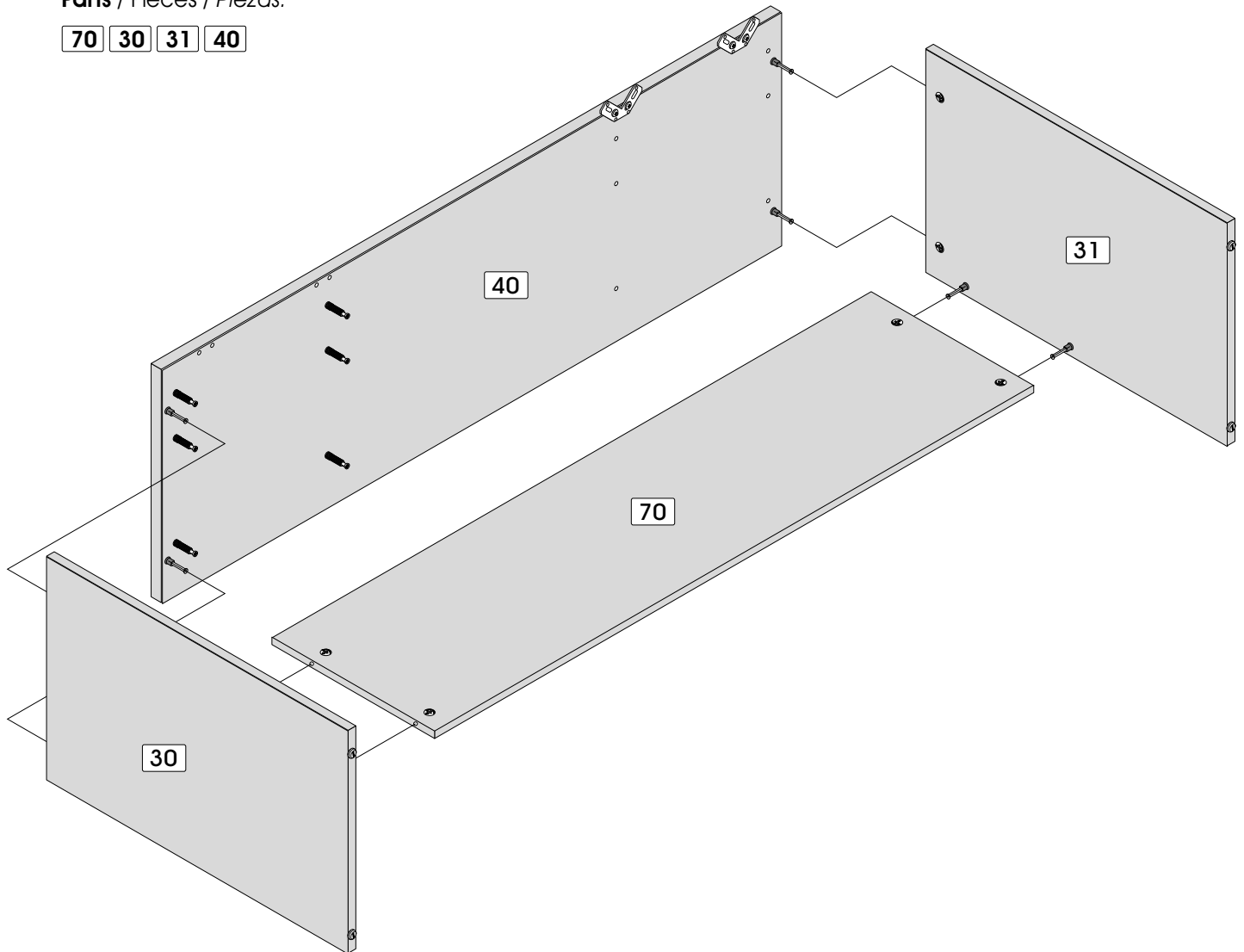

SERVICE/SERVICIO: 1-888 8BESTAR (1-888 823-7827)

Desk / Bureau / Escritorio





two people are required to assemble and move this model.
deux personnes sont requises pour assembler et déplacer ce modèle.
se necesitan dos personas para ensamblar y desplazar este mueble.

Assemble on the back edge
Assemblez sur la bordure arrière
Realice el ensamblaje sobre el borde trasero

Assembling sequence
Séquence d'assemblage
Secuencia de ensamblaje
Parts / Pièces / Piezas:

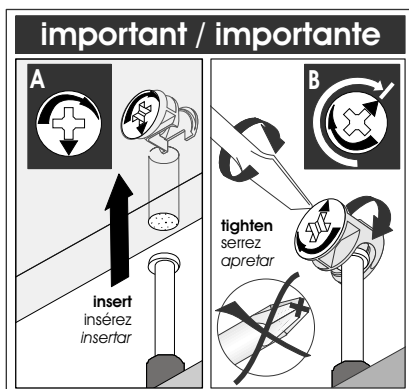
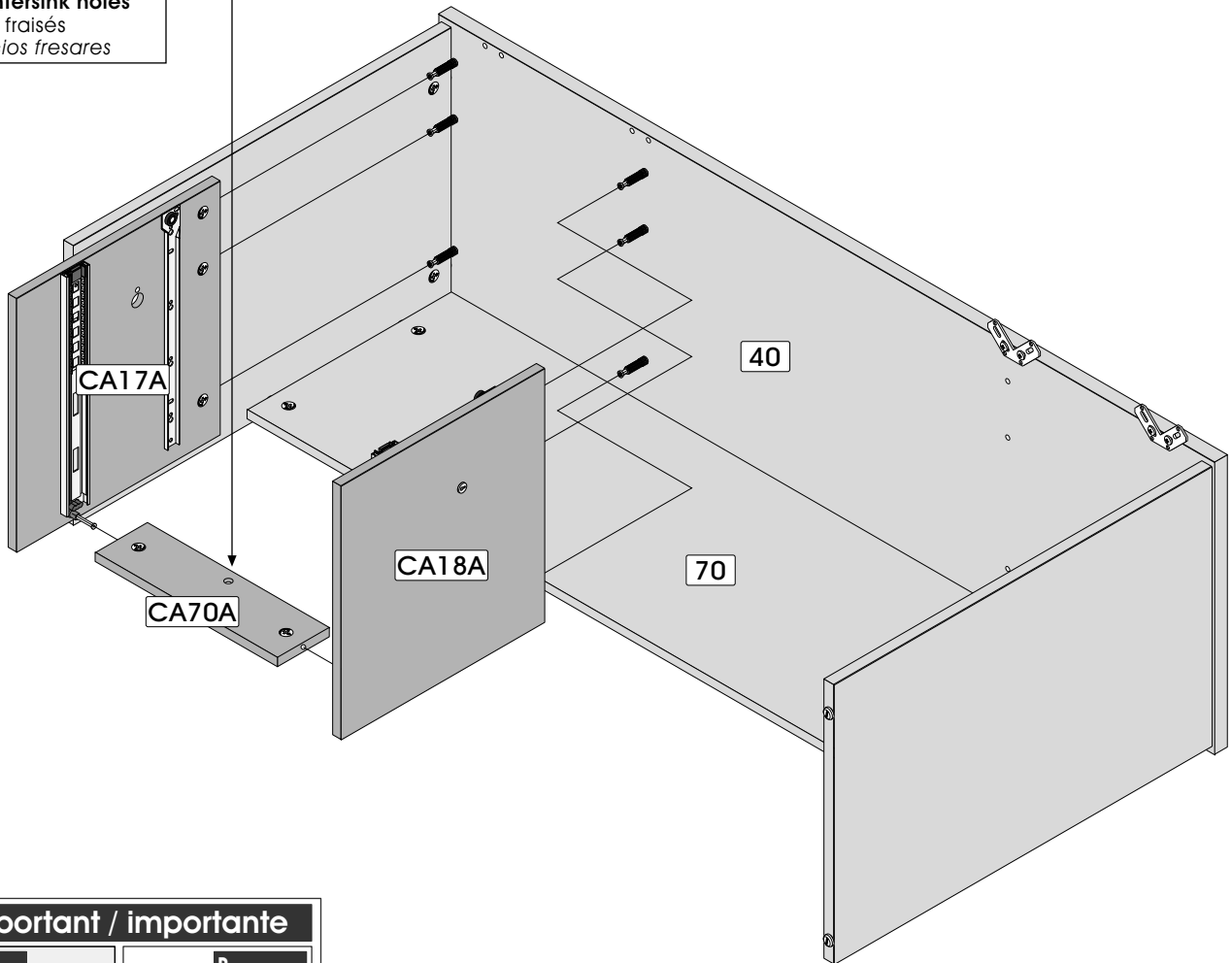
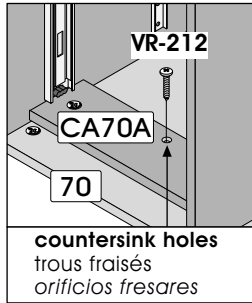
CA18A CA70A CA17A + **40**



4	
Code / Código	VR-212
Qty / Qté / Cant.	x 1

5 HARDWARE INSTALLATION / INSTALLATION DES QUINCAILLERIES / INSTALACIÓN DE LAS QUINCALLAS

Desk / Bureau / Escritorio

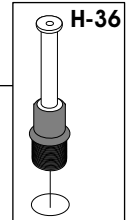
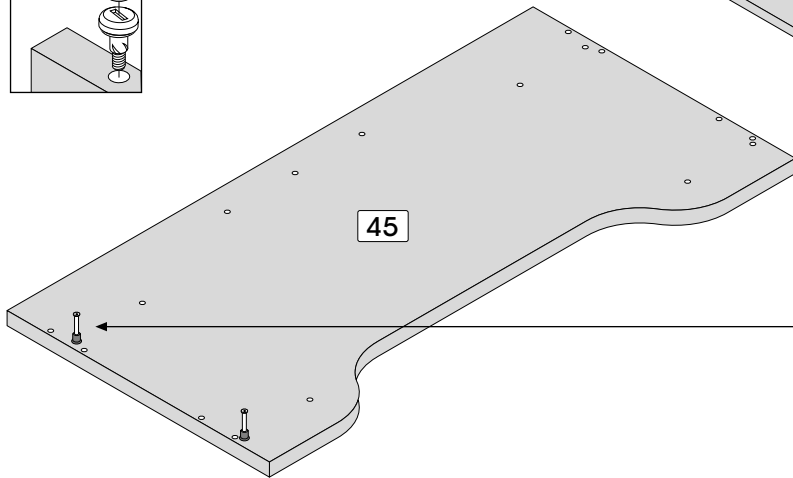
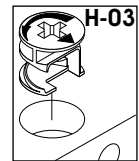
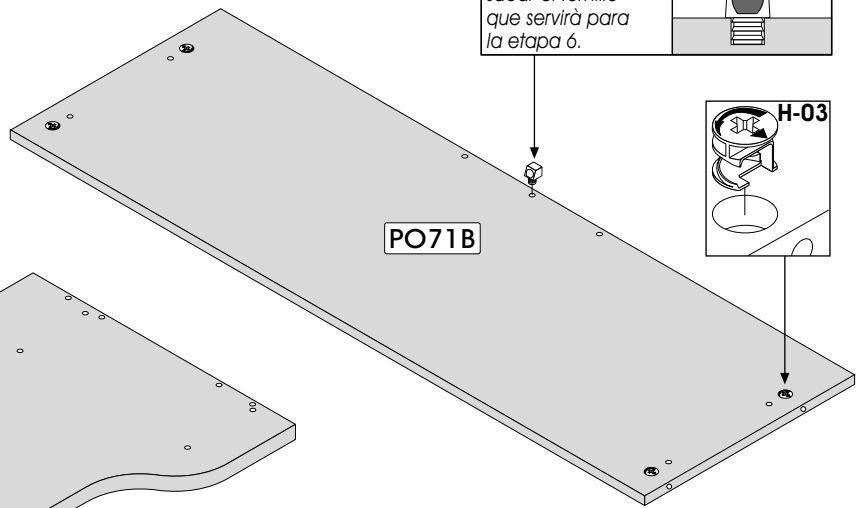
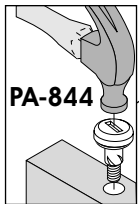
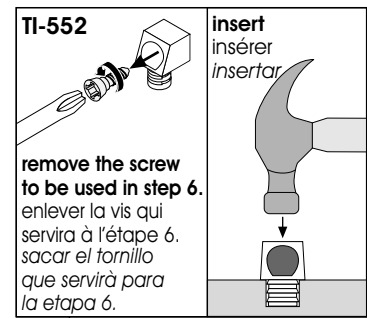
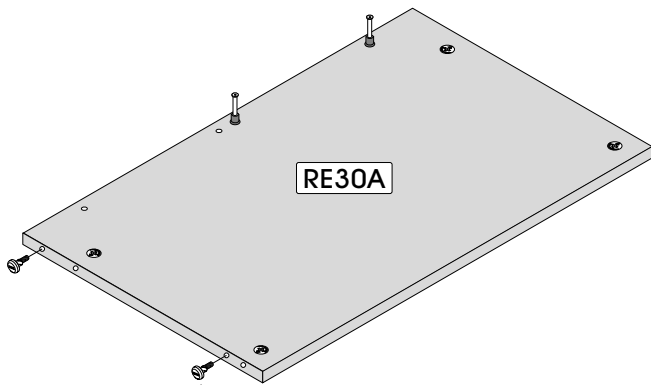
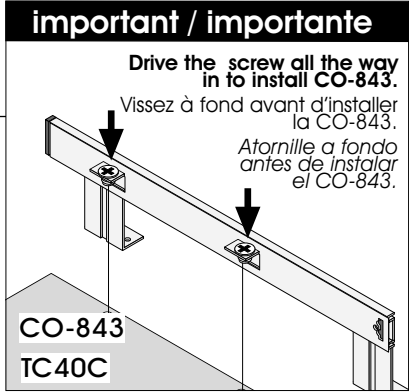
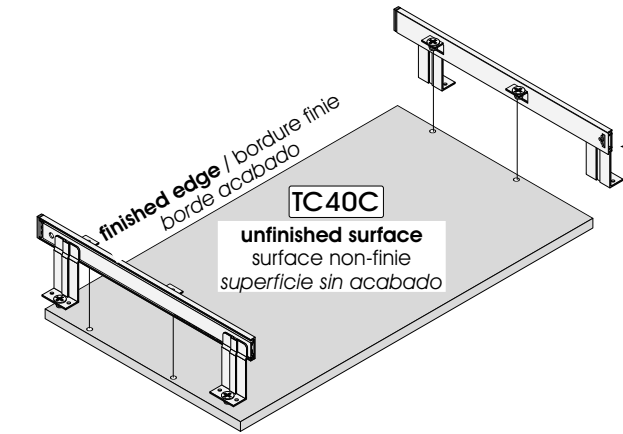

5

Code / Código	H-03	H-36	PA-844	TI-552	CO-843
Qty / Qté / Cant.	x 8	x 4	x 2	x 1	x 1

SERVICE/SERVICIO: 1-888 8BESTAR (1-888 823-7827)

Desk / Bureau / Escritorio

Assemble upside down

Assemblez en position renversée

Realice el ensamblaje en posición invertida

Assembling sequence

Séquence d'assemblage

Secuencia de ensamblaje

Parts / Pièces / Piezas:

45 RE30A PO71B TC40C



two people are required to assemble and move this model.

deux personnes sont requises pour assembler et déplacer ce modèle.
se necesitan dos personas para ensamblar y desplazar este mueble.

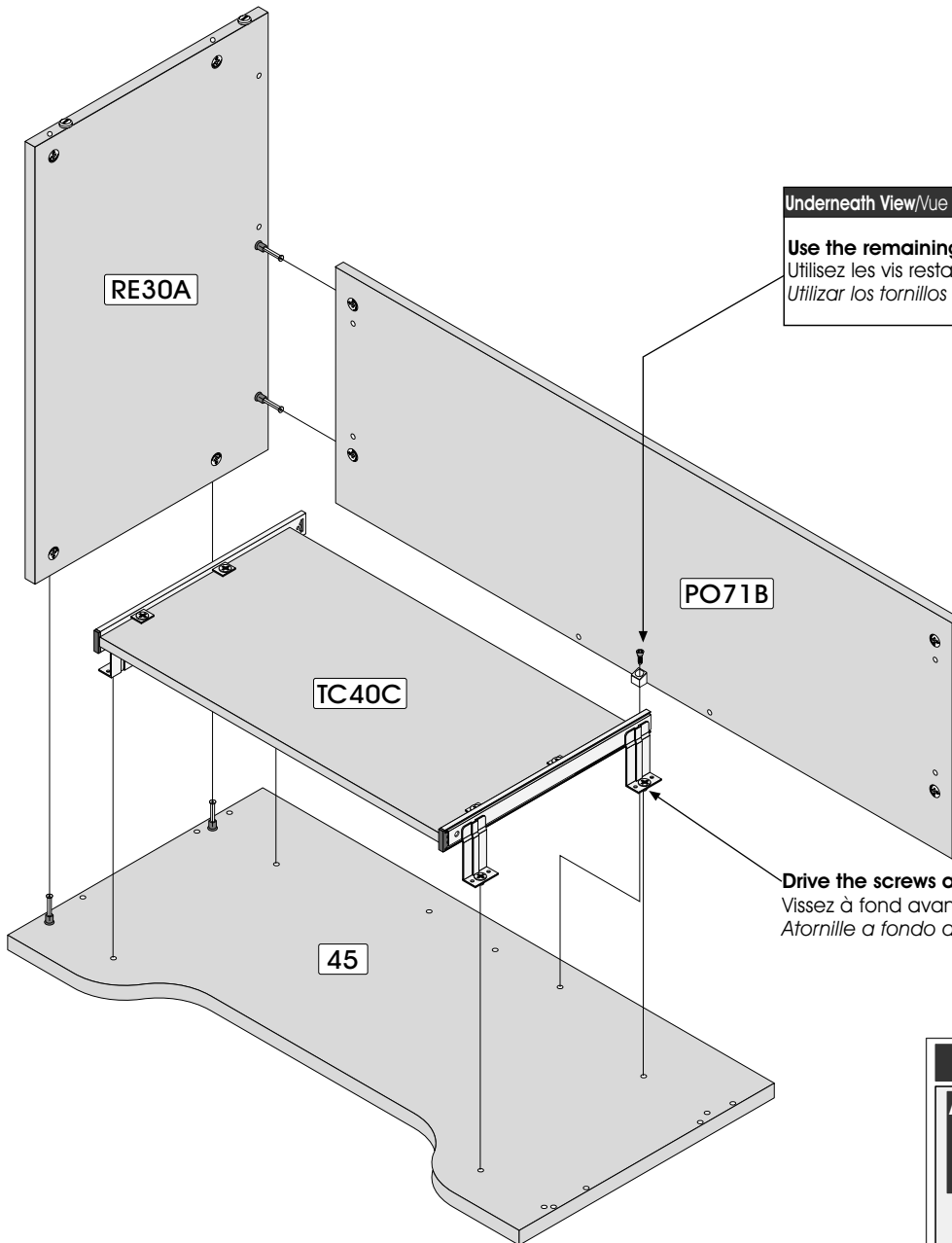

Underneath View/Vue de dessous/Visión de debajo

PO71B

Use the remaining screws from step 5.

Utilisez les vis restantes de l'étape 5.

Utilizar los tornillos restantes de la etapa 5.

TI-552



45

**Drive the screws all the way in to install CO-843.**

Vissez à fond avant d'installer la CO-843.

Atornille a fondo antes de instalar el CO-843.

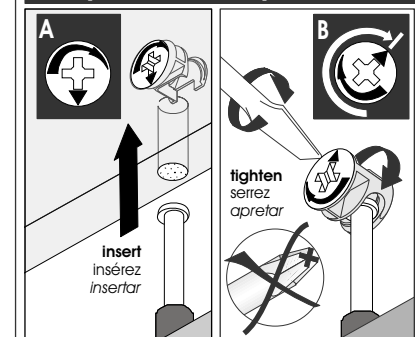
important / importante

7 ASSEMBLY / ASSEMBLAGE / ENSAMBLAJE

Desk / Bureau / Escritorio



two people are required to assemble and move this model.

deux personnes sont requises pour assembler et déplacer ce modèle.
se necesitan dos personas para ensamblar y desplazar este mueble.

Assembling sequence
Séquence d'assemblage
Secuencia de ensamblaje
Parts / Pièces / Piezas:

31 40 + **45 PO71B**

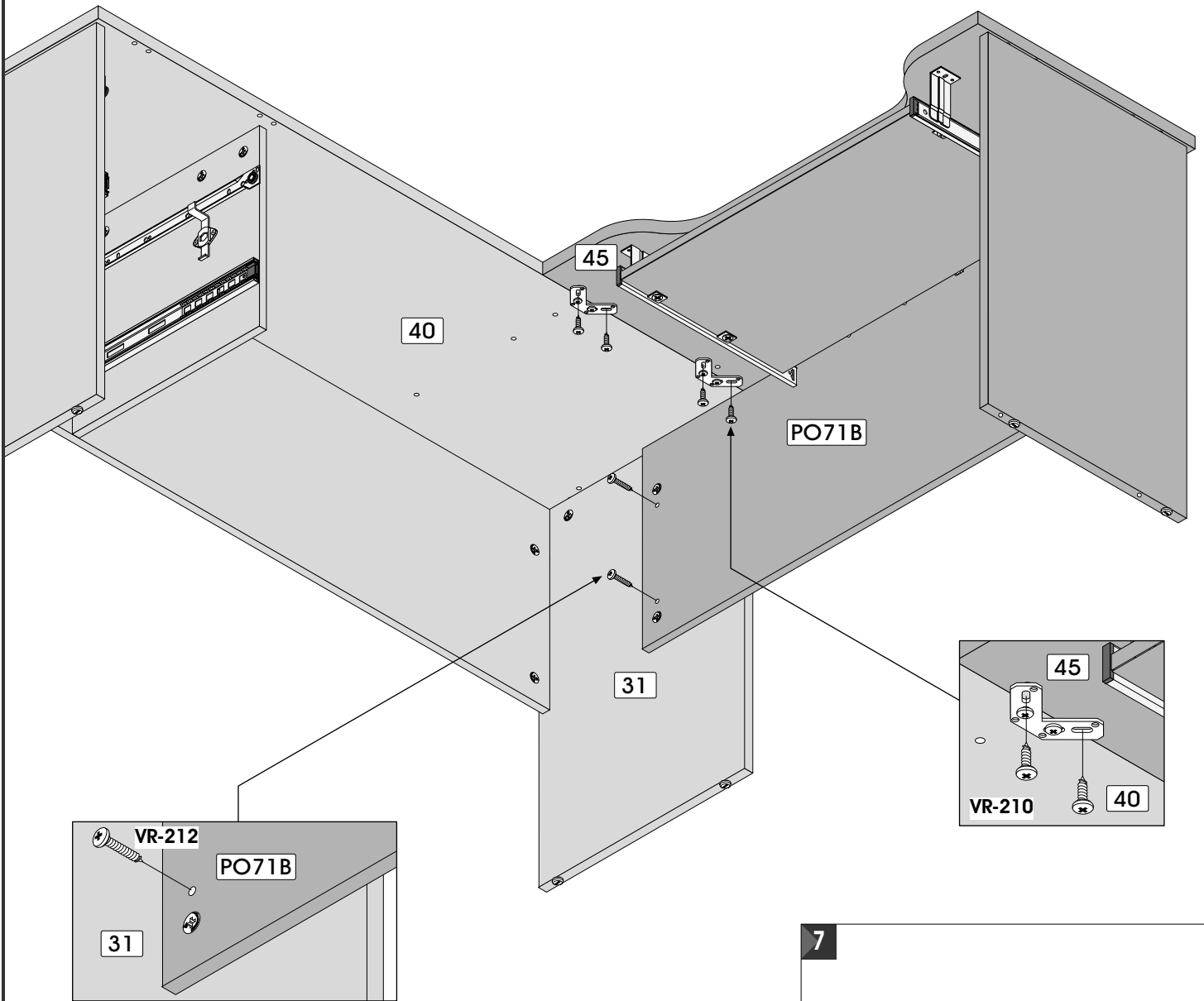

7	
Code / Código	VR-210
Qty / Qté / Cant.	x 4
Code / Código	VR-212
Qty / Qté / Cant.	x 2

Drawers / Tiroirs / Cajones

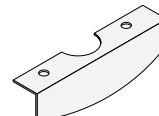
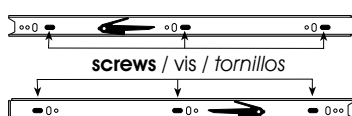
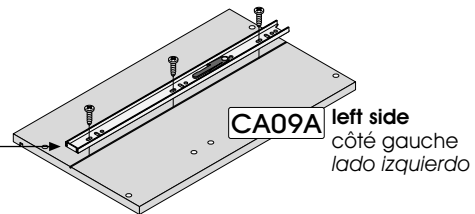
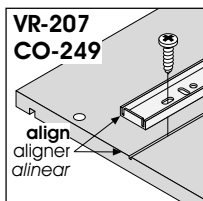
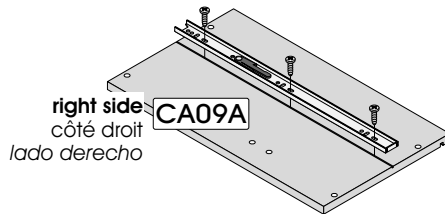
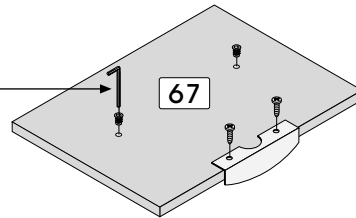
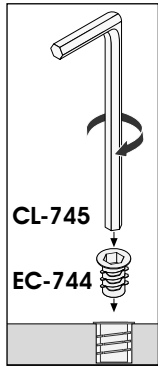

Code / Código

CO-249

EC-744

CL-745

PO-842

VR-207

Qty / Qté / Cant.

x 1

x 4

x 1

x 2

x 10

Drawer / Tiroir / Cajón

Assembling sequence

Séquence d'assemblage

Secuencia de ensamblaje

Parts / Pièces / Piezas:

CA05A CA03A CA03A + bottom / fond / fondo + CA05A 66

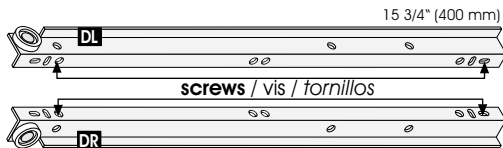
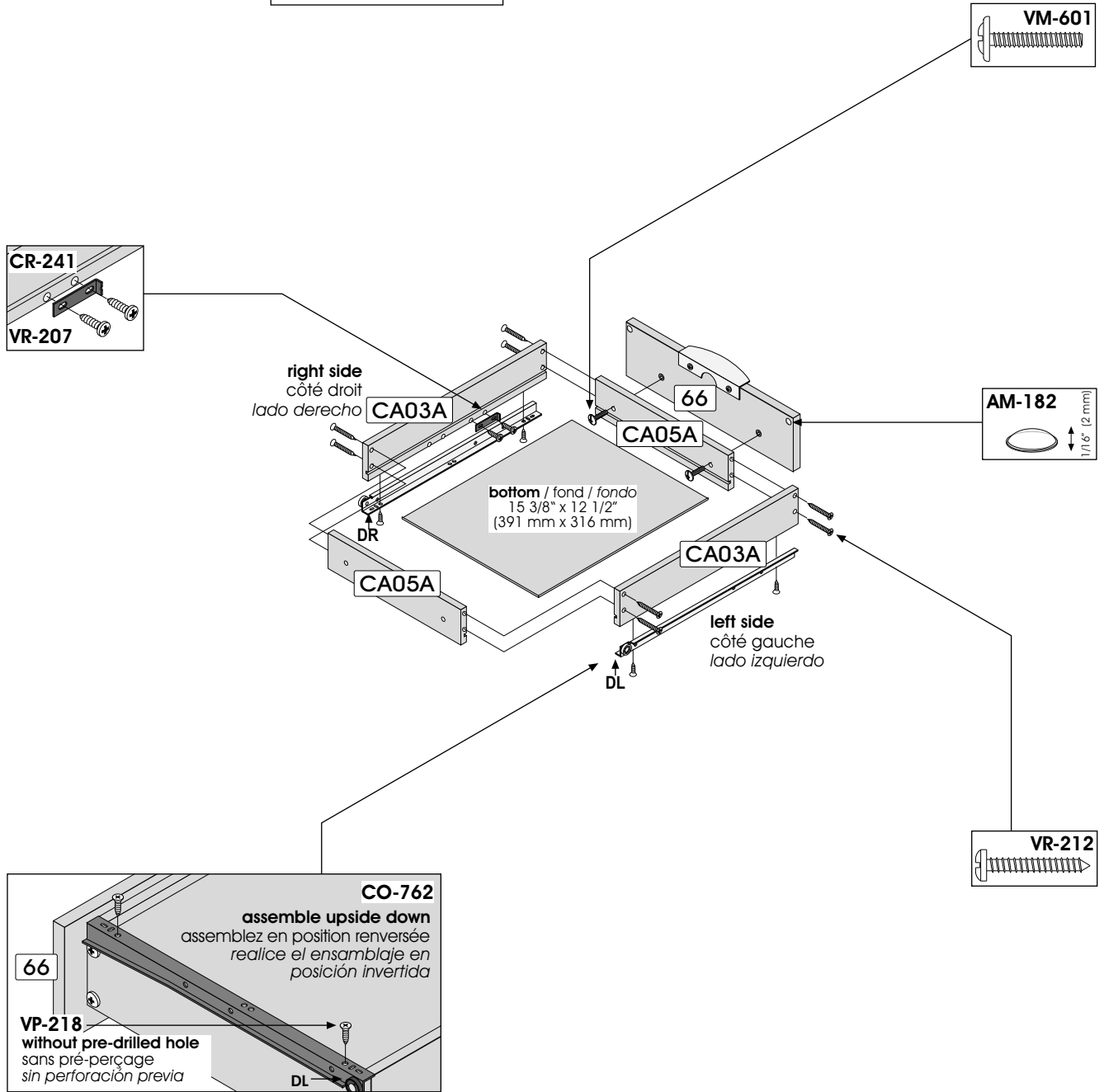

Code / Código

CO-762

Qty / Qté / Cant.

x 1

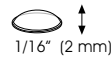

AM-182

x 2



CR-141

x 1



VP-218

x 4

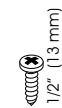

VR-207

x 2



VM-601

x 2



VR-212

x 8

Assembling sequence
 Séquence d'assemblage
 Secuencia de ensamblaje
Parts / Pièces / Piezas:

CA13A EX-681 + **CA09A EX-702** + **CA09A EX-702** +
bottom / fond / fondo + **CA13A EX-681** + **67**

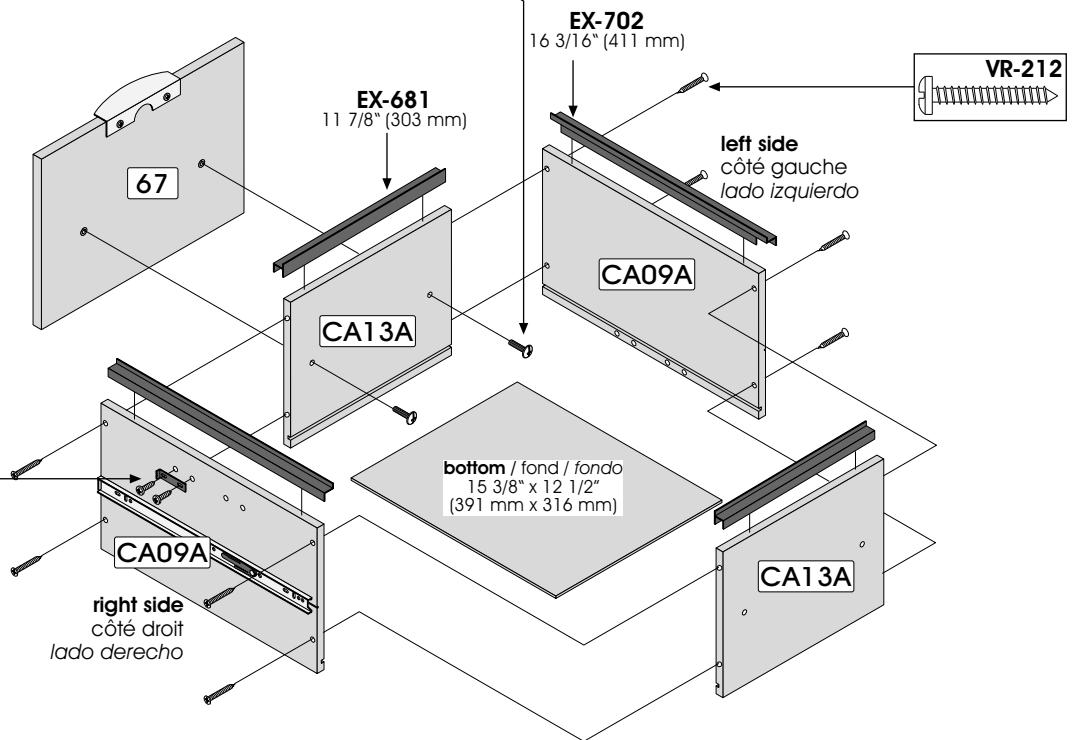
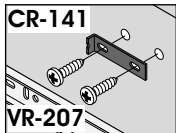
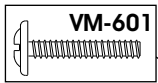

Code / Código	CR-141	EX-681	EX-702	VR-207	VM-601	VR-212
Qty / Qté / Cant.	x 1	x 2	x 2	x 2	x 2	x 8

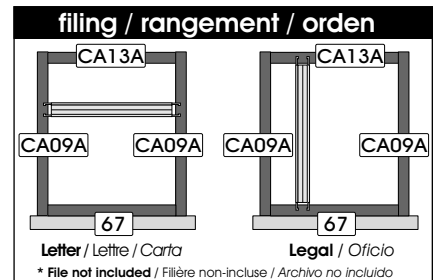

Hutch / Étagère / Estantería

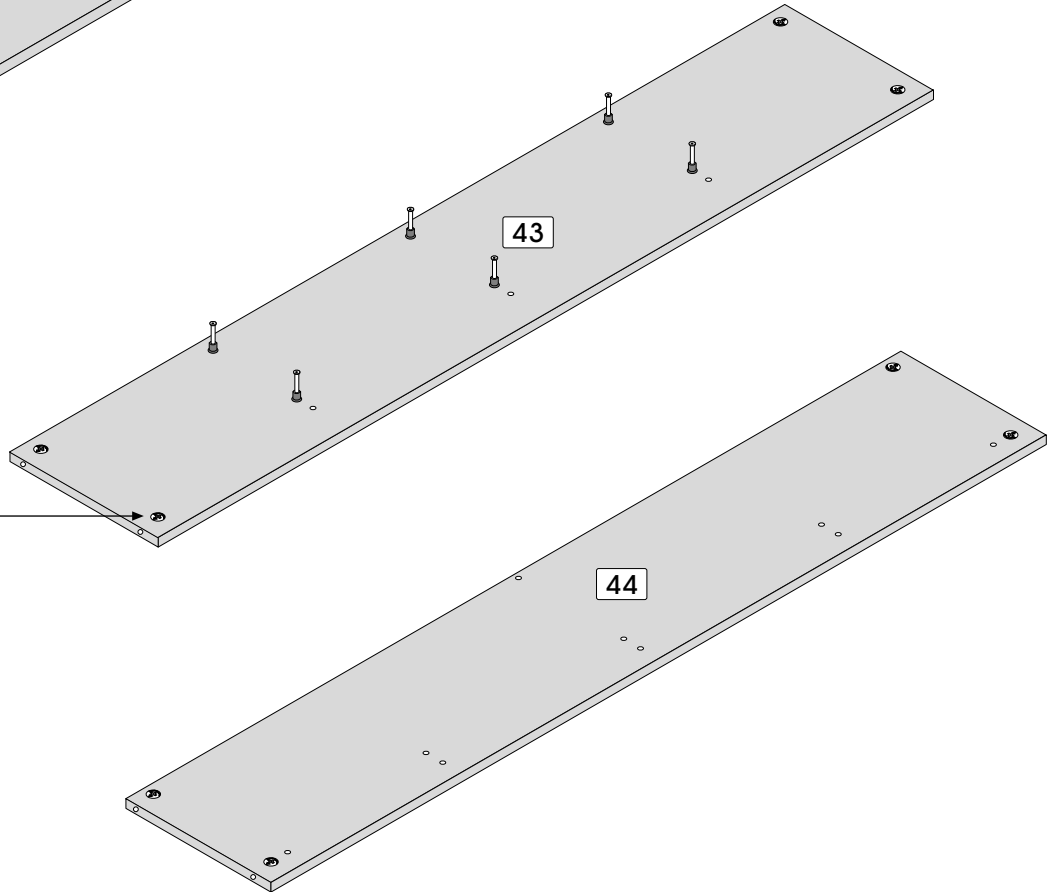
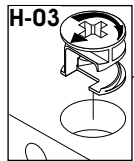
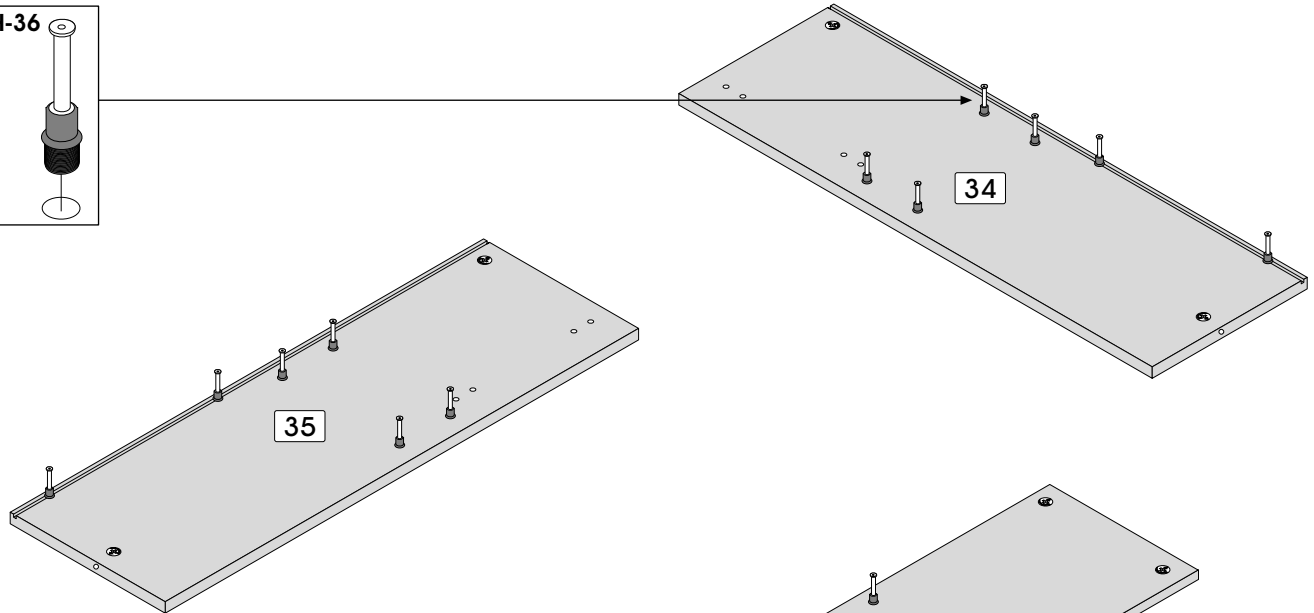
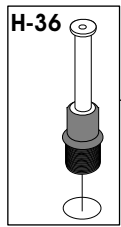

Code / Código

H-03

H-36

Qty / Qté / Cant.

x 12

x 18

Hutch / Étagère / Estantería

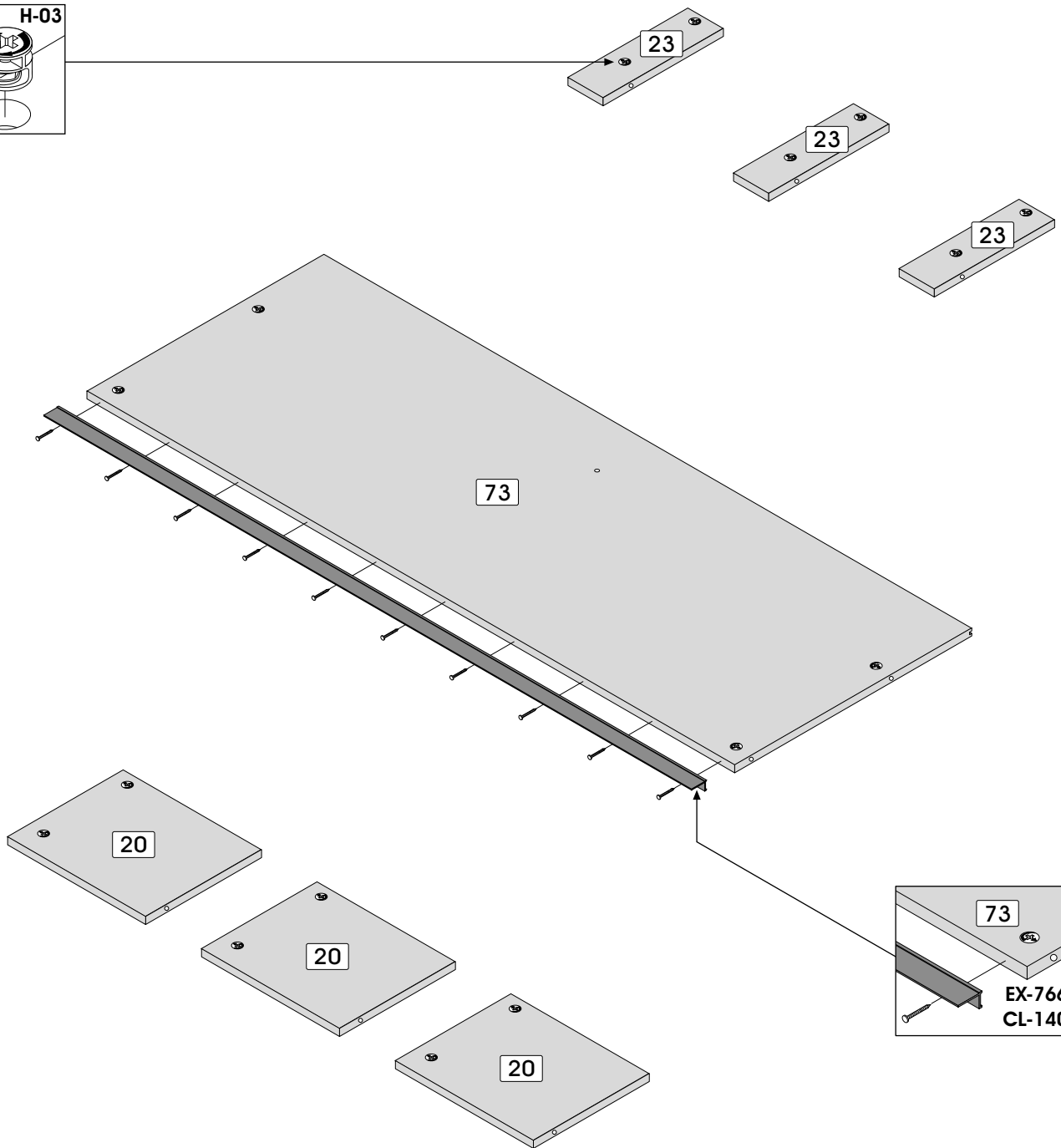
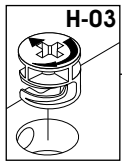

12



H-03



EX-766



CL-140

Code / Código

Qty / Qté / Cant.

x 16

x 1

-

13 PRE-ASSEMBLY / PRÉ-ASSEMBLAGE / PREENSAMBLAJE

Hutch / Étagère / Estantería

Assemble on the back edge

Assemblez sur la bordure arrière

Realice el ensamblaje sobre el borde trasero

Assembling sequence

Séquence d'assemblage

Secuencia de ensamblaje

Parts / Pièces / Piezas:

73 34 43 20 20 20 23 23 23 44 EQ-314 35

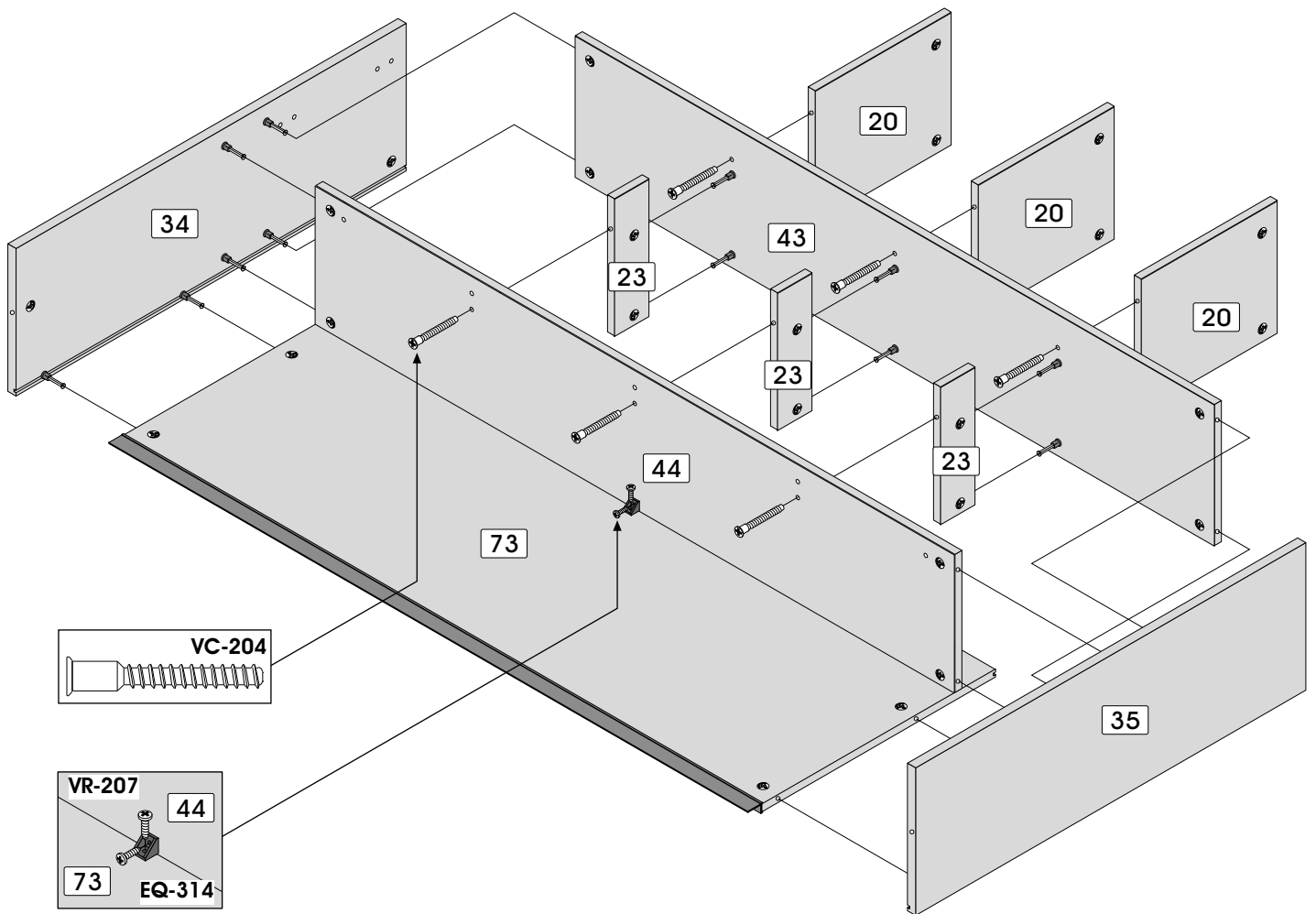
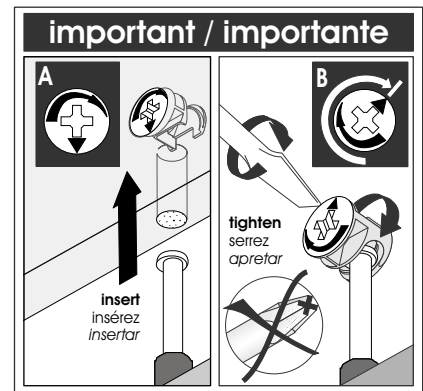

13

Code / Código

EQ-314

VR-207

VC-204

Qty / Qté / Cant.

x 1

x 2

x 6





two people are required to assemble and move this model.

deux personnes sont requises pour assembler et déplacer ce modèle.
se necesitan dos personas para ensamblar y desplazar este mueble.

SERVICE/SERVICIO: 1-888 8BESTAR (1-888 823-7827)

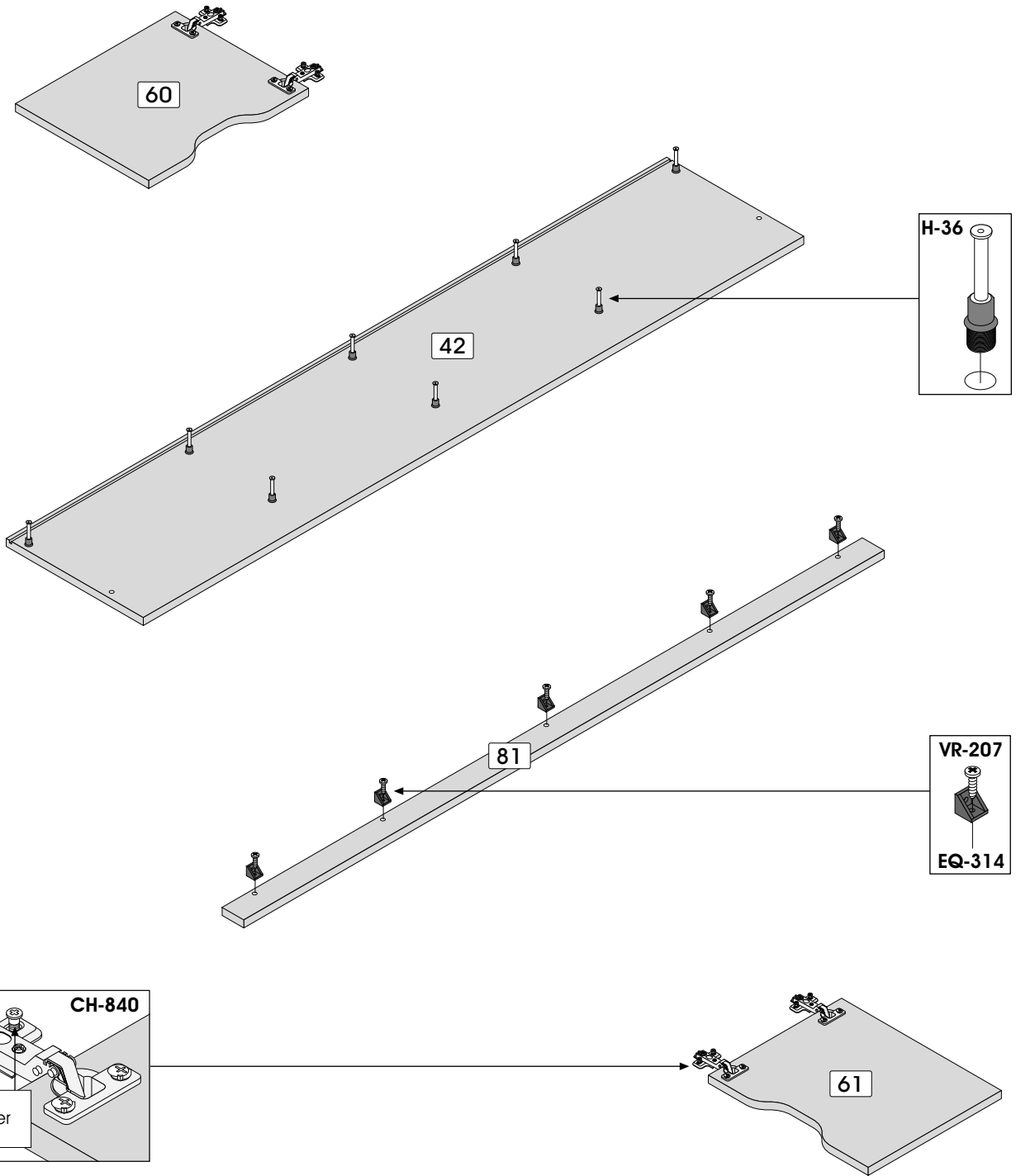
Hutch / Étagère / Estantería

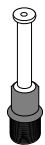
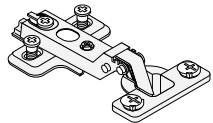

				
Code / Código	H-36	CH-840	EQ-314	VR-207
Qty / Qté / Cant.	x 8	x 4	x 5	x 5

Hutch / Étagère / Estantería



two people are required to assemble and move this model.
deux personnes sont requises pour assembler et déplacer ce modèle.
se necesitan dos personas para ensamblar y desplazar este mueble.

Assembling sequence
Séquence d'assemblage
Secuencia de ensamblaje
Parts / Pièces / Piezas:

34 20 35 44 + Back / dos / panel trasero + 42 81

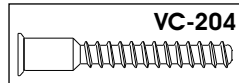

VC-204

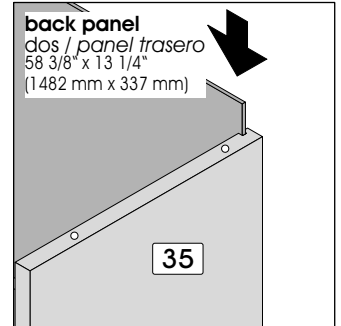

back panel
dos / panel trasero
58 3/8" x 13 1/4"
(1482 mm x 337 mm)

back panel
dos / panel trasero
58 3/8" x 13 1/4"
(1482 mm x 337 mm)

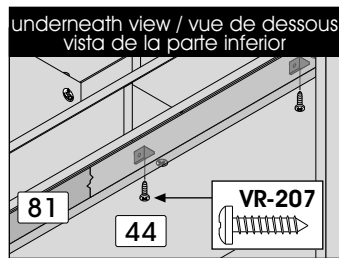

underneath view / vue de dessous
vista de la parte inferior

VR-207

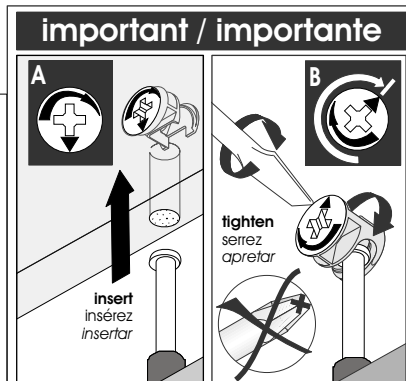

important / importante

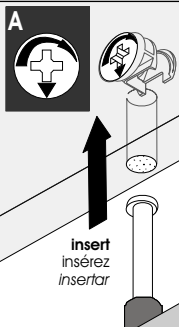

insert
insérez
insertar

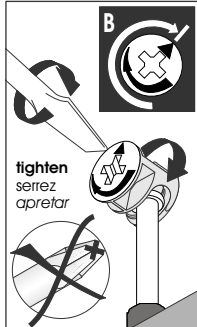

tighten
serrez
apretar

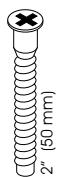

VC-204



VR-207

Code / Código

Qty / Qté / Cant.

x 5

x 2

16 INSTALLATION / INSTALLATION / INSTALACIÓN

Hutch / Étagère / Estantería

Assembling sequence

Séquence d'assemblage

Secuencia de ensamblaje

Parts / Pièces / Piezas:

40 + 34 35

 **two people are required to assemble and move this model.**
deux personnes sont requises pour assembler et déplacer ce modèle.
se necesitan dos personas para ensamblar y desplazar este mueble.

important / importante

A



↑
insert
insérez
insertar

B



tighten
serrez
apretar

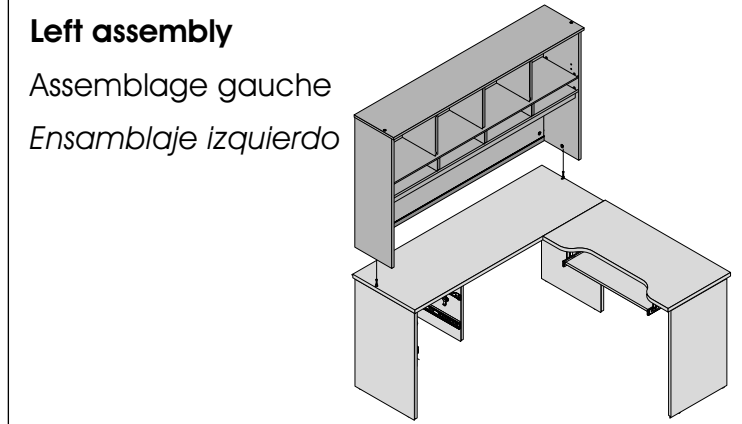
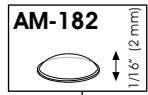
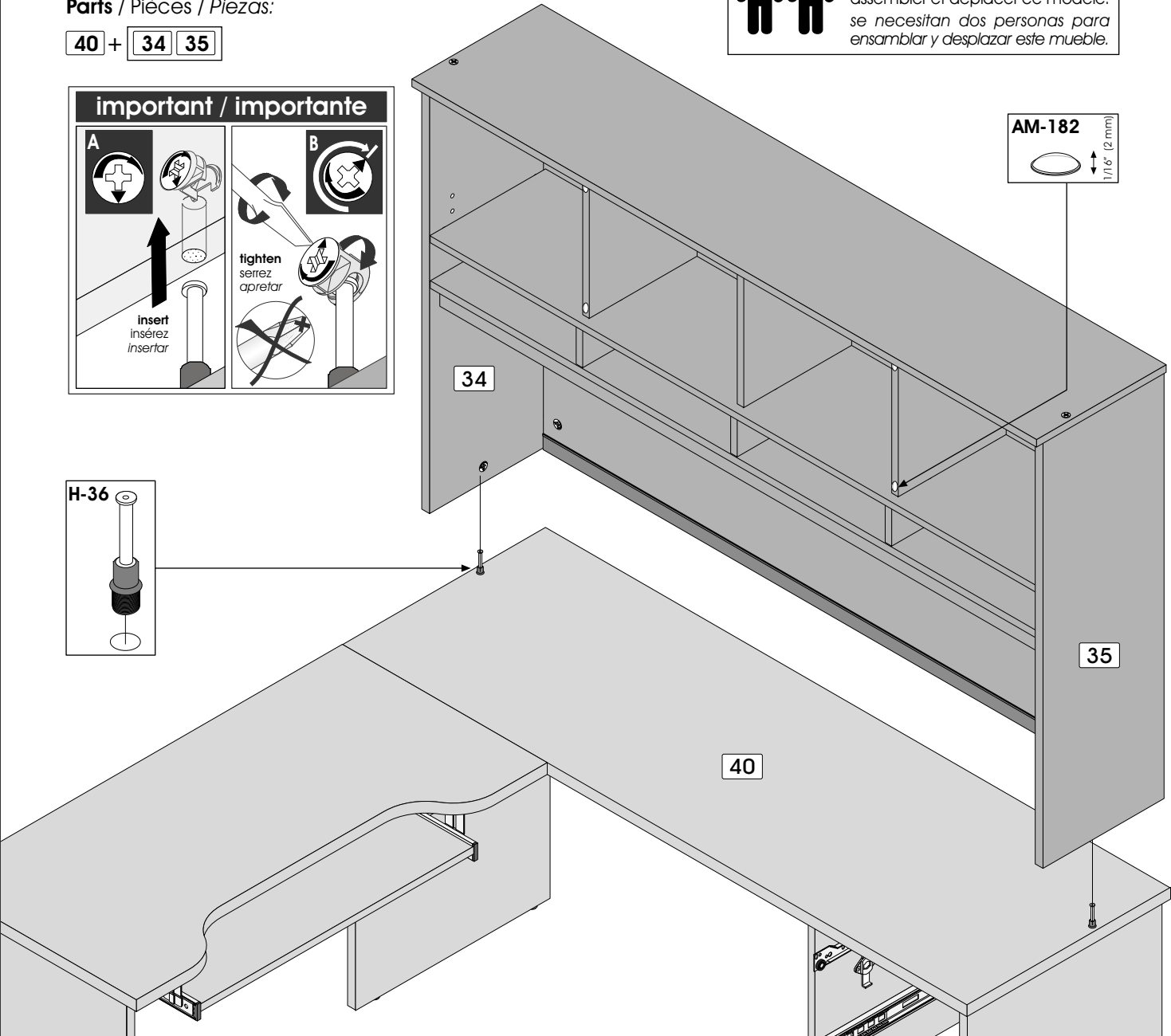
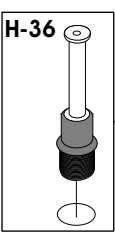

Code / Código	AM-182	H-36
Qty / Qté / Cant.	x 4	x 2

SERVICE/SERVICIO: 1-888 8BESTAR (1-888 823-7827)

17 INSTALLATION / INSTALLATION / INSTALACIÓN

Doors / Portes / Puertas

Use screw A for horizontal adjustment, screw B for depth adjustment and screws C for vertical adjustment.

Utilisez la vis A pour l'ajustement horizontal, les vis B pour l'ajustement en profondeur et les vis C pour l'ajustement vertical.

Utilice el tornillo A para realizar el ajuste horizontal, los tornillos B para el ajuste de profundidad y los tornillos C para el ajuste vertical.

To remove hinges, start by loosening these two screws to free the locking system.

Pour enlever les pentures, desserrez ces deux vis d'abord pour libérer le système de verrouillage.

Para retirar las bisagras, afloje primero estos dos tornillos para liberar el sistema de fijación.

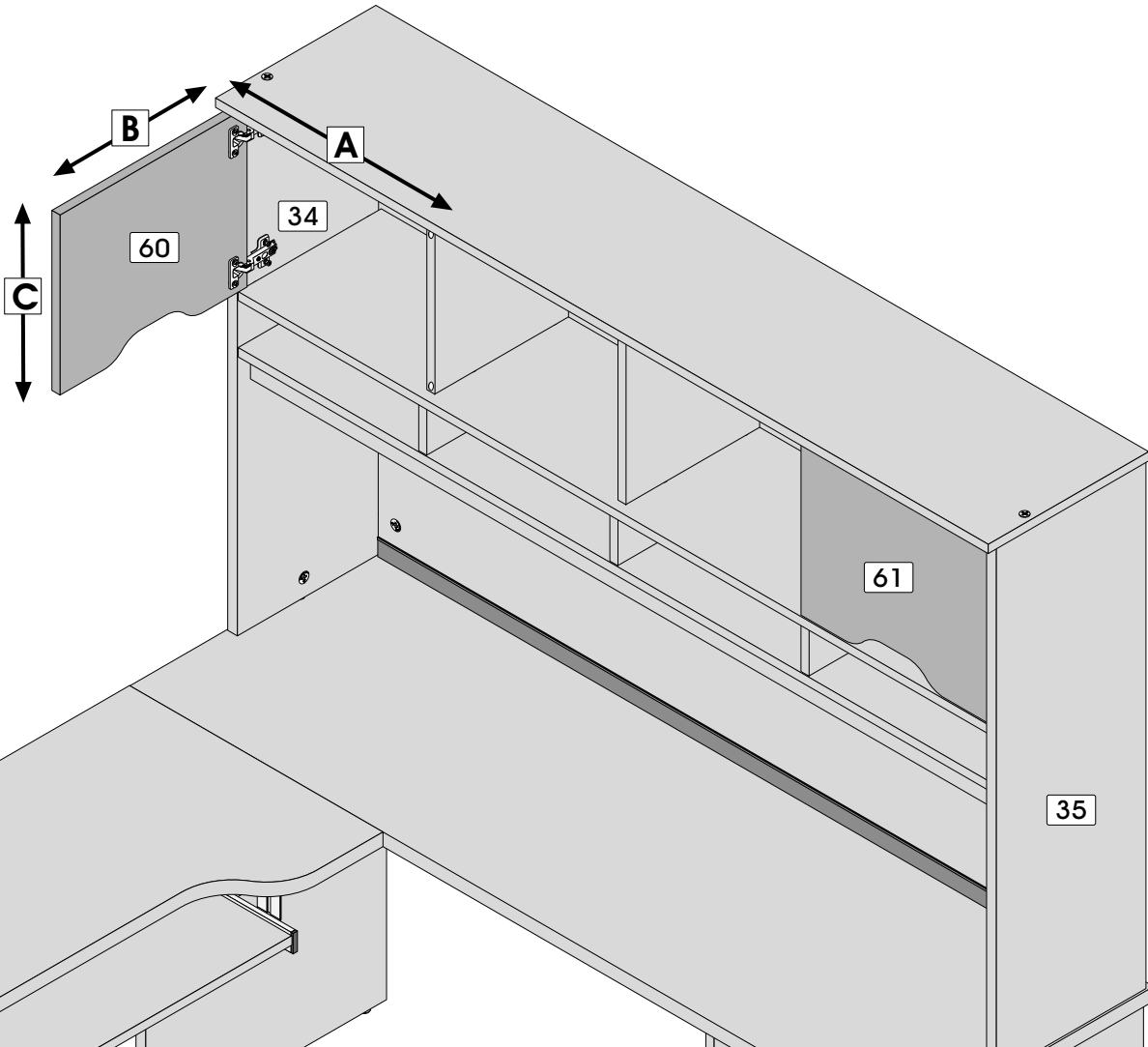
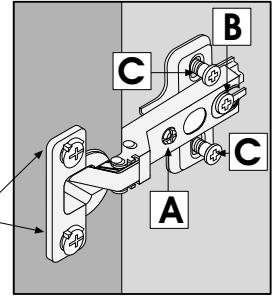

Left assembly

Assemblage gauche

Ensamblaje izquierdo

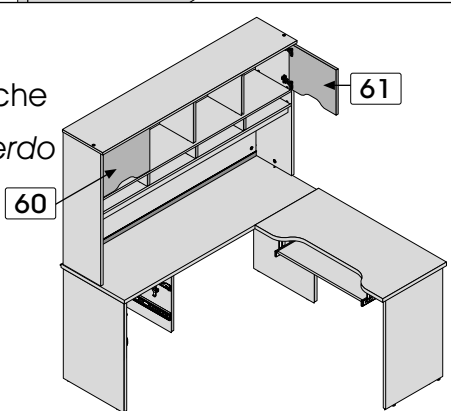

SERVICE/SERVICIO: 1-888 8BESTAR (1-888 823-7827)

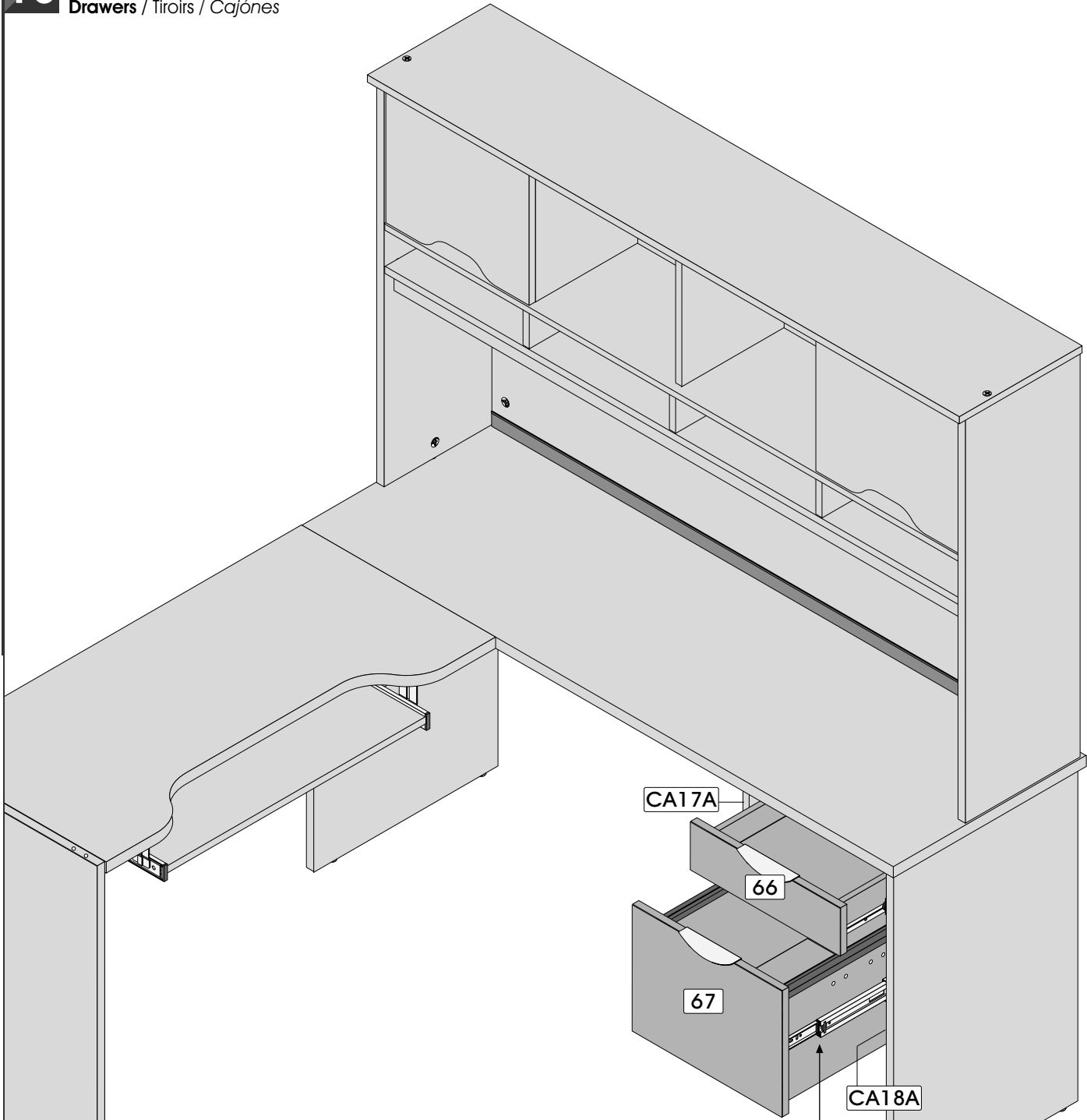

Left assembly

Assemblage gauche

Ensamblaje izquierdo

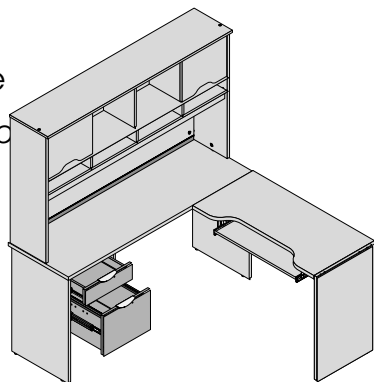

Important/Importante

Ball bearings must be on front part of slider when installing drawers.

Les roulements à billes doivent être sur la partie avant du coulisseau lors de l'installation des tiroirs.

Los cojinetes de bolas deben ubicarse sobre la parte delantera de guía en el momento de instalar los cajones.

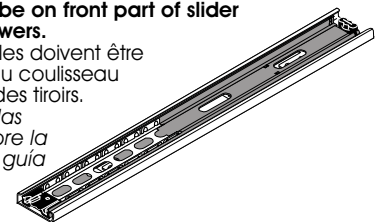

Important/Importante

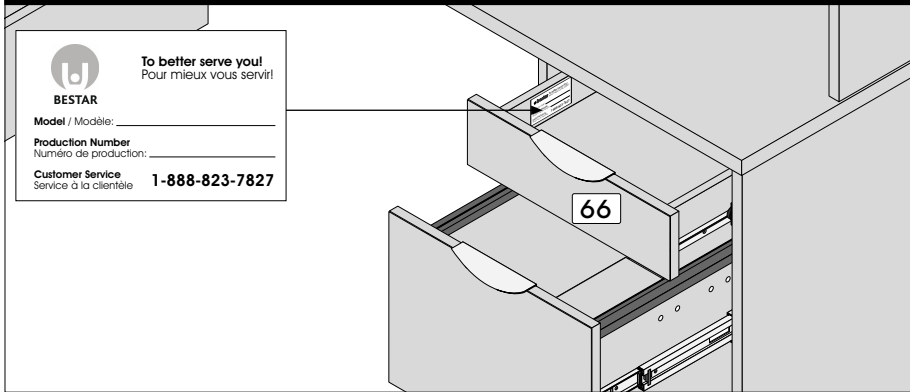

For future reference and to better serve you, please apply the self-adhesive sticker in an accessible space such as inside a drawer.

Pour mieux vous servir en cas de besoin, veuillez apposer l'autocollant dans un endroit facilement accessible tel que l'intérieur d'un tiroir.

Para uno mejor servicio en caso de necesidad, poner la etiqueta en uno lugar de fácil acceso como por ejemplo al interior de un cajón.

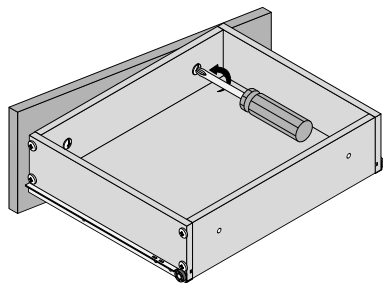

After installing drawers into cabinet, adjust drawer fronts and tighten screws VM-601.

Après avoir installé les tiroirs dans le meuble, ajustez les devants de tiroirs et resserrez les vis VM-601.

Después de instalar los cajones en el mueble, ajuste las partes delanteras de los cajones y vuelva a atornilla a fondo los tornillos VM-601.

When you have completed the assembly of your new furniture, install plastic caps

Lorsque vous avez complété l'assemblage de votre meuble, installez les capuchons de plastique
Una vez que haya completado el ensamblaje del mueble, coloque los capuchones de plástico

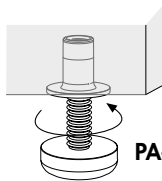
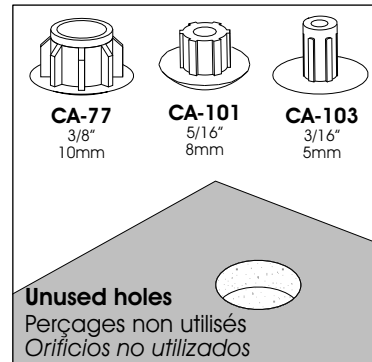
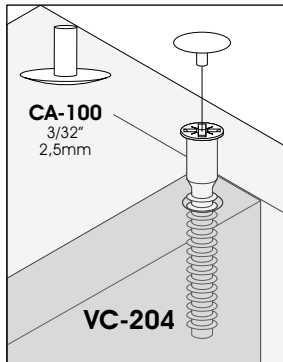
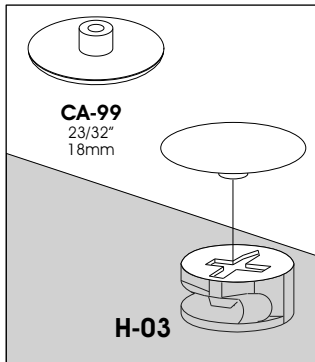

To level your furniture, use leg levelers.

Pour niveler votre meuble utilisez les pattes ajustables.

Para nivelar su mueble utilice las patas ajustables.

PRODUCT CARE / ENTRETIEN DU PRODUIT / MANTENIMIENTO DEL PRODUCTO

Avoid placing the furniture in the sunlight or near a source of heat. Use a soft dry cloth for dusting. To clean heavy dirt, use a cloth dipped in a solution of mild detergent and water. Avoid leaving wet objects on the surface or using commercial chemical cleaning products.

Évitez d'exposer le meuble au soleil ou près de toute source de chaleur. Pour le nettoyage, utilisez un chiffon doux et sec. Pour la grosse saleté, utilisez un chiffon humidifié avec un peu de détergent dilué dans l'eau. Évitez de laisser des objets mouillés sur la surface de votre meuble ou d'utiliser des nettoyeurs chimiques.

Evite exponer el mueble al sol o las fuentes de calor. Para limpiarlo, utilice un paño suave y seco. Para limpiar las manchas rebeldes, utilice un trapo húmedo con un poco de detergente diluido en agua. No deje objetos mojados encima del mueble ni utilice limpiadores que contengan productos químicos.

CONGRATULATIONS! YOU ARE NOW THE OWNER OF A QUALITY PRODUCT

FÉLICITATIONS! VOUS AVEZ MAINTENANT EN VOTRE POSSESSION UN PRODUIT DE QUALITÉ
FELICITACIONES! AHORA ES USTED DUEÑO DE UN PRODUCTO DE CALIDAD.

SERVICE/SERVICIO: 1-888 8BESTAR (1-888 823-7827)

Problems and Solutions / Problèmes et solutions / Problemas y Soluciones

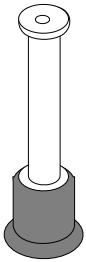

You are at a step of hardware installation and some H-36 are missing:

Before calling to order your missing bolts (H-36), please make sure you have not installed any bolts (H-36) in the wrong place. To remove a bolt (H-36) which is not in the correct place, please refer to your instruction manual.

Vous êtes à une étape d'installation de quincaillerie et il vous manque des H-36 :

Avant d'appeler pour commander des boulons (H-36), assurez-vous de ne pas avoir installé des boulons (H-36) au mauvais endroit. Pour enlever un boulon (H-36) mal situé, consultez le feuillet d'instructions.

Usted está en alguna etapa de la instalación de quincallas y le faltan las H-36 :

Antes de llamar para pedir los pernos (H-36), asegúrese de que no los haya instalado en el lugar equivocado.

Para retirar un perno (H-36) mal puesto, consulte el folleto de instrucciones.

How to separate and install your CO-249 and CO-684 slides:

The CO-249 & CO-684 slides consist of two sections which you must separate. To separate the slides, please refer to your instruction manual. The slides are installed on distinct parts which will be re-grouped only when the drawers are installed on the furniture.

Comment séparer et installer les coulisseaux CO-249 et CO-684 :

Les coulisseaux CO-249 et CO-684 sont constitués d'une partie que vous devez séparer en deux sections. Pour séparer le coulisseau, référez-vous au feuillet d'instructions. Les coulisseaux sont installés sur deux pièces distinctes et seront regroupés seulement lors de l'installation des tiroirs dans le meuble.

Cómo separar y instalar las guías correderas CO-249 y CO-684 :

Las guías correderas CO-249 y CO-684 están constituidas por una parte que usted debe separar en dos secciones. Para separar las guías correderas, consulte el folleto de instrucciones. Las guías correderas se instalan en dos piezas distintas y sólo serán reagrupadas una vez que se instalen los cajones en el mueble.

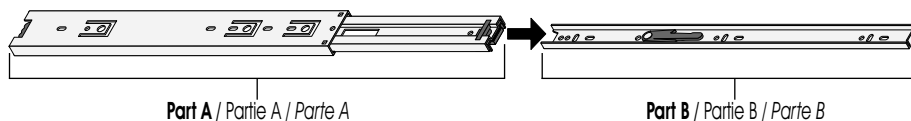

The doors on your furniture are crooked or the space between the doors is uneven:

It is very important to install the hinges and hinge plates on the correct parts while respecting the instruction manual. For the installation and adjustment of the doors, please refer to your instruction manual or log on to the BESTAR internet site (www.bestar.ca).

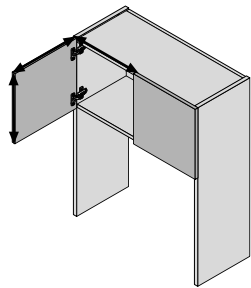

Les portes de votre meuble sont crochues ou l'espace qui les sépare est inégal :

Il est important d'installer les pentures et les plaques sur les bonnes pièces en respectant le feuillet d'instructions. Pour l'installation des portes et leur ajustement, référez-vous à l'étape d'installation des portes dans le feuillet d'instructions ou sur le site internet de BESTAR (www.bestar.ca).

Las puertas de su mueble están chuecas o el espacio que las separa es desigual :

Es importante instalar las bisagras y las placas sobre las piezas adecuadas respetando el folleto de instrucciones. Para la instalación de las puertas y su ajuste, consulte la etapa de instalación de las puertas en el folleto de instrucciones o en el sitio Internet de BESTAR (www.bestar.ca).

The drawers on your furniture are crooked or the space between the drawers is uneven:

While referring to the section indicating the actual sizes of the screws in your instruction manual , please insure that you are using the correct size screws needed when installing your drawer slides and drawer fronts. They must be installed straight. While installing the drawer front, make sure that the correct side is facing up. For the adjustment of the drawer fronts, please refer to your instruction manual or log on to the BESTAR internet site (www.bestar.ca).

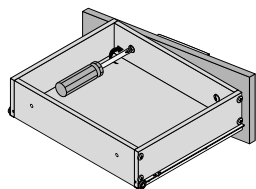

Les tiroirs de votre meuble sont crochues ou l'espace qui les sépare est inégal :

En vous référant au tableau de vis grandeur réelle du feuillet d'instructions, assurez-vous que vous avez utilisé les bonnes vis lors de l'installation des coulisseaux ainsi que du devant de tiroir et qu'elles sont posées bien droites. Assurez-vous également que le devant du tiroir n'est pas assemblé à l'envers. Référez-vous à l'étape d'ajustement des tiroirs dans le feuillet d'instructions ou sur le site internet de BESTAR (www.bestar.ca).

Los cajones de su mueble están chuecos o el espacio que los separa es desigual :

Consulte la tabla de tornillos en tamaño real del folleto de instrucciones y asegúrese de que haya utilizado los tornillos adecuados durante la instalación de las guías correderas así como también la parte delantera del cajón y que éstos estén puestos bien derechos. Asegúrese también de que la parte delantera del cajón no esté ensamblada al revés. Consulte la etapa de ajuste de cajones en el folleto de instrucciones o en el sitio Internet de BESTAR (www.bestar.ca).



For more information or to discover our new products

Pour toute information ou pour découvrir nos nouveaux produits
Para obtener más información o para obtener nuevos productos

www.bestar.ca/site/en/register_your_product
www.bestar.ca/site/fr/enregistrement_de_produit



FOR LONG TIME
POUR LONGTEMPS
POR MUCHO TIEMPO



OUR FURNITURE IS GARANTEED FOR 10 YEARS. NO MATTER THE PROBLEM, OUR CUSTOMER SERVICE IS THERE FOR YOU.

NOS MEUBLES SONT GARANTIS POUR 10 ANS. PEU IMPORTE LE PROBLÈME, N'HÉSITÉZ PAS À COMMUNIQUER AVEC NOTRE SERVICE À LA CLIENTÈLE.

NUESTROS MUEBLES TIENEN UNA GARANTIA DE 10 AÑOS. NO IMPORTA EL PROBLEMA, COMUNIQUE CON NUESTRO SERVICIO A CLIENTE.



BESTAR

The new logo shows an open and radiant person. It also evokes the past of BESTAR, the fact that we were the first manufacturer of ready-to-assemble furniture to design U-Shape furniture. Finally, if you take the logo in its simplest form, it shows that BESTAR is there for its employees, for its customers and for its consumers, "BESTAR is there for you (U)".

Le nouveau logo illustre un personnage ouvert et rayonnant. Il évoque également le passé de BESTAR qui fut le premier fabricant de meubles prêt-à-assembler à concevoir des bureaux en forme de «U». Finalement, si on prend le logo sous sa forme la plus simple, il rappelle que BESTAR est présent pour ses employés, ses clients et ses consommateurs.

El logotipo ilustra un personaje abierto y radiante. Evoca igualmente, el pasado porque Bestar fue el primer fabricante de muebles listos para ensamblar a concebir escritorios en forma de "U". Finalmente, si tomamos el logotipo con su forma la más sencilla, nos recuerda que Bestar está presente para sus empleados, para sus clientes y para sus consumidores. "BESTAR está aquí para USTED (U)".