

Keep this instruction manual for future use.



Division of Shamrock Industries, Inc.  
7001 Wooster Pike  
Medina, OH 44256  
1-877-716-2757 (U.S. Only)  
or 1-330-722-5033



## Duo-SS™ Stroller

Double Side By Side Stroller

### ASSEMBLY & USE INSTRUCTIONS

For use with children  
whose:

**Weight is:**

40 lbs. (18.1 kg)  
or less.

**Height is:**

40 inches (102 cm)  
or less.

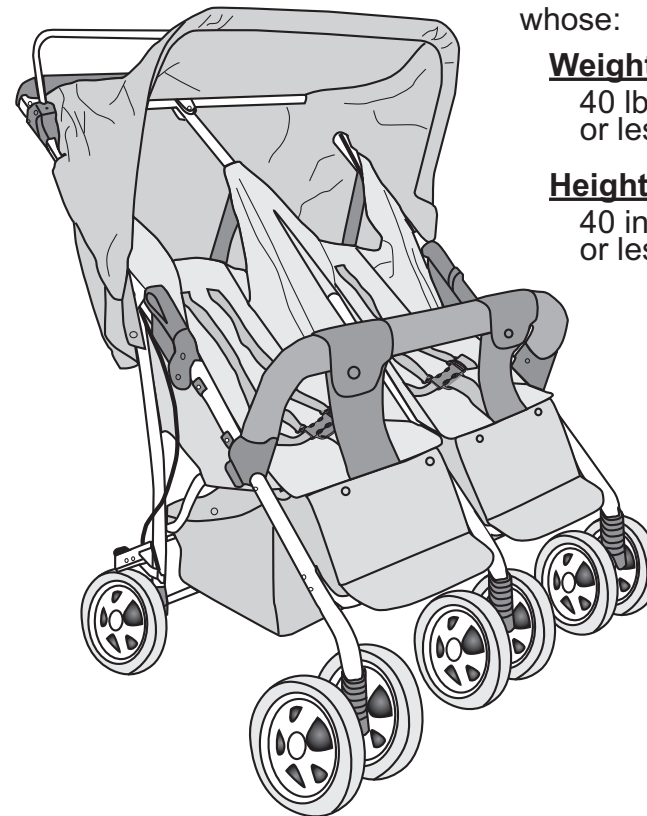

Read all instructions *BEFORE* assembly and *USE* of product  
**KEEP INSTRUCTIONS FOR FUTURE USE.**

## **WARNING**

Failure to follow these warnings and assembly instructions could result in serious injury or death.

### **Avoid Serious Injury To Children From Falling Or Sliding Out:**

- **ALWAYS** use a harness to restrain each child.
- **Snugly** adjust harness around each child.
- **NEVER** leave children unattended, even when sleeping. Always keep children in view.
- **DO NOT** allow children to climb on stroller or stand in seat.

### **Avoid Serious Injury To Children:**

- **DO NOT** allow children to sit or stand in storage baskets.
- **DO NOT** place any child weighing more than 40 lbs. (18.1 kg) or taller than 40 inches (102 cm) in this stroller.
- Use caution when pushing stroller near traffic or in highly congested areas.
- **DO NOT** use stroller on stairs or escalators with children in it.
- **DO NOT** lift stroller by arm bar.

### **Avoid Loss Of Control Of Stroller:**

- **ALWAYS** use front wheel swivel locks when pushing stroller on uneven terrain.
- Use caution when pushing stroller on uneven terrain or hills.
- **ALWAYS** set parking brake when the stroller is stopped.
- **NEVER** leave stroller unattended on a hill or incline even when parking brake is set.

### **Avoid Injury From Stroller Tipping Over:**

- **DO NOT** allow children to climb into stroller unassisted, or to play or hang onto stroller.
- **DO NOT** overload stroller as it can become unstable.
- **DO NOT** carry more than 2 children, one per seat, or place extra parcels or goods in or on the stroller.
- **DO NOT** add package carrying accessories or hang items from stroller
- **DO NOT** place more than 15 lbs. (6.7kg) in each storage basket.
- **ALWAYS** distribute weight as evenly as possible on each side of the stroller.

### **Avoid Pinch Injury:**

- Keep fingers clear of hinged joints when folding and unfolding stroller.
- When making adjustments, always ensure all children's body parts are clear of any moving parts.

## **Assembly Instructions**

- *Adult assembly required. No tools required.*
- Read all instructions before ASSEMBLY and USE of Stroller.
- Unpack carton, remove packing materials, including polybag. Identify and check all parts. If parts are missing or damaged, call Foundations® Consumer Services at 1-877-716-2757 (U.S. Only) or 1-330-722-5033.

## **WARNING**

- **Plastic bags can cause suffocation. Keep plastic bag away from children. Remove and discard plastic bag.**

## **Assembly Assistance**

Foundations® strives for the highest quality in our products but occasionally a missing part or problem can occur during assembly.

If any parts are missing or broken or you need assistance with assembly, **DO NOT** return the product to your dealer. Call Foundations® for assistance at 1-877-716-2757 (U.S. Only) or 1-330-722-5033 (Monday through Friday, 9:00 a.m.– 4:00 p.m. Eastern Time). Please have the Stroller model number and manufacture date located on the stroller frame, near the handle underneath the rear canopy of the stroller available when you call or write us at: Foundations®, 7001 Wooster Pike, Medina, OH 44256.

## Duo-SS™ Stroller Parts

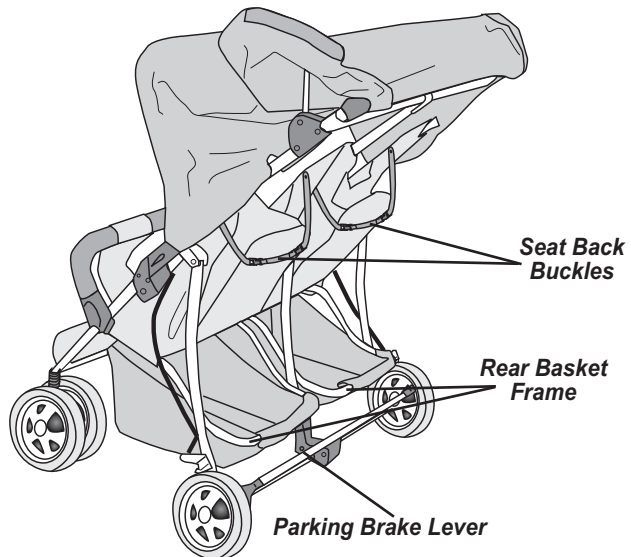
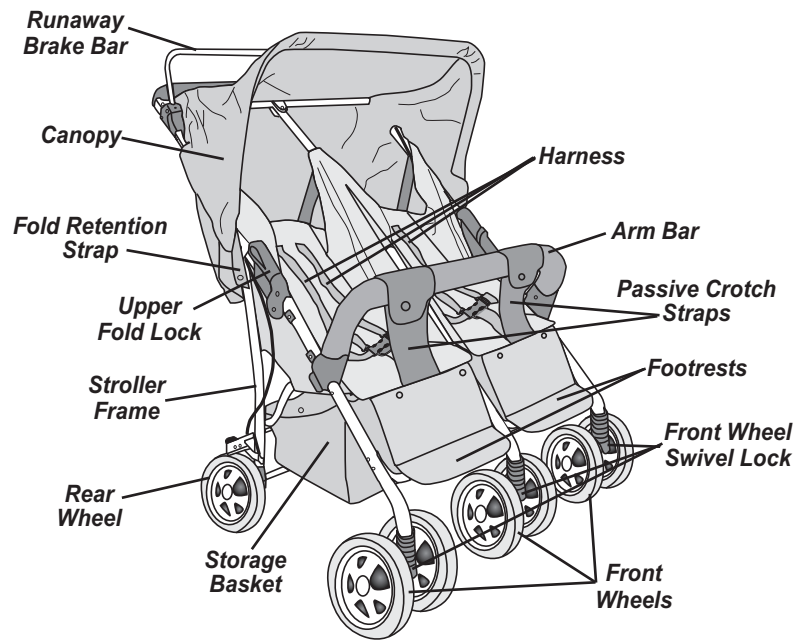

## Parts List

### PARTS LIST

Part Description	Quantity
A. Stroller Frame	1
B. Rear Wheel Assembly	1
C. Front Wheel Assembly	3
D. Arm Bar	1

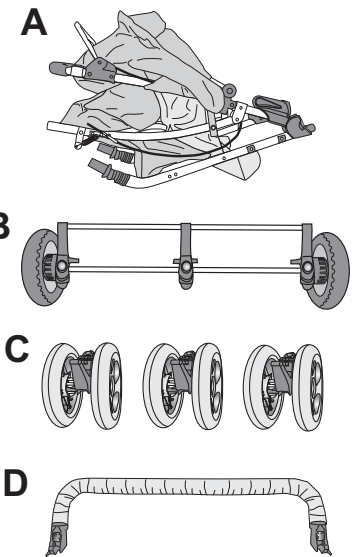

### STEP 1 - Basket Assembly

1. Place folded stroller down on the floor with the footrests facing up.
2. Fold basket fabric over **Basket Tube** and snap in place.

Repeat step 2 to secure fabric to tube on the other side.

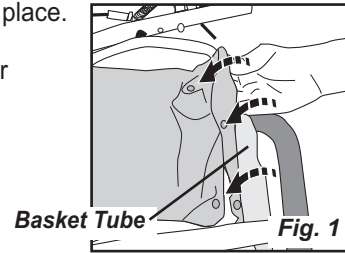

### STEP 2 - Rear Wheel Assembly

1. With parking brake lever facing down and openings in **Rear Wheel Assembly Sleeves** up, align and slide **Rear Wheel Assembly Sleeves** onto leg tubes (**Fig. 1**).
2. After **Rear Wheel Assembly Sleeves** are started onto the rear leg tubes, move parking brake lever down into the locked position.
3. Slide **Rear Wheel Assembly Sleeves** up rear legs until spring button snaps into holes in **Rear Wheel Assembly Sleeves**.

Pull out on **Rear Wheel Axle** to be sure **Rear Wheel Assemblies** are securely snapped to each rear leg.

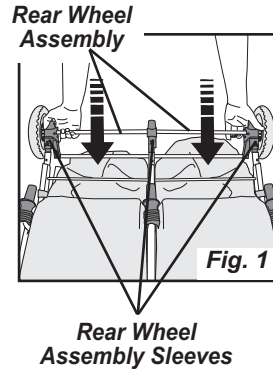

### STEP 3 - Front Wheel Assembly

1. Position front wheel assembly with large opening and swivel lock toward front leg sleeve.
2. Slide **Front Wheel Assembly** onto one of the front leg sleeves (**Fig. 1**).

Pull out on **Front Wheel Assembly** to be sure it is securely snapped to the front leg.

3. Repeat for other **Front Wheel Assemblies**.

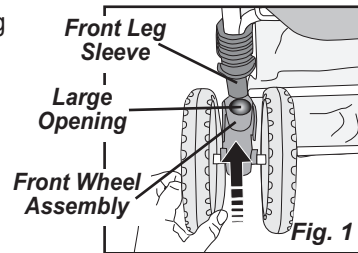

### STEP 4 - Arm Bar Assembly

1. Unfold stroller (see Unfolding Stroller section).
2. Assemble Arm Bar (see Arm Bar Operation section).

### STEP 5 - Securing Canopy Sides

1. Standing at side of stroller, place upper canopy flap down behind runaway brake bracket and side of handle (**Fig. 1**).

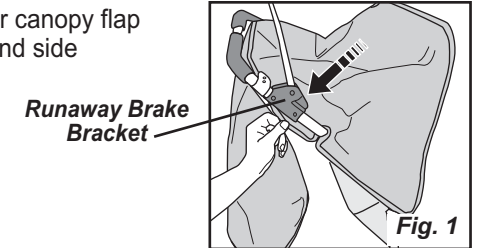

2. Press top and bottom flaps together to secure hook and loop fabric fastener (**Fig. 2**).

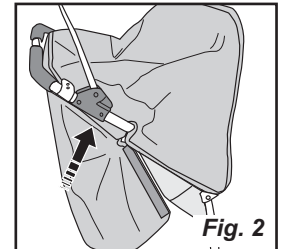

3. Place lower flap over top side of handle (**Fig. 3**).

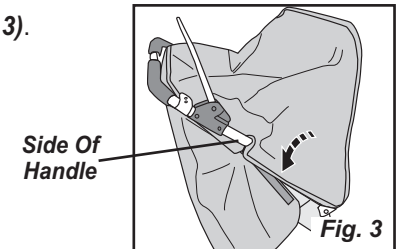

4. Press top and bottom flaps together to secure hook and loop fabric fastener (**Fig. 4**).

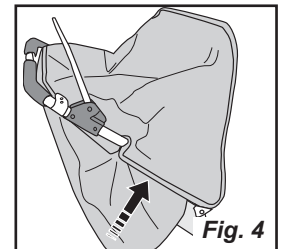

Repeat steps 1 through 4 for opposite side of canopy.

## Unfolding Stroller

### 1. To unfold stroller:

- A. With folded stroller standing up on wheels, locate **Fold Retention Strap**. Press stroller frame together and pull **Fold Retention Strap** off **Pin** on stroller frame (**Fig. 1**).

Repeat on opposite side of stroller.

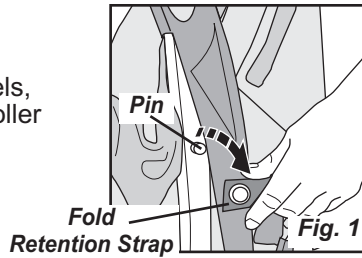

- B. Standing at stroller handle, tip stroller away from you to allow placing your toes under **Rear Basket Frame** and lift up on basket with your toes and snap handle back to lock handle in position (**Fig. 2**).

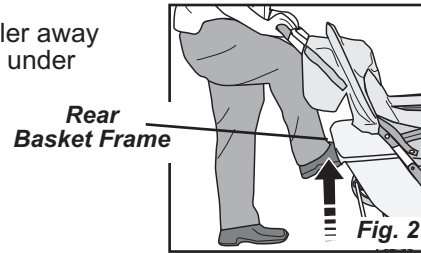

- C. Check to be sure upper fold lock on both sides are down in locked position (**Fig. 3 and Fig. 4**).

The **Upper Fold Lock** MUST slide down and contact the **Lower Fold Lock** with no **Gap** between parts.

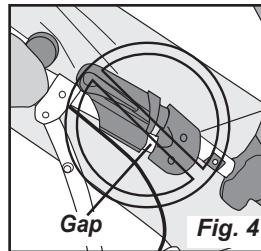
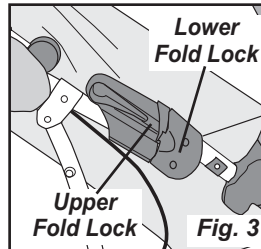

## Folding Stroller

### 1. To fold stroller:

- A. Push parking brake lever down to lock brakes.

- B. Slide **Upper Fold Lock** on both sides up and push down on handle (**Fig. 5 & Fig. 6**).

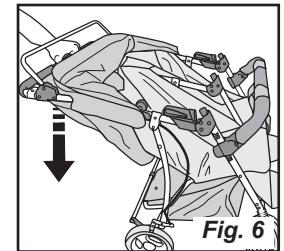
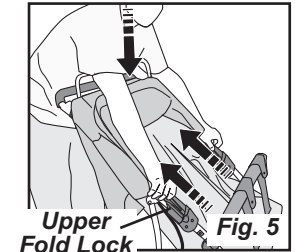

- C. Press folded stroller together and secure with **Fold Retention Strap** by placing **Fold Retention Strap** over **Pin** on stroller frame (**Fig. 7**).

Secure **Fold Retention Strap** on opposite side of stroller.

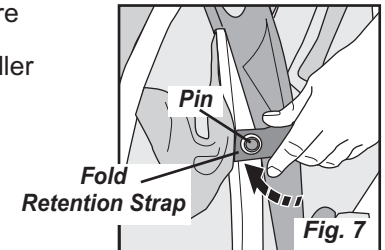

## Stroller Operation & Use

### Securing Children:

# ⚠ WARNING ⚠

#### Avoid Serious Injury To Children From Falling Or Sliding Out:

- **ALWAYS** use a harness to restrain each child.
- **Snugly** adjust harness around each child.
- **NEVER** leave children unattended, even when sleeping. Always keep children in view.
- **DO NOT** allow children to climb on stroller or stand in seat.

1. With harness unbuckled, place child in seat.
2. Secure child with harness by placing **Shoulder and Waist Belts** over shoulders and over thighs. Snap buckle tongues into crotch strap buckle (Fig. 1).
3. Snugly adjust each strap.

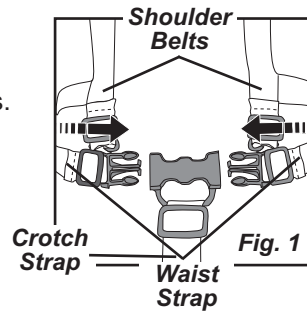

### Harness Adjustment:

*To tighten waist/shoulder belts:*      *To loosen waist/shoulder belts:*

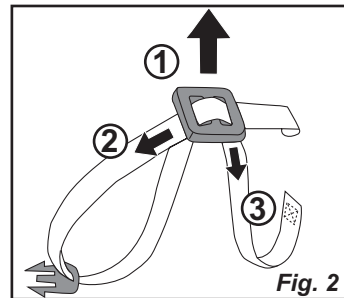
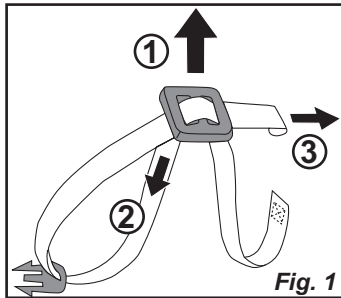

### Crotch Belt Adjustment:

- To tighten crotch belt, slide webbing adjuster down toward seat (**Fig. 3**).
- To loosen crotch belt, slide webbing adjuster up toward buckle (**Fig. 3**).

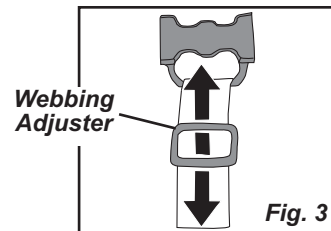

## Stroller Operation & Use (continued)

### Seat Back Recline:

#### To lower seat backs:

1. While holding seat back up, release both **Seat Back Buckles** (**Fig. 1**).
2. Lower seat back into reclined position.

#### To raise seat backs:

1. Push seat back up and forward to upright position, and fasten both **Seat Back Buckles** (**Fig. 1**).

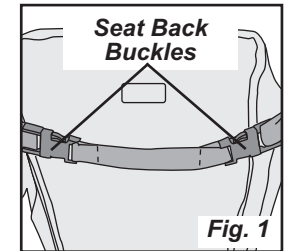

### Front Wheel Swivel Lock Operation:

#### To lock front wheel swivel:

1. Rotate front wheel assembly until it is straight back and swivel lock is aligned with swivel lock track (**Fig. 1**).
2. Push swivel lock up over swivel lock track until it snaps into place.
3. Check that front swivel is securely locked by pushing side to side on front wheel assembly.
4. Repeat steps 1 through 3 for each of the other two (2) front wheel assemblies.

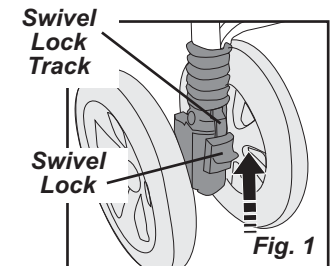

#### To unlock front wheel swivel:

1. Push swivel lock down until it is free of the swivel lock track (**Fig. 2**).
2. Repeat step 1 for each of the other two (2) front wheel assemblies.

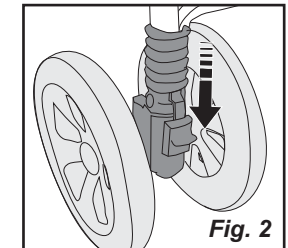

## Stroller Operation & Use (continued)

### Parking Brake Operation:

To lock parking brake:

1. Press down on parking brake lock bar on the rear wheel assembly (**Fig. 1**).
2. Check that both rear wheels are locked.

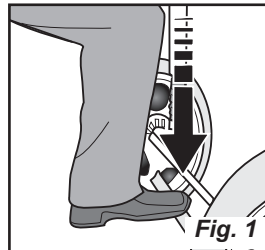

To unlock parking brake:

1. Lift parking brake lock bar up (**Fig. 2**).

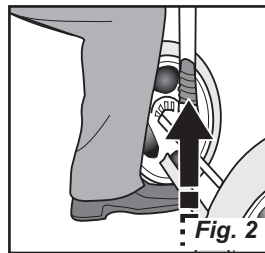

### Runaway Brake Operation:

To release runaway brake:

1. Pull runaway brake bar back and hold runaway brake bar against stroller handle while pushing stroller (**Fig. 3**).

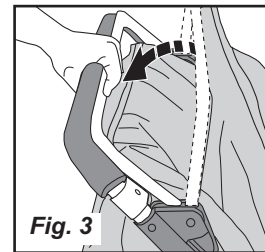

To apply runaway brake:

1. Release runaway brake bar (**Fig. 4**).

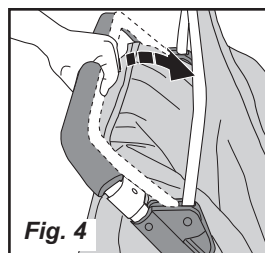

## Stroller Operation & Use (continued)

### Arm Bar Operation:

To remove arm bar:

1. Unfasten snaps on both front passive crotch straps.
2. Pull arm bar clamp out away from stroller to unlock arm bar from stroller frame (**Fig. 1**).
3. Push down and pull out on arm bar to remove it from stroller frame.

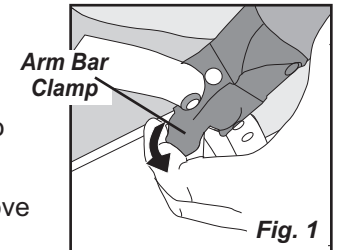

To attach arm bar:

1. Unfold stroller (see Folding and Unfolding Stroller section).
2. With Foundations® logo up, position **Arm Bar Assembly** onto front leg tubes between arm rest stop and stroller seat bottom and snap onto front leg on both sides (**Fig. 1**).

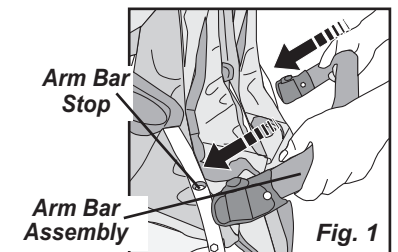

3. Lock Arm Bar to stroller frame by pushing **Arm Bar Clamp** in toward stroller to (**Fig. 2**).

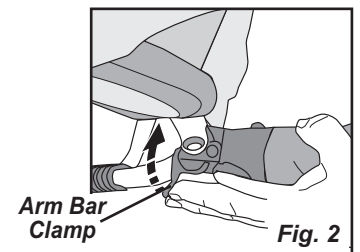

4. Repeat step 3 for opposite end of Arm Bar.

5. Place **Passive Crotch Straps** in center of both seats over Arm Bar and secure snaps (**Fig. 3**).

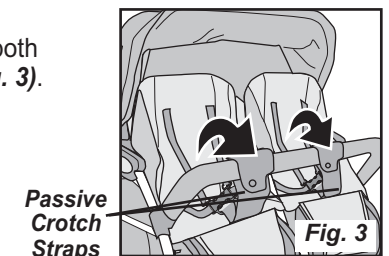

## Stroller Maintenance And Adjustments

### Runaway Brake Operation And Adjustment

Runaway brake should be periodically checked for proper operation.

To check for proper operation of hand brake:

**NOTE:** DO NOT check for proper operation of runaway brake while any children are in stroller.

- Release the brake and push the stroller at a walking pace on a flat level surface.
- While walking, release the stroller handle and hand brake bar.
- The stroller wheels should stop almost immediately without turning, if it does not the runaway brake **MUST** be adjusted. To adjust the runaway brake follow the steps below:

#### To adjust runaway brake:

1. Using an adjustable wrench, loosen the **Jam Nut** on the runaway brake cable adjustment bolt (**Fig. 5**).
2. Using an adjustable wrench, turn the runaway brake **Cable Adjustment Bolt** clockwise to tighten brake or counter-clockwise to loosen brake on that side.
3. While holding runaway brake cable adjustment bolt, use an adjustable wrench to tighten jam nut.
4. Repeat steps 1 through 3 on opposite side of stroller.

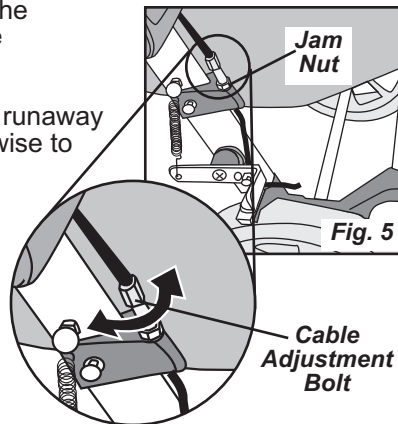

**NOTE:** It is important that both sides are adjusted equally so that the stroller will not turn when runaway brake is applied.

5. Recheck runaway brake for proper operation, see "To Check For Proper Operation Of Runaway Brake" section.
6. If the stroller still does not stop quickly or turns when runaway brake is applied, repeat steps 1 through 5.

**NOTE:** If problems persist call Foundations® for replacement parts or assistance.

## Stroller Maintenance And Adjustments (continued)

### Cleaning seat pad:

- Surface wash small spots with mild solution of soap and water. Do not use bleach.
- Rinse with water to remove soap solution.

### Cleaning stroller:

1. Surface wash stroller frame, plastic parts and fabric with mild solution of soap and water. Do not use bleach. Wipe surfaces with water to remove soap solution.
2. Wipe or air dry.

## One Year Limited Warranty

Foundations® warrants this product to be free from all defects in material and workmanship when used according to the manufacturer's instructions to the original owner for a period of one year from date of purchase. The warranty does not apply to damage caused by product alteration, normal wear and tear, misuse or abuse of the product. Keep your sales receipt as a record of the date of purchase. For replacement parts or warranty issues, please contact Foundations® as we are better able to serve you. **DO NOT** return the product to your retailer or distributor.

If you need assistance, call or write:  
Foundations®, 7001 Wooster Pike, Medina, OH 44256  
Telephone: 1-877-716-2757(U.S. Only) or 1-330-722-5033  
Fax: 1-330-722-5037