

6' MIDTOWN AIR HOCKEY TABLE ASSEMBLY INSTRUCTIONS



NG1037











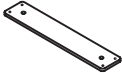

THANK YOU!

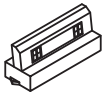
Thank you for purchasing this product.

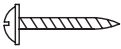
We work around the clock and around the globe to ensure that our products maintain the highest possible quality. However, in the rare instance that your product is defective or missing parts, contact your retailer, or call 800-759-0977, to submit parts requests or warranty claims. Please read the warranty information at the back of these assembly instructions for further details.

**IMPORTANT! PLEASE READ THESE ASSEMBLY INSTRUCTIONS
IN ENTIRETY BEFORE ASSEMBLING YOUR PRODUCT.**

PARTS IDENTIFIER (NOT TO SCALE)

<p>#1</p>  <p>Table Body 1 set</p>	<p>#2</p>  <p>Leg 4 pieces</p>	<p>#3</p>  <p>Leg Base 2 pieces</p>	<p>#4</p>  <p>Leg Panel 4 pieces</p>
<p>#5</p>  <p>Electronics Scorer 1 piece</p>	<p>#6</p>  <p>19MM Washer 12 pieces</p>	<p>#7</p>  <p>4x45MM Washer Head Screw 8 pieces</p>	<p>#8</p>  <p>4x15MM Washer Head Screw 26 pieces</p>
<p>#9</p>  <p>Round Puck 2 pieces</p>	<p>#10</p>  <p>Pusher 2 pieces</p>	<p>#11</p>  <p>Leg Leveler 4 pieces</p>	<p>#12</p>  <p>Allen Tool 1 piece</p>
<p>#13</p>  <p>M8X35MM Bolt 12 pieces</p>			

ADDITIONAL EQUIPMENT REQUIRED:



Please see Parts List at end of manual for part number when ordering parts. For replacement parts please call 800-759-0977.

ASSEMBLY TIPS

1. Find a clean, level surface to begin the assembly of your game table. The table will be partially assembled upside down and then turned over onto its legs. This is a heavy game and turning it over will require at least two strong adults.
2. Remove all of the contents from box and verify that you have all of the parts shown on the Parts Identifier before you begin assembly. **Note: Some parts may be pre-installed or pre-assembled.**
3. Some figures or drawings may not look exactly like your product. Please read and understand the text before beginning each assembly step.
4. **When installing parts that have more than one screw or bolt, hand tighten all screws or bolts in place before finishing tightening with screwdriver or hex wrench.**
5. Electric screwdrivers may be helpful during assembly; however, please set a low torque and use extreme caution because screws may be stripped or overtightened if the electric screwdriver's torque is set too high.

WARNINGS!

READ AND FOLLOW ALL ASSEMBLY, OPERATION AND SAFETY INSTRUCTIONS CAREFULLY.

CHOKER HAZARD - THIS TABLE CONTAINS SMALL BALLS AND PARTS - NOT
SUITABLE FOR CHILDREN UNDER 3 YEARS OF AGE.

ASSEMBLY INSTRUCTIONS

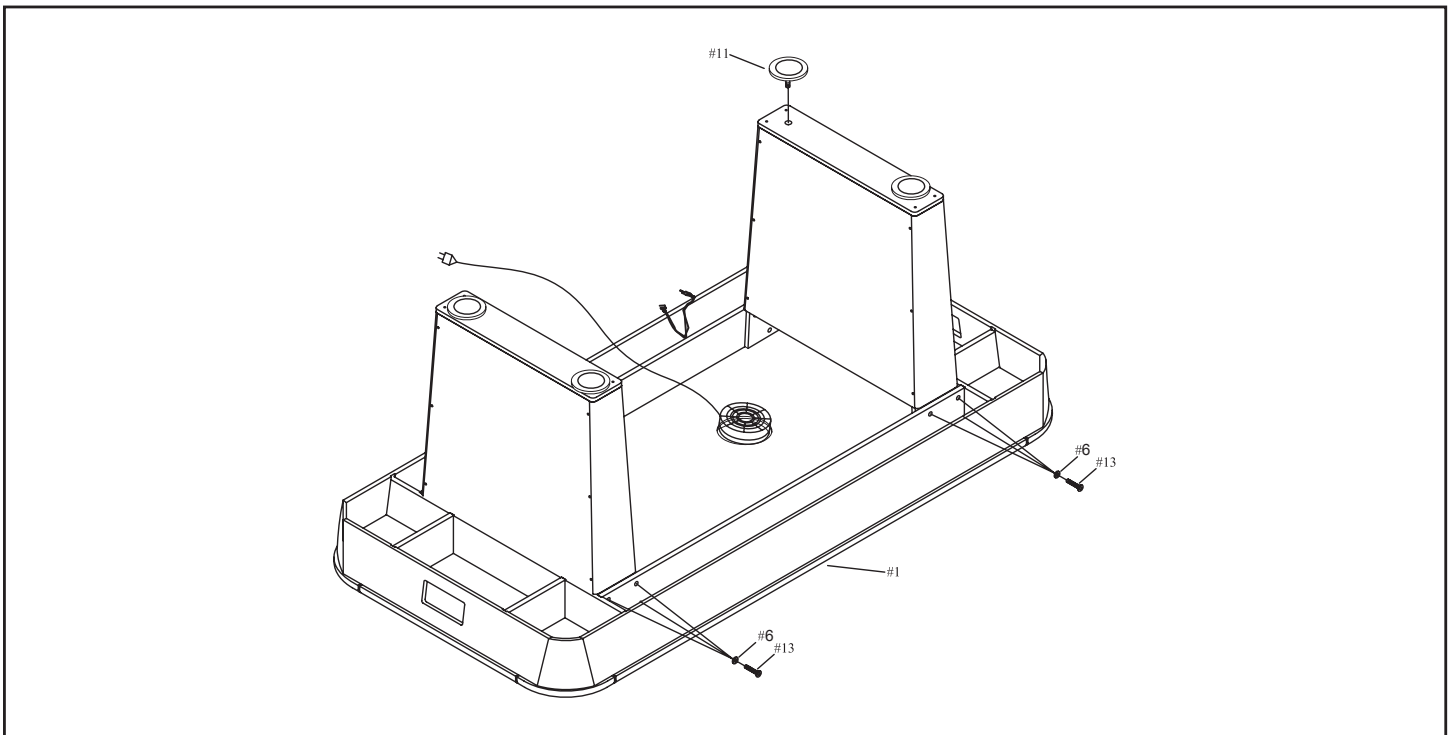
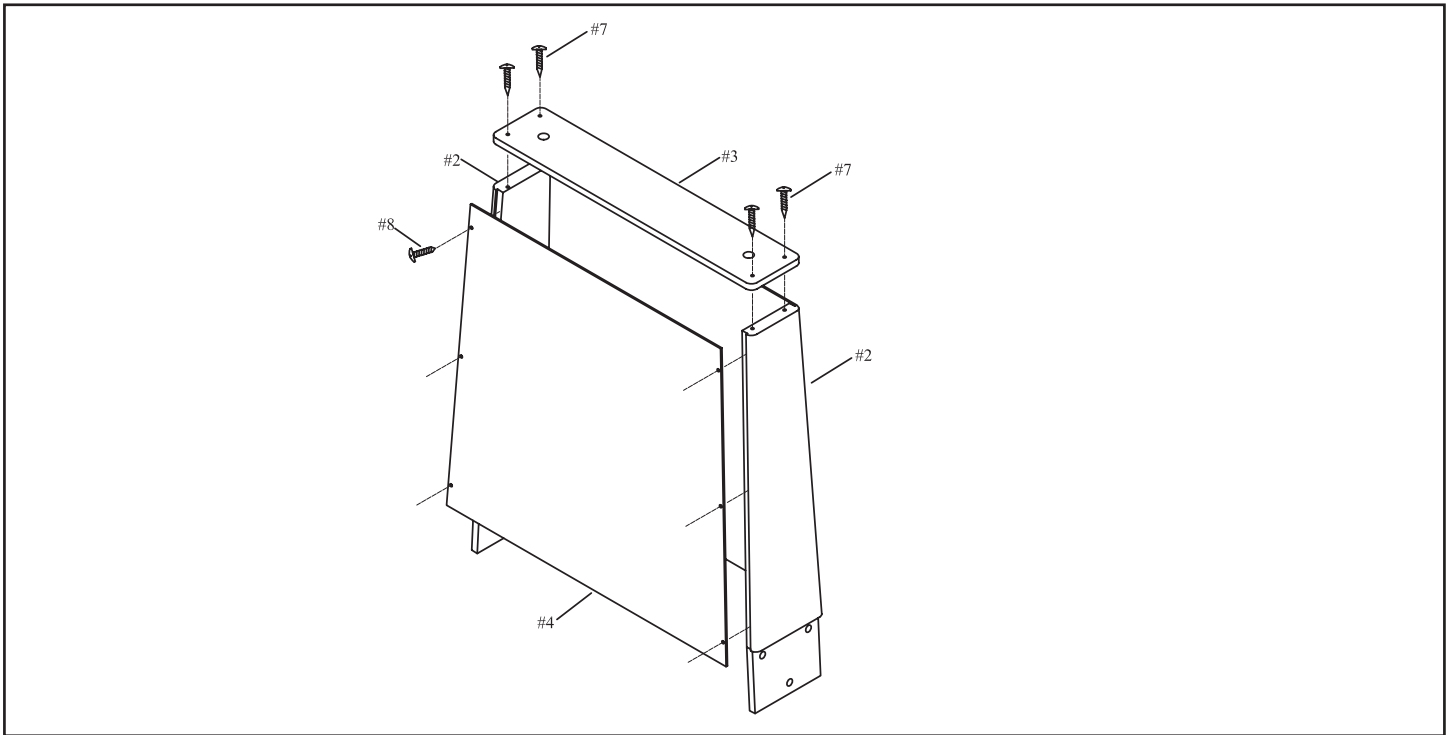

ASSEMBLY INSTRUCTIONS

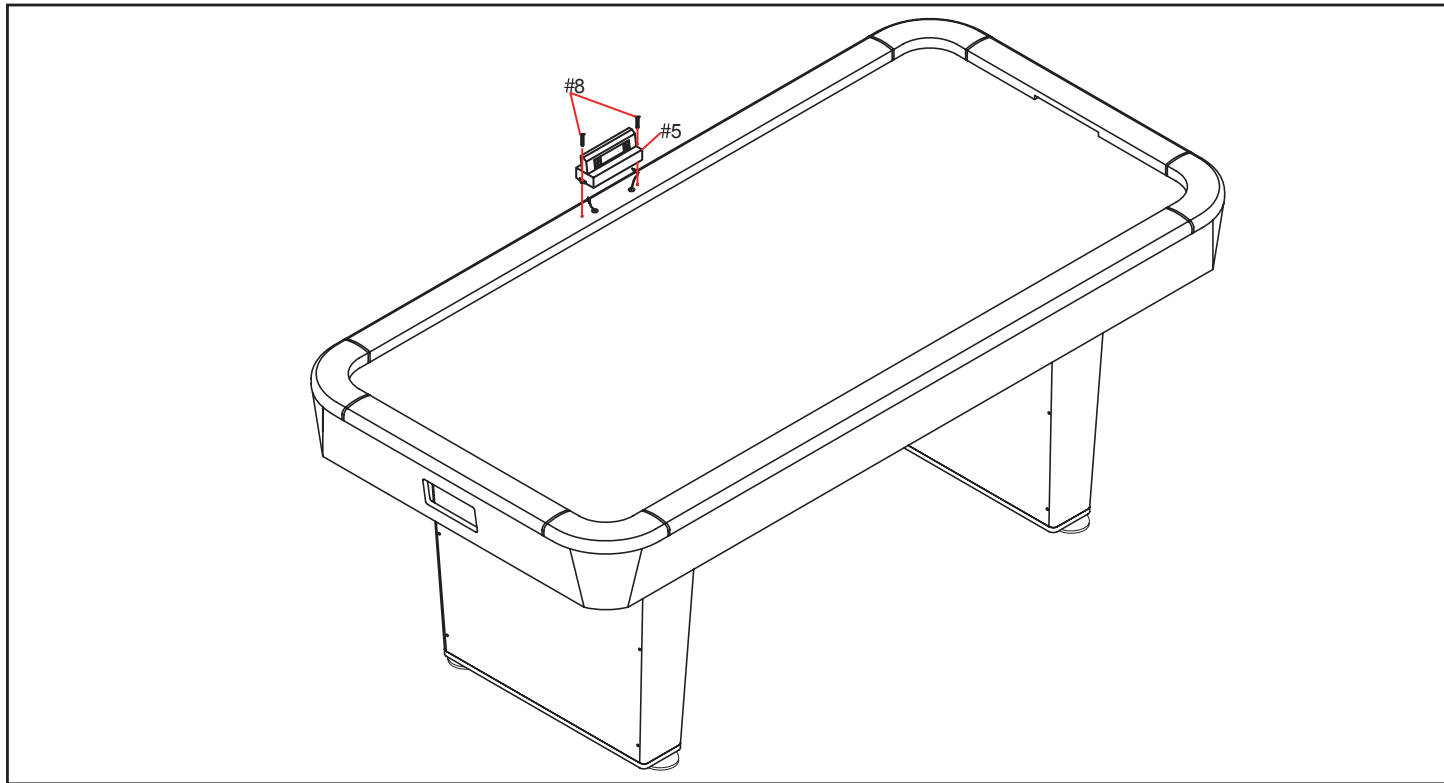

CONGRATULATIONS!

You have now assembled your Game Table. Please note the Care and Use instructions below to ensure years of trouble free use of your game table.

CARE AND USE

1. This product is intended for INDOOR use only.
2. Do NOT sit, climb or lean on the table.
3. Do NOT drag the table when moving it as this will damage the legs.

180-DAY LIMITED WARRANTY

This product is warranted to the original purchaser to be free from defects in material or workmanship for a period of 180 days from the date of the original retail purchase.

This warranty does not cover defects or damage due to improper installation, alteration, accident or any other event beyond the control of the manufacturer. Defects or damage resulting from misuse, abuse or negligence will void this warranty. This warranty does not cover scratching or damage that may result from normal usage.

This product is not intended for institutional or commercial use; the manufacturer does not assume any liability for such use. Institutional or commercial use will void this warranty.

This warranty is nontransferable and is expressly limited to the repair or replacement of the defective product. During the warranty period, the manufacturer shall repair or replace defective parts at no cost to the purchaser. Shipping charges and insurance are not covered and are the responsibility of the purchaser. Labor charges and related expenses for removal, installation or replacement of the product or components are not covered under this warranty.

The manufacturer reserves the right to make substitutions to warranty claims if parts are unavailable or obsolete.

The manufacturer shall not be liable for loss of use of the product or other consequential or incidental costs, expenses or damages incurred by the consumer of any other use. The user assumes all risk of injury resulting from the use of this product.

This warranty is expressly in lieu of all other warranties, expressed or implied, including warranties of merchantability or fitness for use to the extent permitted by Federal or state law. Neither the manufacturer nor any of its representatives assumes any other liability in connection with this product.

All warranty claims must be made through the retailer where the product was originally purchased. A purchase receipt or other proof of date of purchase will be required to process all warranty claims. The model number and part numbers found within the assembly instructions will be required when submitting any parts requests or warranty claims.







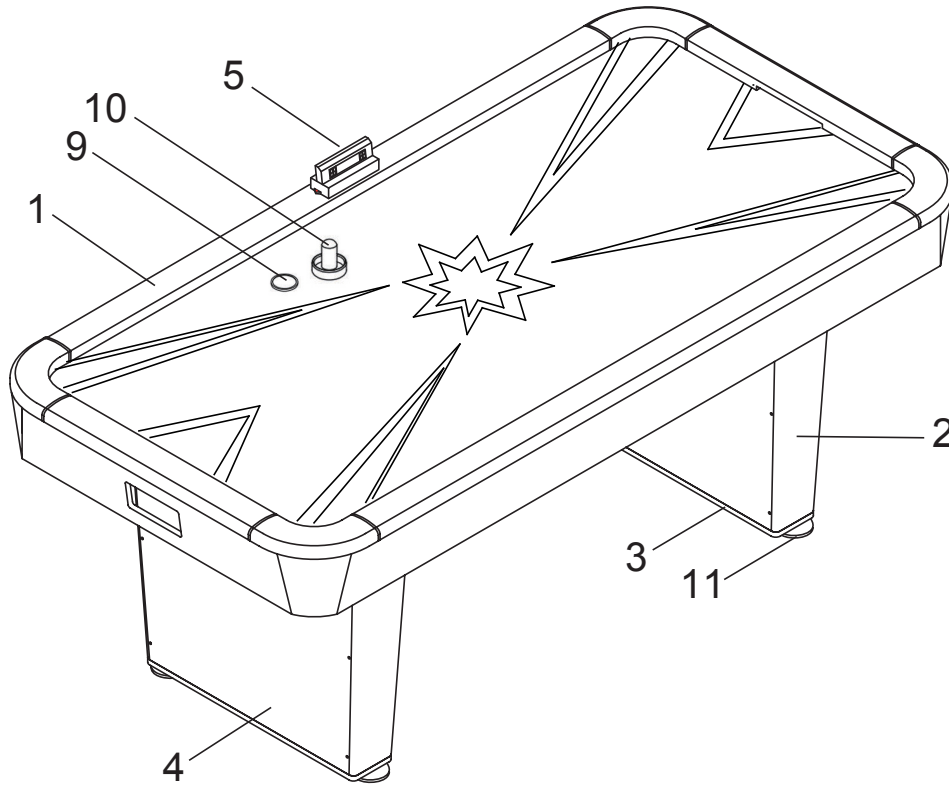

For further warranty information or inquiries, please call 800-759-0977

6' MIDTOWN AIR HOCKEY TABLE - NG1037





Parts List



PARTS

<p>#1 NGP5841</p>  <p>TABLE BODY</p>	<p>#2 NGP5842</p>  <p>LEG</p>	<p>#3 NGP5843</p>  <p>LEG BASE</p>	<p>#4 NGP5844</p>  <p>LEG PANEL</p>	<p>#5 NGP5845</p>  <p>ELECTRONIC SCORER</p>	<p>#9 NGP5774</p>  <p>PUCK</p>	<p>#10 NGP5773</p>  <p>STRIKER</p>
<p>#11 NGP5848</p>  <p>LEG LEVELER</p>	<p>NGP5889 <i>Part of Table Body</i></p>  <p>BLOWER MOTOR</p>					

HARDWARE PACK - NGP5846

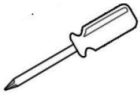
<p>#6</p>  <p>FLAT WASHER</p>	<p>#7</p>  <p>1-3/4" SCREW</p>	<p>#8</p>  <p>5/8" SCREW</p>	<p>#12</p>  <p>HEX WRENCH</p>	<p>#13</p>  <p>BOLTS</p>	<p>ADDITIONAL EQUIPMENT REQUIRED:</p>  <p>PHILLIPS HEAD SCREWDRIVER</p>
--	---	---	--	--	--