

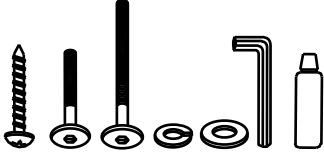

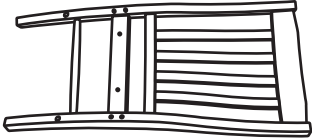



Assembly Instructions

DS452S / DQ1452S RAKE BACK SIDE CHAIR

PARTS LIST



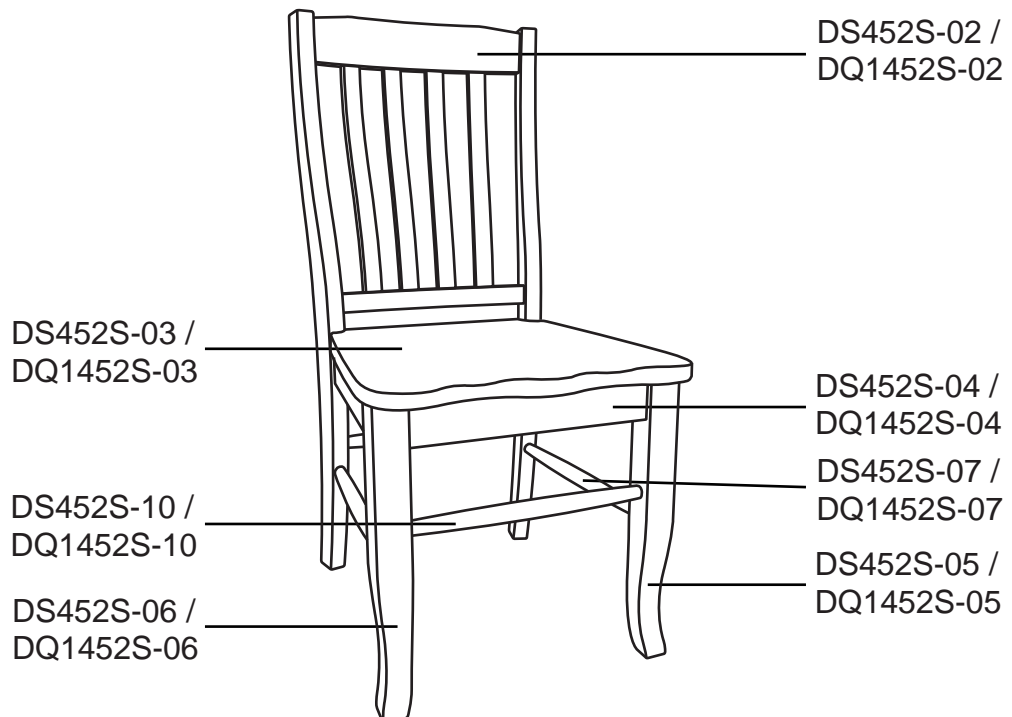



PART NO	FIGURE	DESCRIPTION	Q'TY
DS452S-01 / DQ1452S-01		Hardware Bag	1 Pce
DS452S-02 / DQ1452S-02		Chair Back	1 Pce
DS452S-03 / DQ1452S-03		Wood Seat	1 Pce
DS452S-04 / DQ1452S-04		Seat Frame	1 Pce
DS452S-05 / DQ1452S-05		Front Leg (Right)	1 Pce
DS452S-06 / DQ1452S-06		Front Leg (Left)	1 Pce
DS452S-10 / DQ1452S-10		Front Stretcher (Short)	1 Pce
DS452S-07 / DQ1452S-07		Side Stretcher (L/R-Long)	2 Pcs



Assembly Instructions

DS452S / DQ1452S RAKE BACK SIDE CHAIR

Hardware List :

						
8x1.1/4" Pan Head Screw 6 pcs	M6x40mm JCBC Bolt 2 pcs	M6x70mm JCBC Bolt 8 pcs	M6x13mm Lock Washer 10 pcs	M6.5x16.5mm Flat Washer 10 pcs	Allen Key 1 pce	Glue 1 pce

ASSEMBLY:

- Position the Chair Back on a soft surface such as a carpet. Place the Box System Assembly (Wood seat is pre-attached to the seat frame in assembly) on to the middle rail of the Chair Back with the dowel fully inserted into the pre-drilled hole.
 - 1.1. Insert 70mm JCBC Bolt through a Lock Washer and a Flat Washer into the pre-drilled holes on the rear corner block of the seat frame.
 - 1.2. Insert the 40mm JCBC Bolt through a Lock Washer and a Flat Washer through the rear pre-drilled holes on the seat frame.
- Apply Glue to all the pre-drilled holes before attaching all Stretchers. Insert each Side Stretcher into pre-drilled holes on both of the Rear Legs, make sure that screw hole on the Stretcher are facing down. Insert the Front Stretcher into the pre-drilled holes on the Front Legs. Place the assembled Front Legs to Corner Block of the frame, and insert Side Stretcher into the Legs.
 - 2.1. Insert the 70mm JCBC Bolt through a Lock Washer, a Flat Washer and the pre-drilled holes of Corner Block into the pre-drilled holes on the Front Leg, use the provided Allen Key. But do not fully tighten the bolts yet.
 - 2.2. Insert Pan Head Screw into Front Stretcher and Side Stretcher through the pre-drilled holes, tighten with screw-driver.

(STEP 1)

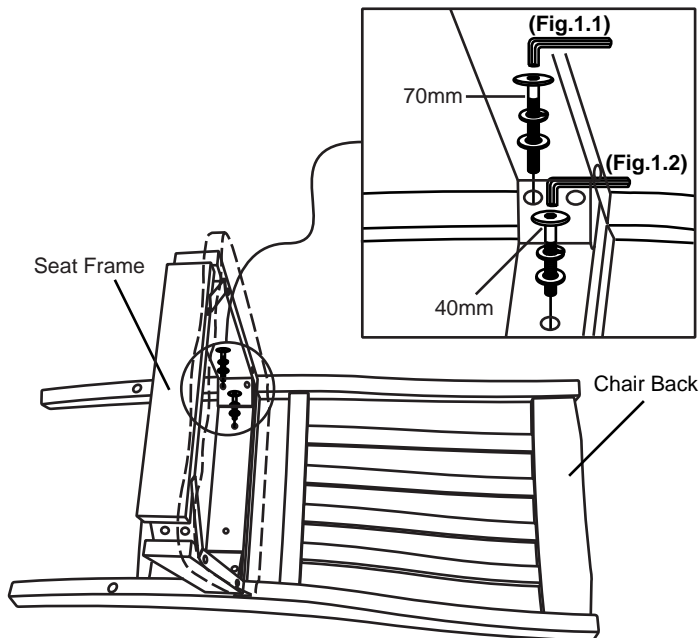

(STEP 2)

Apply Glue and insert stretcher with screw holes facing down.

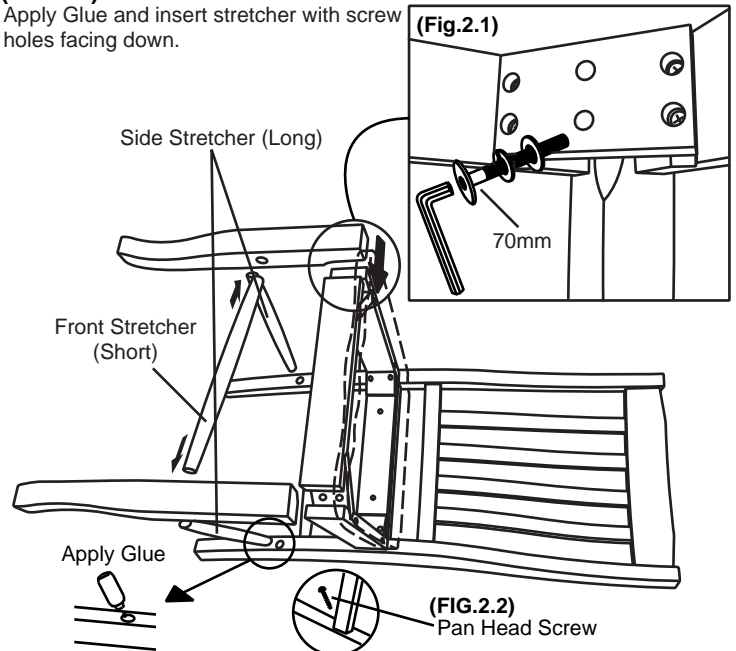

(STEP 3)

Turn the chair to standing position. Check its balance and tighten all screw and bolts to complete the assembly.

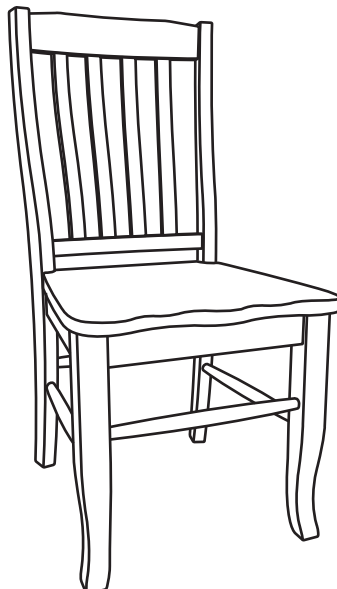

CARE INSTRUCTION

- ~ Be sure to use the same type of polish consistently. Your furniture will appear cloudy or streaky if oil based or wax based polishes are interchanged.
- ~ Spray your furniture surface evenly. Wipe in a circular motion with a soft clean cloth.