

Outdoor Fire Pit

Owner's Manual

Square Fire Pit, Item #60454



Table of Contents:

Warning.....	Page 2
Parts List.....	Page 3
Assembly.....	Page 4
Operating Instructions.....	Page 5
Cleaning and Care.....	Page 6
Storage.....	Page 6
Warranty Information.....	Page 7

****IMPORTANT NOTICE****

Do **NOT** return to place of purchase. For customer Service and warranty issues, please contact our **TOLL FREE HOTLINE: 866-985-7877** or Email: cservice@welltraveled.net.
Hotline hours: Mon – Fri, 9AM to 6PM, EST

SAVE THESE INSTRUCTIONS FOR FUTURE REFERENCE.

Outdoor Fire Pit

Owner's Manual

Square Fire Pit, Item #60454



WARNING: FOR YOUR SAFETY

1. This appliance is for outdoor use only and should NOT be used in a building, garage, or any other enclosed area.
2. Do NOT use this outdoor fire pit for indoor heating. TOXIC carbon monoxide fumes can accumulate and cause asphyxiation.
3. This outdoor fire pit is NOT recommended for commercial use.
4. This outdoor fire pit is NOT to be operated by children.
5. This outdoor fire pit is NOT to be used in or on boats or recreational vehicles.
6. Always use in accordance with all applicable local, state, and national codes. Contact your local fire department for details on outdoor burning.
7. When using this outdoor fire pit, exercise the same precautions you would with any open fire.
8. The use of alcohol, prescription or non-prescription drugs may impair the consumer's ability to properly assemble or safely operate this outdoor fire pit.
9. Do NOT use this outdoor fire pit without reading this "Owner's Manual."
10. This outdoor fire pit is for use with dry, seasoned hardwood. It will burn hotter, more completely and create less smoke.
11. Do NOT burn charcoal briquets, lump charcoal, manufactured logs, driftwood, trash, leaves, paper, cardboard, plywood, painted or stained or pressure treated wood. Avoid using soft woods such as pine or cedar that can throw sparks.
12. Do NOT alter this outdoor fire pit in any manner.
13. Do NOT use this outdoor fire pit until it is completely assembled.
14. Do NOT store or use gasoline or other flammable vapors or liquids in the vicinity of this or any other appliance.
15. Do NOT store or use an LPG cylinder within 10 feet of this outdoor fire pit while it is in operation.
16. Do NOT use this outdoor fire pit near automobiles, trucks, vans or recreational vehicles.
17. Do NOT use in an explosive atmosphere. Keep outdoor fire pit area clear and free from combustible materials, gasoline and other flammable liquids.
18. Do NOT use this outdoor fire pit under any overhang or near any unprotected combustible constructions. Avoid using near or under any overhanging trees or shrubs.
19. Always empty this outdoor fire pit before each use once the fire pit has cooled COMPLETELY. Leave a thin layer of ash to protect the bottom of the firebowl.
20. Do NOT wear flammable or loose clothing when operating this fire pit.

21. Do NOT use in windy conditions.
22. Do NOT use this outdoor fire pit unless the spark guard/firescreen is securely in place.
23. Do NOT use gasoline, kerosene, diesel fuel, lighter fluid or alcohol to light or re-light fires.
24. Keep all electrical cords away from a hot fire pit.
25. All surfaces of this outdoor fire pit are hot when in operation. To avoid burns, do NOT touch any part of the fire pit until it has cooled completely. Use the fire tool provided and wear protective gear (i.e. potholders, gloves, BBQ mittens, hot pads, etc.) to handle any parts. NEVER touch ashes or coals to see if they are hot.
26. Do NOT leave a lit outdoor fire pit unattended, especially around children and pets.
27. Do NOT attempt to move or store this outdoor fire pit until all ashes and coals are completely extinguished.
28. Do NOT remove ashes or coals until they are completely and fully extinguished.
29. Use heat resistant gloves or hot pads when touching any surfaces of the fire pit.
30. Only use the fire tool provided to add or move logs.
31. Do NOT place wood directly into bottom of the outdoor fire pit. Place wood only on the LOG grate. **(IF GRATE IS INCLUDED.)**
32. Do NOT overload the fire pit. Do not add additional firewood until the fire burns down. NOTE: If any portion of the bowl, lid or spark guard/firescreen of this outdoor fire pit are glowing, your fire is TOO BIG and the fire pit is overloaded.
33. Do NOT lean over this outdoor fire pit when lighting or while in use.
34. Do NOT place a hot spark guard/firescreen or hot fire tool onto a combustible surface such as grass, wood or furniture.
35. Avoid breathing smoke from the fire and avoid getting it into your eyes.
36. This outdoor fire pit should be thoroughly inspected and cleaned on a regular basis.
37. After a period of storage and/or non-use, check for signs of damage and creosote build-up. Do NOT operate until necessary repairs and/or clean up are executed.
38. Death, serious injury or property damage may occur if the above is not followed exactly.

CAUTION: It is not recommended to use this fire pit on a wooden or other combustible surface or any surface that is not entirely resistant to high heat. However, if you intend to use this item on a wooden deck or other combustible surface, or any surface that is not entirely resistant to high heat, you MUST use a non-flammable and heat resistant material such as concrete pavers, brick, or stone between the fire pit and the surface.







Outdoor Fire Pit

Owner's Manual

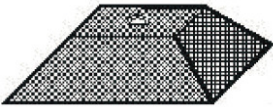
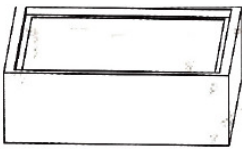
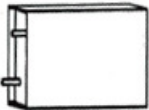
Square Fire Pit, Item #60454



PARTS LIST

Part Number	Quantity	Description	Picture
A	1	Fire Screen	
B	1	Fire Bowl	
C	4	Leg	
D	1	Lift Tool	
E	10	Nut	
F	1	Handle	
G	1	Steel Plate	
H	2	Bolt	

Outdoor Fire Pit

Owner's Manual

Square Fire Pit, Item #60454



Assembly

For easiest assembly:

**Locate all parts first, then assemble on a flat, level surface. Make sure the assembly area is large enough to lay out all parts required for assembly.

**Follow all steps listed to make sure assembly is complete.

STEP 1:

Attach Leg (C) to Fire Bowl (B) using 2 Nuts (E). For best results, make sure that seam on Leg is facing the inside of the Fire Bowl (see figure to the right)—repeat to attach all 4 Legs.

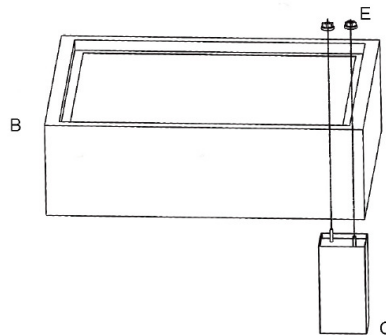

STEP 2:

Place Handle (F) on top of the Fire Screen (A) and put 2 Bolts (H) through holes on Handle and through Fire Screen. Attach Steel Plate (G) on underside of Fire Screen and tighten 2 Nuts (E) onto ends of the Bolts.

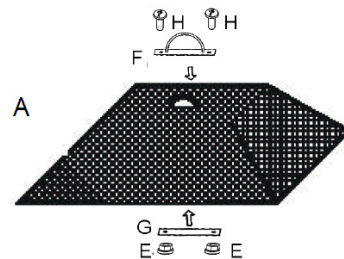

STEP 3

Place Fire Screen on top of assembled Fire Bowl/ Legs. NOTE: ALWAYS use Lift Tool (D) to remove/replace Fire Screen.

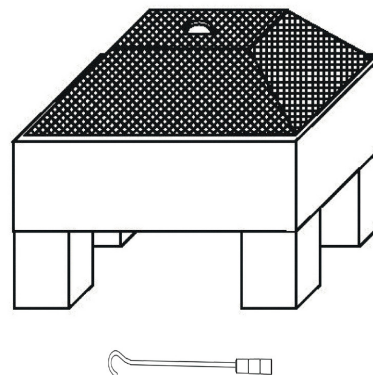

Outdoor Fire Pit

Owner's Manual

Square Fire Pit, Item #60454



WARNING



FOR YOUR SAFETY:

Before using this outdoor fire pit, make sure you have read, understand, and are following all of the **WARNINGS** as given on Page 2 of this manual. Failure to follow all instructions and **WARNINGS** can cause property damage, serious personal injury or death.

Operating Instructions

Lighting

1. Place a layer of dry kindling or a natural fire starter such as Fatwood™ onto the center of the fire bowl.
2. Place a layer of dry seasoned hardwood on top of the kindling. Make sure the hardwood is cut in lengths no more than $\frac{3}{4}$ the diameter of the fire bowl.
3. Use a long match or stick lighter to light the kindling or firestarter.
4. Place the Spark Guard/Firescreen on the bowl by using the Fire Tool provided once the kindling or firestarter is lit.

Tending the Fire

You may need to shift and/or add logs for the best fire.

REMINDERS

- **Always wear protective gloves or use a pot holder when tending a fire.
 - **Wait until glowing coals have developed before adding any additional wood.
 - **Do NOT add gasoline, kerosene, diesel fuel, lighter fluid or alcohol to relight or enhance an existing fire.
1. Carefully remove the Spark Guard/Firescreen by using the Fire Tool provided.
 2. While using the long handled Fire Tool, shift coals and logs to allow additional airflow.
 3. If additional wood is required, place wood on top of coals. Be careful not to shift ashes.
 4. Replace Spark Guard/Firescreen by using the Fire Tool provided.

Extinguishing the Fire

1. Allow the fire to burn itself out.
2. Do NOT use water to extinguish a fire as this is dangerous and can cause damage to the outdoor fire pit.

FireSense® products are made to resist premature rusting. However, eventually, all metals will rust. Some environments promote premature rusting of metals. For best results, at the first sign of rust or other corrosion, use an emery cloth, metal-grade sand paper or a rotary tool to buff away the blemish and touch up the spot with rust-resistant spray paint available at local hardware stores.

Outdoor Fire Pit

Owner's Manual

Square Fire Pit, Item #60454



Cleaning and Care

Inspecting:

This outdoor fire pit should be inspected on a regular basis to ensure product safety and longer product life.

Do NOT attempt to inspect this outdoor fire pit until the fire is COMPLETELY out and fire pit is COOLED COMPLETELY.

1. Check handle on Spark Guard/Firescreen to make sure it is secure.
2. Check all parts for signs of damage or rust.
3. If you find any damaged parts, do NOT operate until repairs and/or replacement has been done.

Cleaning

This outdoor fire pit should be cleaned on a regular basis to promote a safer experience and longer product life.

NOTE: After repeated use, a slight discoloration of the finish may occur.

Do NOT attempt to clean this outdoor fire pit until the fire is COMPLETELY out and the fire pit has cooled completely.

Do NOT use oven cleaner or abrasive cleaners as they will damage this product.

Do NOT clean any part of this outdoor fire pit in a self cleaning oven as it may damage the finish.

1. Wipe exterior surfaces with a mild dishwashing detergent or baking soda.
2. For stubborn surfaces, use a citrus based degreaser and a nylon scrubbing brush.
3. Rinse with clean water.
4. Remove built-up creosote from components with a chimney cleaning product.

Storage

Do NOT move or store this outdoor fire pit until the fire is COMPLETELY out and the fire pit has cooled COMPLETELY.

1. Once the fire is out, coals are cold and outdoor fire pit is cool to the touch, remove ashes and dispose of properly.
2. It is best to cover the outdoor fire pit with a protective vinyl cover. DO NOT cover fire pit until it has COMPLETELY cooled.
3. Store assembled in a location away from children and pets.

NOTE: If you do not use a protective vinyl cover, store this outdoor fire pit in a dry location to maximize product life.

Distributed By:
Well Traveled Living
716 S 8th Street
Amelia Island, FL 32034
Toll Free: 866-WTL-SUPP



Web: www.wtliving.com
Email: cservice@welltraveled.net

1 YEAR LIMITED WARRANTY – Customers in the Continental US

All components are warranted for a period of 1 year after date of purchase by the original owner against defects in materials and workmanship under normal use. This warranty does NOT cover normal wear and weathering, assembly and/or maintenance OR use in a commercial application. At Well Traveled Living's sole discretion, products under warranty will be repaired and/or replaced at no charge to the customer. Any returns sent back to Well Traveled Living must be sent via prepaid freight and in the original retail packaging.

For warranty service contact Well Traveled Living at the address, phone numbers or internet site and email listed in this owner's manual. Be sure to have your sales receipt, date of purchase and catalogue/model numbers available when calling. All warranty service will be coordinated by the Well Traveled Living's, Amelia Island, Florida service center.

This warranty is extended only to the original purchaser. Proof of purchase will be required before warranty service is rendered. The sales receipt is the only valid proof of purchase. This warranty only covers failures due to defects in materials or workmanship which occur during normal use. Failures and/or damage which result from accident, negligence, misuse, abuse, neglect, mishandling, alteration or modification, failure to maintain, improper assembly or maintenance, service by unauthorized agency or use of unauthorized components or damage that is attributable to acts of God are NOT covered.

*****THERE ARE NO EXPRESS WARRANTIES EXCEPT AS LISTED ABOVE*****

*****PURCHASER ASSUMES ALL RISKS IN THE ASSEMBLY AND OPERATION OF THIS UNIT*****

*****FAILURE TO FOLLOW WARNINGS AND OPERATIONAL INSTRUCTIONS CONTAINED IN THIS MANUAL CAN RESULT IN SEVERE PROPERTY DAMAGE AND/OR PERSONAL INJURY*****

IN NO EVENT WILL WELL TRAVELED LIVING, OR ITS DIRECTORS, OFFICERS OR AGENTS BE LIABLE TO THE PURCHASER OR ANY THIRD PARTY, WHETHER IN CONTRACT, IN TORT, OR ON ANY OTHER BASIS, FOR ANY INDIRECT, SPECIAL, PUNITIVE, EXEMPLARY, CONSEQUENTIAL, OR INCIDENTAL LOSS, COST, OR DAMAGE ARISING OUT OF OR IN CONNECTION WITH THE SALE, MAINTENANCE, USE, OR INABILITY TO USE THE PRODUCT, EVEN IF WELL TRAVELED LIVING OR ITS DIRECTORS, OFFICERS OR AGENTS HAVE BEEN ADVISED OF THE POSSIBILITY OF SUCH LOSSES, COSTS OR DAMAGES, OR IF SUCH LOSSES, COSTS, OR DAMAGES ARE FORESEEABLE. IN NO EVENT WILL WELL TRAVELED LIVING, OR ITS OFFICERS, DIRECTORS, OR AGENTS BE LIABLE FOR ANY DIRECT LOSSES, COSTS OR DAMAGES THAT EXCEED THE PURCHASE PRICE OF THE PRODUCT.

SOME JURISDICTIONS DO NOT ALLOW THE EXCLUSION OR LIMITATION OF INCIDENTAL OR CONSEQUENTIAL DAMAGES, SO THE ABOVE LIMITATION OR EXCLUSION MAY NOT APPLY TO THE PURCHASER.

This limited warranty gives you specific legal rights and you may also have other rights which vary from jurisdiction to jurisdiction. The provisions of the United Nations Convention on Contracts for the Sales of Goods shall not apply to this limited warranty or the sale of products covered by this limited warranty.

*****IMPORTANT NOTICE*****

-Do **NOT** return to place of purchase-
For customer service and warranty issues
contact our Customer Service Center at:
(866)-985-7877 OR

Email: cservice@welltraveled.net

Customer Service Hours: Mon. – Fri. 9:00 a.m. – 6:00 p.m. (EST)