

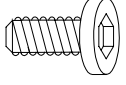







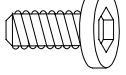

Components and Hardware List

<p>M1/4" X 5/8" Allen Head Bolt</p>  <p>A 8 pcs.</p>	<p>1/4" Spring Washer</p>  <p>B 8 pcs.</p>	<p>1/4" x 16mm Large Flat Washer</p>  <p>C 8 pcs.</p>	<p>4mm Allen Wrench</p>  <p>D 1 pc.</p>
<p>M1/4" X 5/16" Allen Head Bolt</p>  <p>E 8 pcs.</p>	<p>1/4" x 14mm Small Flat Washer</p>  <p>F 8 pcs.</p>	<p>Top</p>  <p>G 1 pc.</p>	<p>Stretcher Tube</p>  <p>H 2 pcs.</p>
<p>Leg Assembly</p>  <p>I 2 pcs.</p>	<p>Middle Shelf</p>  <p>J 1 pc.</p>	<p>Anti-Tip Restraint Set</p>  <p>K 1 pc.</p>	

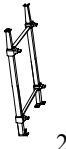

66515 Sofa Table

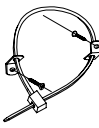
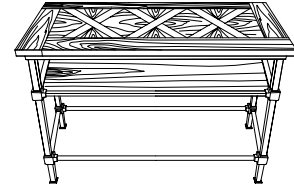
Be sure to check all packing material carefully for small parts, which may have come loose inside the carton during shipment.

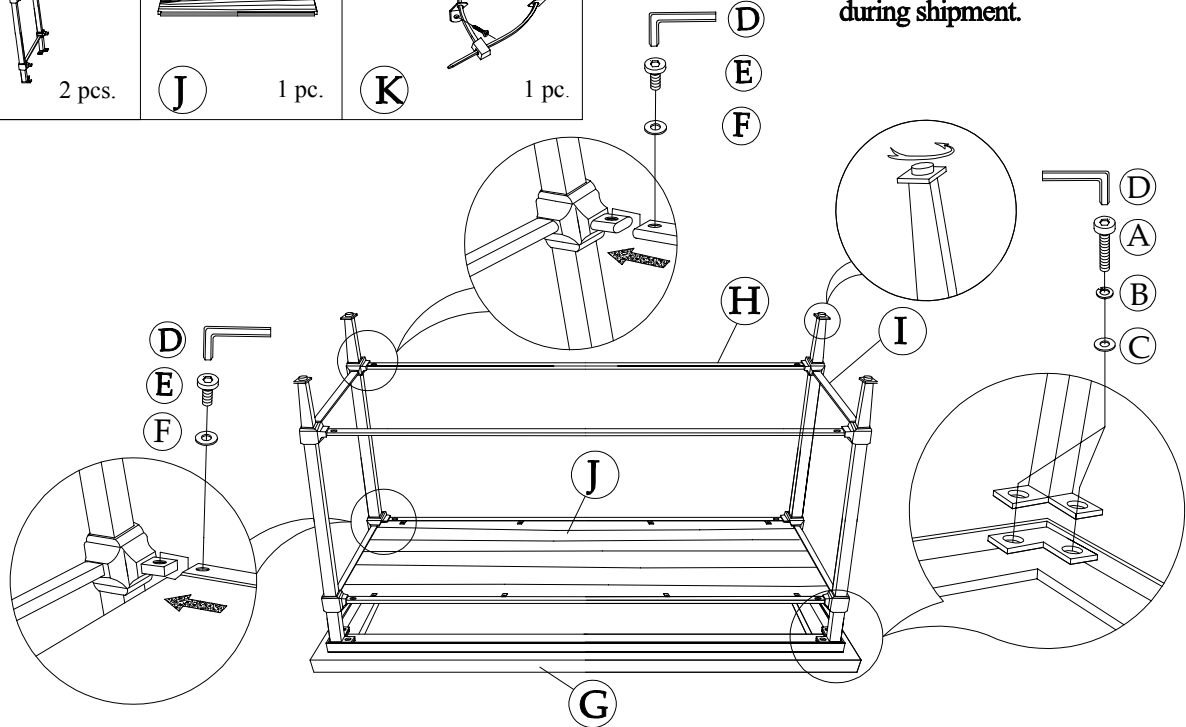

Note:

1. Do not discard any packing materials until the table has been completely assembled, to prevent parts from being accidentally discarded. To prevent possible scratches or damages, assemble the table on a soft surface such as a blanket or carpet, or it's own packaging materials.
2. Attach one Leg Assembly (I) to the Top (G) using the Large Flat Washers (C), Spring Washers (B) and long Allen Head Bolts (A). Do not fully tighten any bolts until after Step 5.
3. Attach the Middle Shelf (J) to the assembled Leg Assembly (I) using the Small Flat washers (F) and short Allen Head Bolts (E).
4. Attach the Stretcher Tubes (H) to the assembled Leg Assembly (I) using the Small Flat washers (F) and short Allen Head Bolts (E).
5. Attach remaining Leg Assembly to the Table Top, Middle Shelf & Stretcher Tubes as in previous steps.
6. Tighten all the bolts with the Allen Wrench (D).
7. Carefully turn the assembled table upright.
8. Levelers are installed into the bottom of the legs and can be used to compensate for uneven flooring if necessary.

If this table will be used with a TV, an Anti-Tipping Restraint has been included which can be used to minimize the risk of the furniture tipping forward, if used.

Notice: In homes where small children may be present, Riverside Furniture Corp. recommends that steps be taken for certain furniture items to prevent or minimize the risk of tip-over. This furniture is equipped with Tip-over Restraint Hardware for use to minimize this risk, if used. Please follow below installation steps. Riverside Furniture Corp. recommends that parents and guardians periodically visit the U.S. Consumer Product Safety Commission (CPSC) website at <http://www.cpsc.gov/> and stay up to date on all issues related to children's product safety.

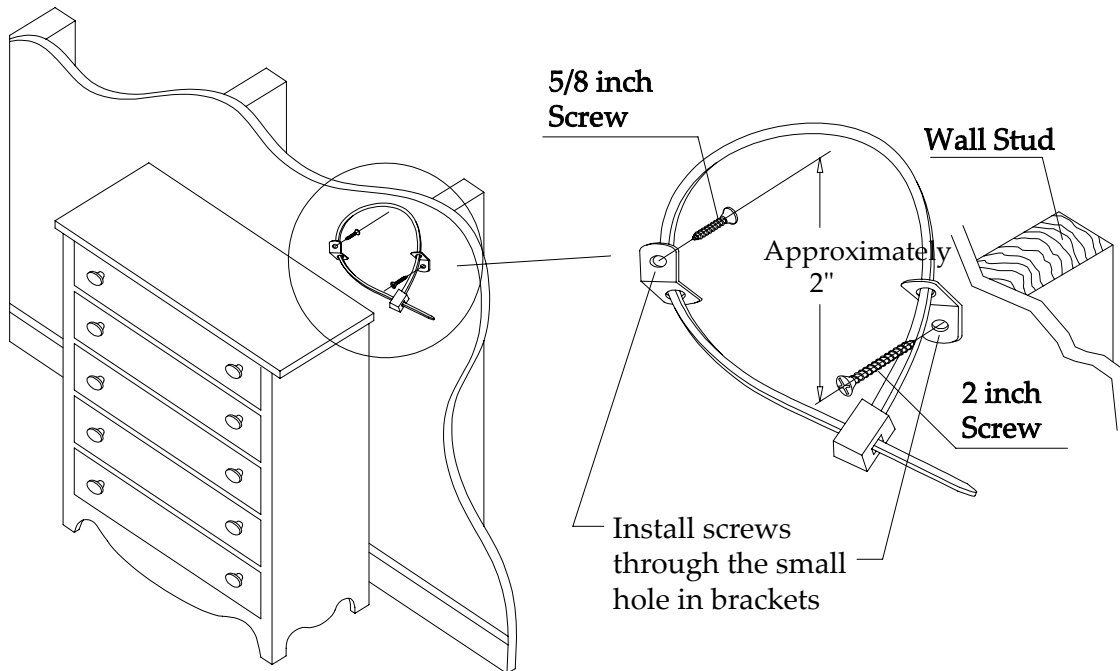

1. Temporarily locate the furniture to near its final location in the room next to a wall. Locate a wall stud behind your furniture and also mark the stud's location on the back of your furniture.
2. Firmly attach one bracket to the stud approximately 2" below the top of the furniture with the **2 inch long** Wood Screws provided. It may be necessary to drill 3/32 dia. pilot holes for the screws.
3. Firmly attach the other bracket onto a solid, structural part on the back of the furniture using the **5/8 inch long** Wood Screws. It may also be necessary to pilot bore for these screws.
4. Move the furniture into its final position, taking care to line up the wall bracket with the furniture bracket. Thread a strap through the bracket as shown in the illustration. Tighten strap until snug but do not over tighten.

Caution: Riverside Furniture Corp. assumes no liability for improper installation or excessive loads placed on screws, brackets or straps. Failure to detach this restraint before moving furniture may result in personal injury and property damage.

Warning: This tip-over restraint is not to be a substitute for proper adult supervision. Do not allow children to climb on furniture. Items left on top of the TV and furniture, such as toys, remote controls and treats might tempt young children to climb. Push the TV as far back as possible from the front of its stand. Place electrical cords out of a child's reach, and teach children not to play with the cords.