

# Riverside

FURNITURE

email [info@riverside-furniture.com](mailto:info@riverside-furniture.com).





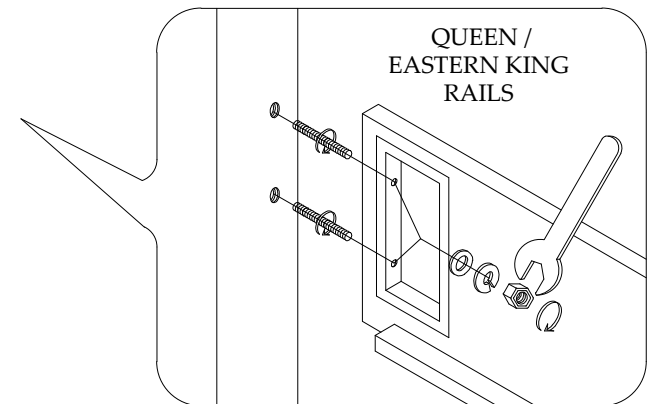
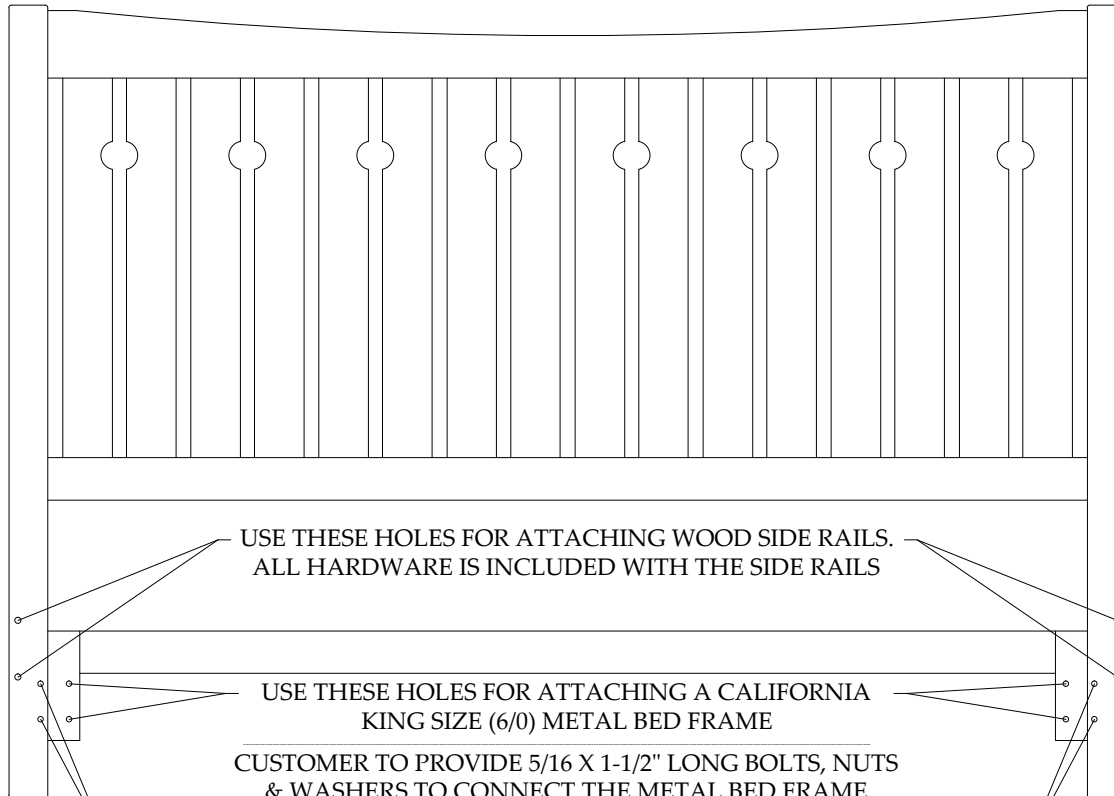

## #2980 King Size Headboard

For the Complete King Bed Use:  
#2980 King Headboard  
#2981 King Footboard & Slats  
#2972 Queen / King Rails

The Headboard may also be used  
alone with a Eastern King or  
California King Size  
Metal Bed Frame

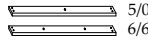

## Parts List

<p>M5/16" Spring Washer</p>  <p>(A) 8 pcs.</p>	<p>M5/16" Hex Nut</p>  <p>(B) 8 pcs.</p>	<p>M5/16" x 3-1/2" All-thread Bolt</p>  <p>(C) 8 pcs.</p>
<p>M5/16" Open Wrench</p>  <p>(D) 1 pc.</p>	<p>#8 x 1-1/4" Wood Screw</p>  <p>(E) 16 pcs.</p>	<p>Slat Support Leg</p>  <p>(F) 4 pcs. for 5/0 8 pcs. for 6/6</p>
<p>Wood Slat</p>  <p>(G) 4 pcs.</p>		

5/0 Queen Panel Bed Components  
#2970--5/0 Queen Panel Headboard  
#2971--5/0 Queen Panel Footboard & Slats  
#2972--5/0-6/6 Panel Bed Rails

6/6 King Panel Bed Components  
#2980--6/6 King Panel Headboard  
#2981--6/6 King Panel Footboard & Slats  
#2972--5/0-6/6 Panel Bed Rails

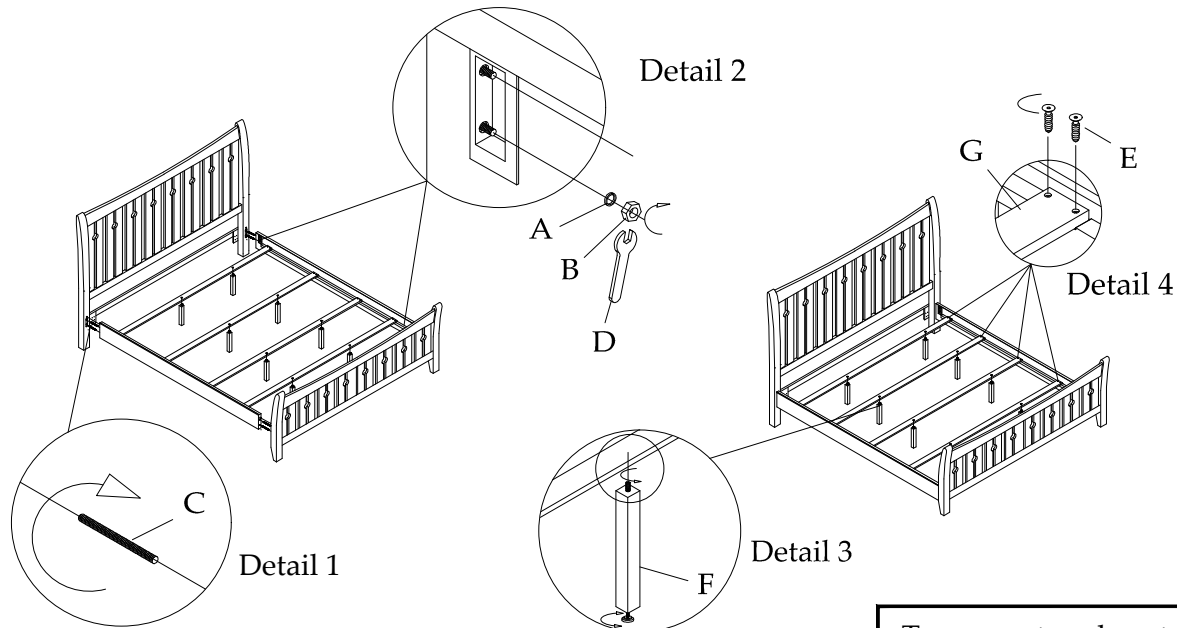
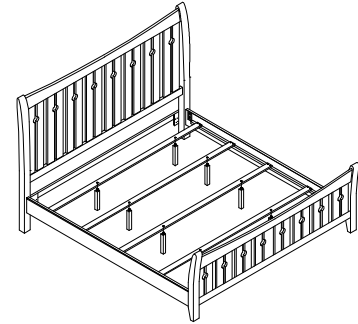
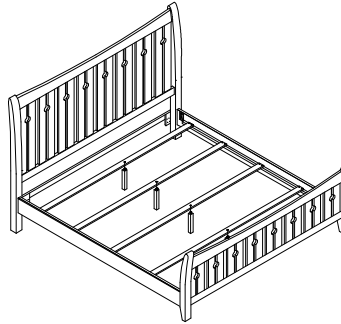

To prevent undue stress on any bed, always remove the mattress and box springs before moving bed.

### ASSEMBLY STEPS:

1. Install the eight All-Thread Bolts (C) into the threaded metal plates mounted on the Headboard and Footboard posts.
2. Gently lean the Headboard against the wall where the completed Bed will be located in the room.
3. Position one end of one Bed Rail onto the All-Thread Bolts and fasten with the Spring Washers (A) and Hex Nuts (B). Only partially tighten the Hex Nuts until the Footboard has been connected. Repeat for other Bed Rail.
4. Position and connect the Footboard to the other end of the Bed Rails as in previous Step.
5. Carefully align the Footboard to be 'square' with the Headboard. Using the Open Wrench (D) tighten all Hex Nuts attaching the Side Rails to the Headboard and Footboard.
6. Attach the Slat Support Leg (F) to the Wood Slat (G). Attach the Wood Slats to the Bed Rails using the Wood Screws (E) and your Phillips Screwdriver. The levelers located at the bottom of the Support Legs can be adjusted if necessary.