

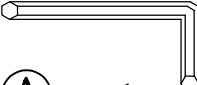

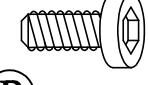



3410 Rect. End Table

Components and Hardware List

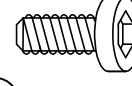
| | | | |
|---|---|---|---|
| <p>5mm Allen Wrench</p>  <p>(A) 1 pc.</p> | <p>M5/16" x 5/8" Allen Head Bolt</p>  <p>(B) 8 pcs.</p> | <p>5/16" Spring Washer</p>  <p>(C) 12 pcs.</p> | <p>5/16" x 22 x 2.0mm Flat Washer</p>  <p>(D) 12 pcs.</p> |
| <p>M5/16" x 1-1/2" Allen Head Bolt</p>  <p>(E) 4 pcs.</p> | <p>Top</p>  <p>(F) 1 pc.</p> | <p>Leg</p>  <p>(G) 4 pcs.</p> | <p>Bottom shelf</p>  <p>(H) 1 pc.</p> |

Be sure to check all packing material carefully for small parts, which may have come loose inside the carton during shipment.

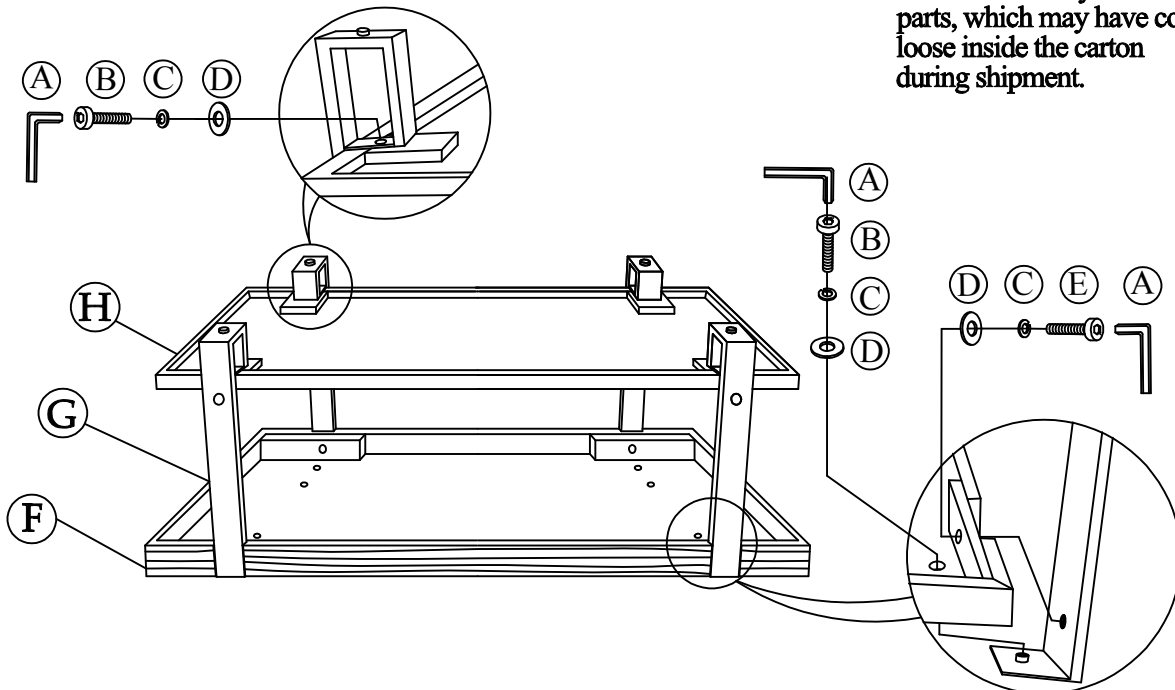

Note:

1. Do not discard any packing materials until the table has been completely assembled, to prevent parts from being accidentally discarded. To prevent possible scratches or damages, assemble the table upside down on a soft surface such as a blanket or carpet, or its own packaging materials.
2. Place three Legs (G) into the notches on the Top (F), then attach Legs to the Top using Flat washer (D), Spring washer (C) and Allen Head Bolts (B) & (E). Do not fully tighten bolts until after Step 4.
3. Attach the Bottom Shelf (H) to the Legs (G) using Flat washer (D), Spring washer (C) and Allen Head Bolts (B). Do not fully tighten bolts until after next step.
4. Attach the fourth leg (G) to the Top (F) & Bottom Shelf (H), using the same Washers and Bolts as in the previous steps.
5. Tighten all the Bolts using the Allen Wrench (A).
6. Carefully turn the table upright.
7. Levelers are installed into the bottom of the legs and can be used to compensate for uneven flooring if necessary.