







ASSEMBLY INSTRUCTIONS

45002 RECT COCKTAIL TABLE

45009 END TABLE

45015 SOFA TABLE

COMPONENT AND PARTS LIST

#	DESCRIPTION	QTY.	#	HARDWARE	SKETCH	QTY	EXTRA
1	TOP	1 PC	A	M5/16" X 3/4" ALLEN HEAD BOLT		8 PCS	1 PC
2	METAL LEG	4 PCS	B	M5/16" SPRING WASHER		8 PCS	1 PC
3	CENTER STRETCHER	1 PC	C	M5/16" FLAT WASHER		8 PCS	1 PC
			D	5mm ALLEN WRENCH		1 PC	
			E	M1/4" X 5/8" FLAT HEAD BOLT		4 PCS	1 PC
			F	4mm ALLEN WRENCH		1 PC	

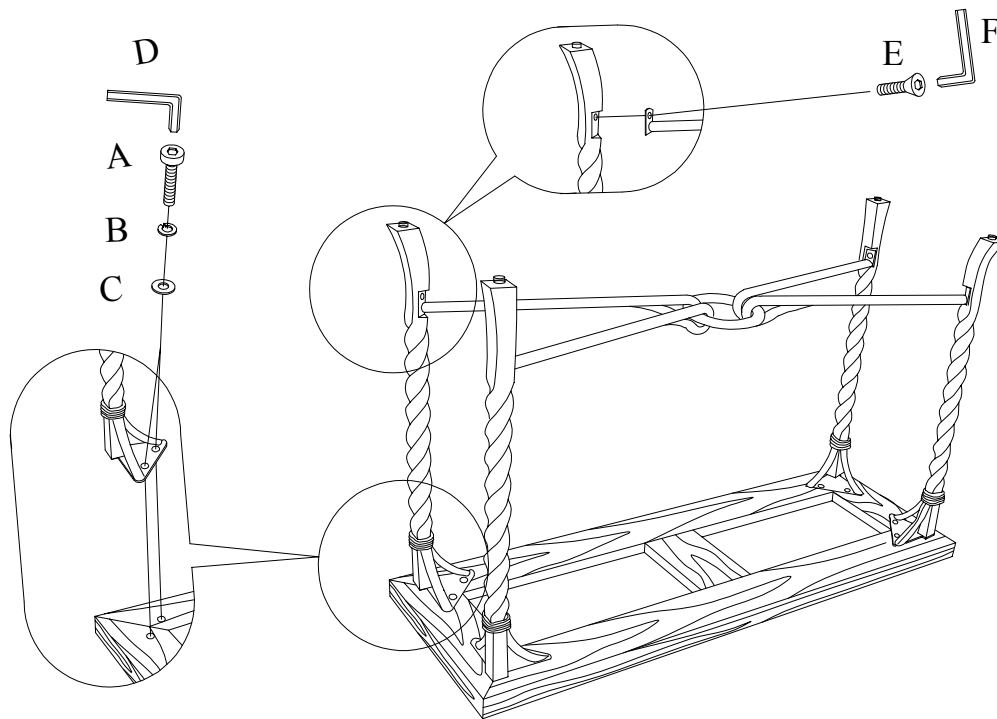

Note:

1. Do not discard any packing materials until the table has been completely assembled, to prevent parts from being accidentally discarded.
2. To prevent possible scratches or damage, assemble the table upside down on a soft surface such as a blanket or carpet.
3. Attach four legs to the Top using Allen head bolts (A), Spring Washers (B), and Flat Washers (C). Do not fully tighten until after next step.
4. Attach the Center Stretcher to the legs using the Flat head bolts (E).
5. Tighten all bolts using the appropriate Allen Wrenches (D or F) provided.
6. Carefully turn the Table upright.