

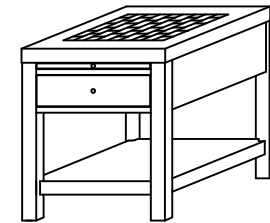







Components and Hardware List

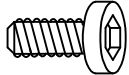

<p>5mm Allen Wrench</p>  <p>(A) 1 pc.</p>	<p>M5/16" x 2" Allen Head Bolt</p>  <p>(B) 12 pcs.</p>	<p>5/16" Spring Washer</p>  <p>(C) 12 pcs.</p>	<p>5/16" x 3/4" Flat Washer</p>  <p>(D) 12 pcs.</p>
<p>Top with Apron</p>  <p>(E) 1 pc.</p>	<p>Leg</p>  <p>(F) 4 pcs.</p>	<p>Bottom Shelf</p>  <p>(G) 1 pc.</p>	

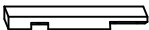

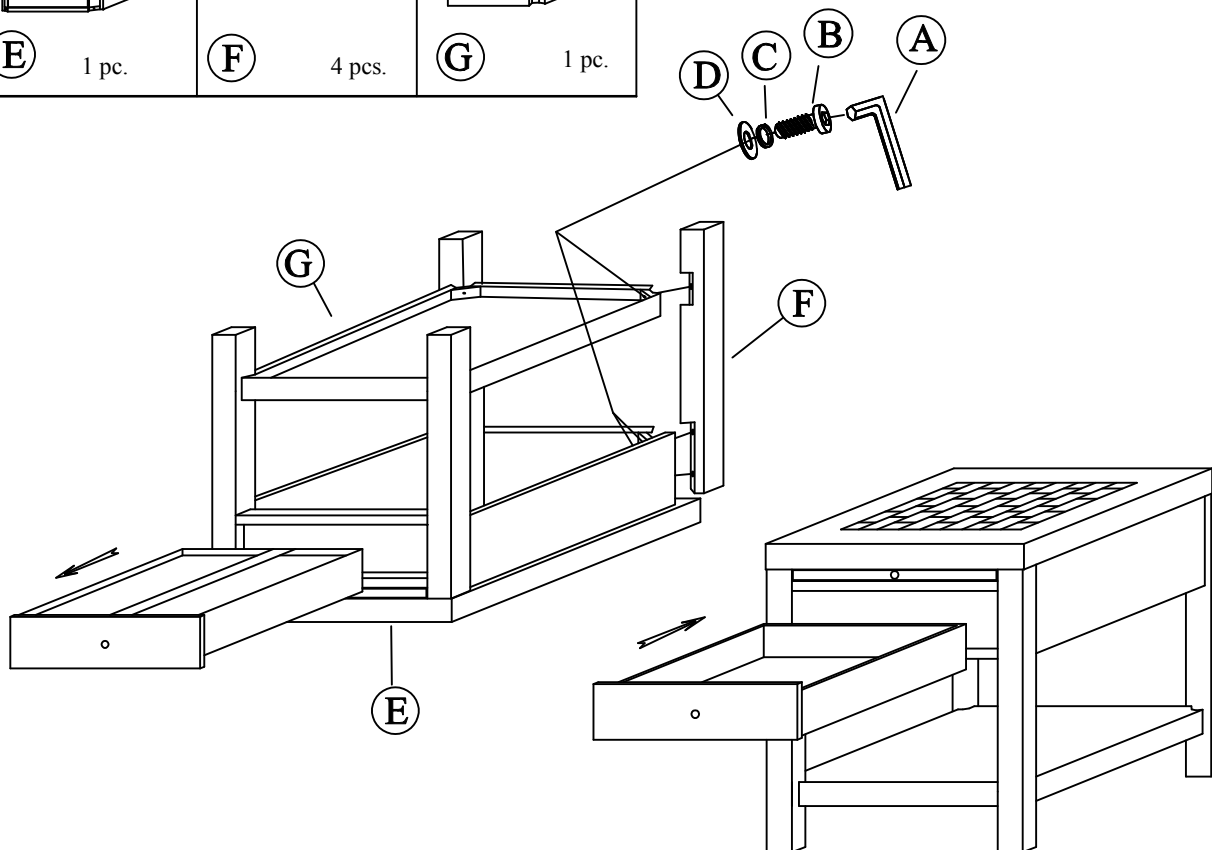
1. Do not discard any packing materials until the table has been completely assembled, to prevent parts from being accidentally discarded. To prevent possible scratches or damages, assemble the table upside down on a soft surface such as a blanket or carpet, or its own packaging materials. Remove the drawer and lay it aside.
2. Attach three Legs to the Table Top (E) using the 2" long Allen Head Bolts (B), Spring Washers (C), and Flat Washers (D). Do not fully tighten any bolts until after Step 4.
3. Assemble the Bottom Shelf (G) to the three legs previously assembled using the same bolts and washers as before.
4. Attach the last Leg to the Table Top and Shelf.
5. Tighten all Bolts using the Allen Wrench (A).
6. Carefully turn the Table upright and reinstall the drawer.