

## ASSEMBLY INSTRUCTIONS

INSTRUCCIONES DE MONTAJE

INSTRUCCIONES DE ENSAMBLAJE

### 6173

## “EasyMount” Partition Hanger

*Suspente pour la cloison de bureau*  
Percha para los particiones de oficinas

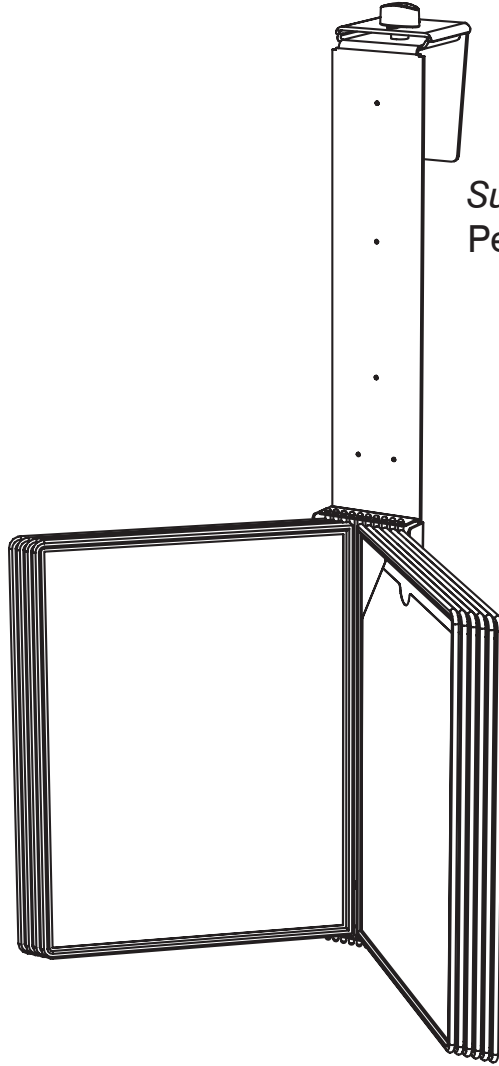

**PRODUCT WARRANTY REGISTRATION** is available online at: [www.safcoproducts.com](http://www.safcoproducts.com)

• L'INSCRIPTION POUR LA GARANTIE DU PRODUIT est disponible sur l'Internet : [www.safcoproducts.com](http://www.safcoproducts.com)

• EI REGISTRO PARA LA GARANTÍA DEL PRODUCTO está disponible en la Internet: [www.safcoproducts.com](http://www.safcoproducts.com)

For questions or concerns, please call **1-800-664-0042**  
available Monday-Friday 7:00 AM to 6:00 PM (Central Time) (English-speaking operators)

Si vous avez des questions pour poser ou les préoccupations pour exprimer, connecter **au 1-800-664-0042**  
de 7H00 à 18H00 (Heure centrale) (Opérateurs de langue anglaise)



Si usted tiene preguntas o preocupaciones, por favor llame **1-800-664-0042**  
de 7:00 AM a 6:00 PM (Hora Central) (Operadores que hablan inglés)

## TOOLS REQUIRED: Phillips Screwdriver

### PARTS LIST

| CODE | DESCRIPTION        | QTY | PART NO.  |
|------|--------------------|-----|-----------|
| (A)  | 10-Pocket Bracket  | 1   | 6173-01BL |
| (B)  | Panel Hanger       | 1   | 6173-02BL |
| (C)  | Adjustable Bracket | 1   | 6173-03BL |
| (D)  | Literature Pocket  | 10  | 6160-06BL |

### HARDWARE PACK 6173-19NC

|   |   |   |
|---|---|---|
| (E)  | (F)  | (G)  |
| Knob<br>Qty.: 1<br>#6173-23BL   | Washer<br>Qty.: 1<br>#6173-31NC   | Screw<br>Qty.: 3<br>#6173-27NC  |

### HARDWARE PACK 6173-99NC

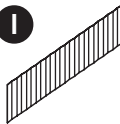

|   |   |
|---|---|
| (H)  | (I)  |
| Index Tab<br>(not shown)<br>Qty.: 10<br>#6173-11CL                                      | Label Sheet<br>(not shown)<br>Qty.: 1<br>#6173-35NC                                     |

## OUTILS REQUIS : Tournevis à pointe cruciforme

### LISTE DES PIÈCES

| CODE | DESCRIPTION               | QUANTITÉ | N° DE PIÈCE |
|------|---------------------------|----------|-------------|
| (A)  | Support pour 10 poches    | 1        | 6173-01BL   |
| (B)  | Support pour la partition | 1        | 6173-02BL   |
| (C)  | Support ajustable         | 1        | 6173-03BL   |
| (D)  | Poche pour la littérature | 10       | 6160-06BL   |

### PAQUET MATÉRIEL 6173-19NC

|   |   |   |
|---|---|---|
| (E)  | (F)  | (G)  |
| Bouton<br>Qte.: 1<br>#6173-23BL   | Rondelle<br>Qte.: 1<br>#6173-31NC   | Vis<br>Qte.: 3<br>#6173-27NC  |

### PAQUET MATÉRIEL 6173-99NC

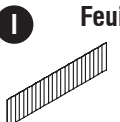

|   |   |
|---|---|
| (H)  | (I)  |
| Onglet Index<br>(non montré)<br>Qte.: 10<br>#6173-11CL                                    | Feuille d'étiquettes<br>(non montré)<br>Qte.: 1<br>#6173-35NC                             |

## HERRAMIENTAS REQUERIDAS: Destornillador Phillips

### LISTA DE PIEZAS

| CODIGO | DESCRIPCIÓN                 | CANTIDAD | NO. DE PIEZA |
|--------|-----------------------------|----------|--------------|
| (A)    | Soporte de 10 bolsillos     | 1        | 6173-01BL    |
| (B)    | Soporte para la partición   | 1        | 6173-02BL    |
| (C)    | Soporte ajustable           | 1        | 6173-03BL    |
| (D)    | Bolsillo para la literatura | 10       | 6160-06BL    |

### PAQUETE MATERIAL 6173-19NC

|   |   |   |
|---|---|---|
| (E)  | (F)  | (G)  |
| Perilla<br>Cant.: 1<br>#6173-23BL   | Arandela<br>Cant.: 1<br>#6173-31NC  | Tornillo<br>Cant.: 3<br>#6173-27NC  |

### PAQUETE MATERIAL 6173-99NC

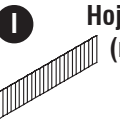
|   |   |
|---|---|
| (H)  | (I)  |
| Pestaña Índice<br>(no se muestra)<br>Cant.: 10<br>#6173-11CL                              | Hoja de etiquetas<br>(no se muestra)<br>Cant.: 1<br>#6173-35NC                            |

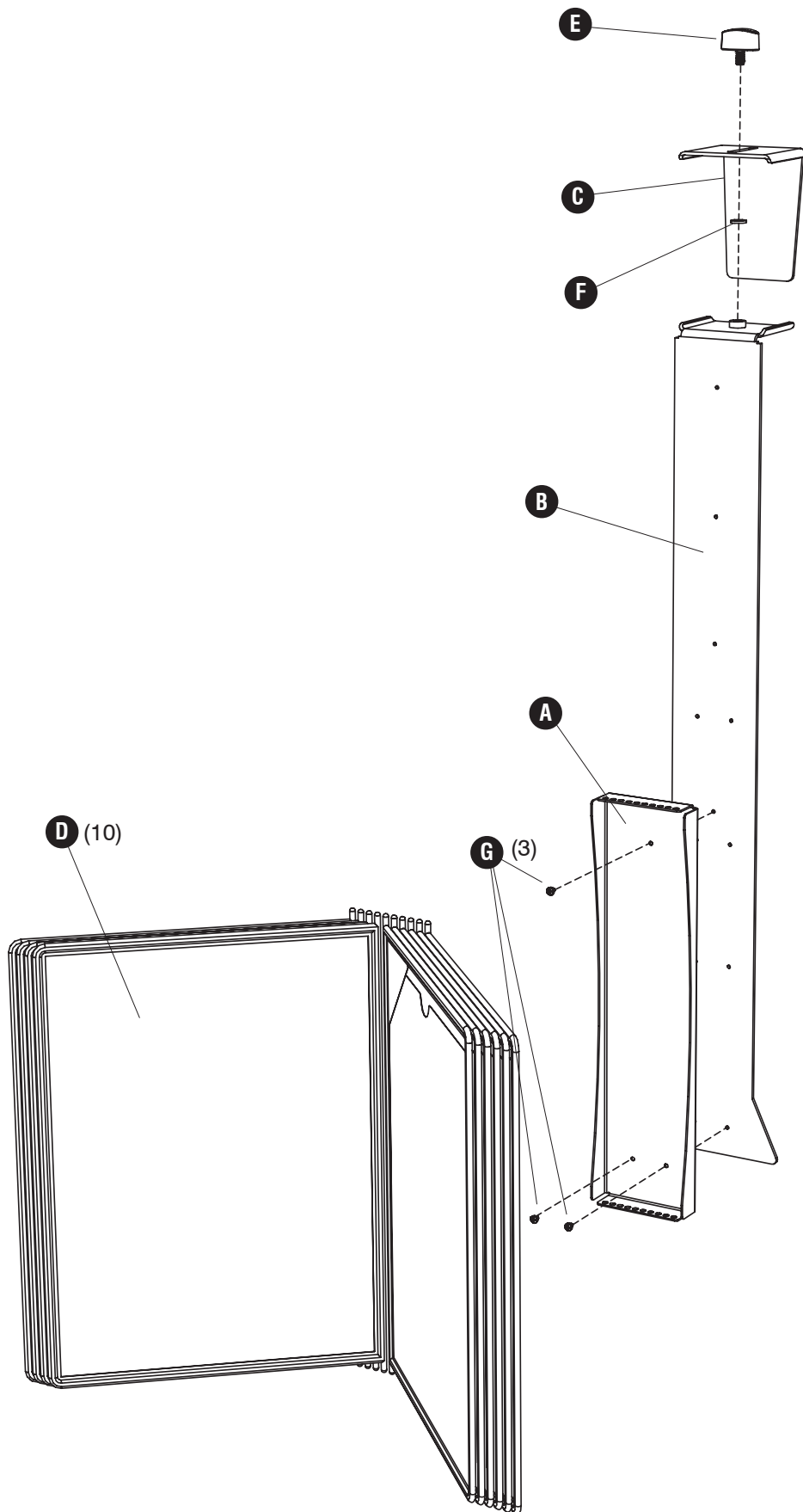

- 1** **E** (1) **F** (1)

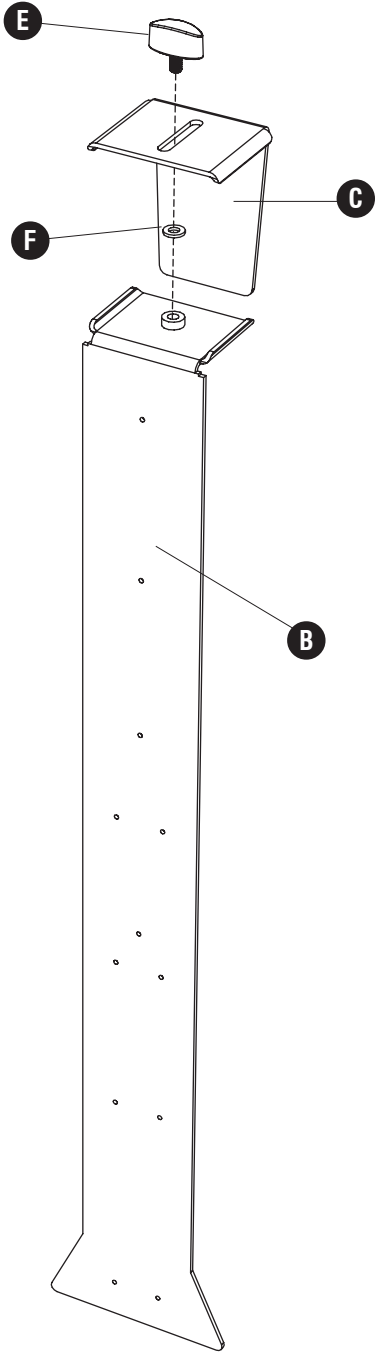

**2**

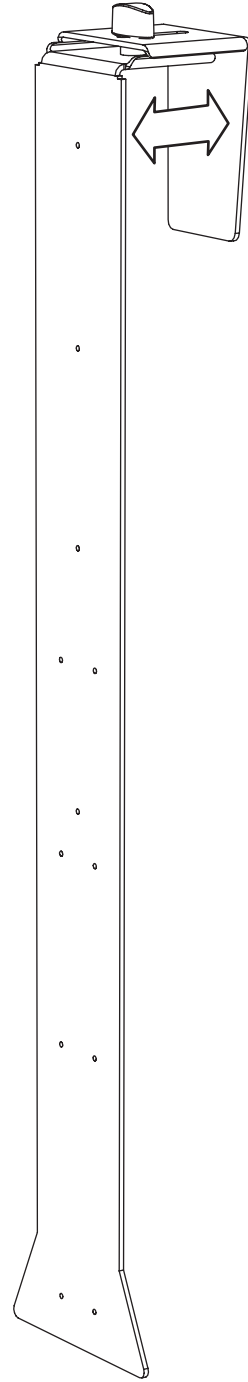

**3** **G**  (3)

**Alternate positions**  
*Autres emplacements*  
Posiciones alternos

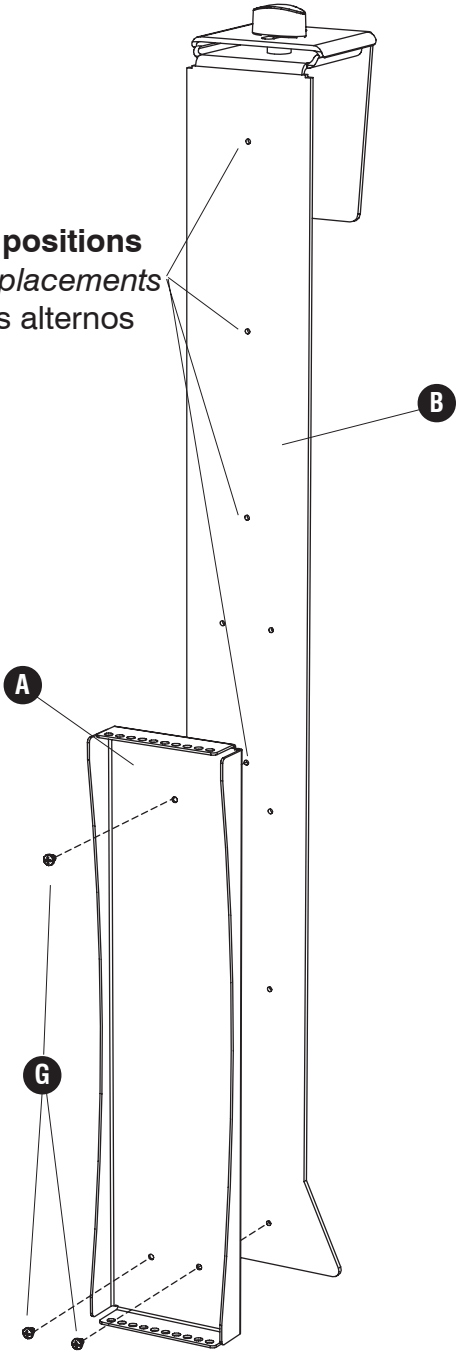

**4**

