



an LDI Company

New Hope, MN 55428  
www.safcoproducts.com

# ASSEMBLY INSTRUCTIONS

## INSTRUCTIONS DE MONTAGE

## INSTRUCCIONES DE ENSAMBLAJE

# 6265, 6266, 6267

## Commercial Shelving

*Étagères industrielle*  
Esterantería industrial

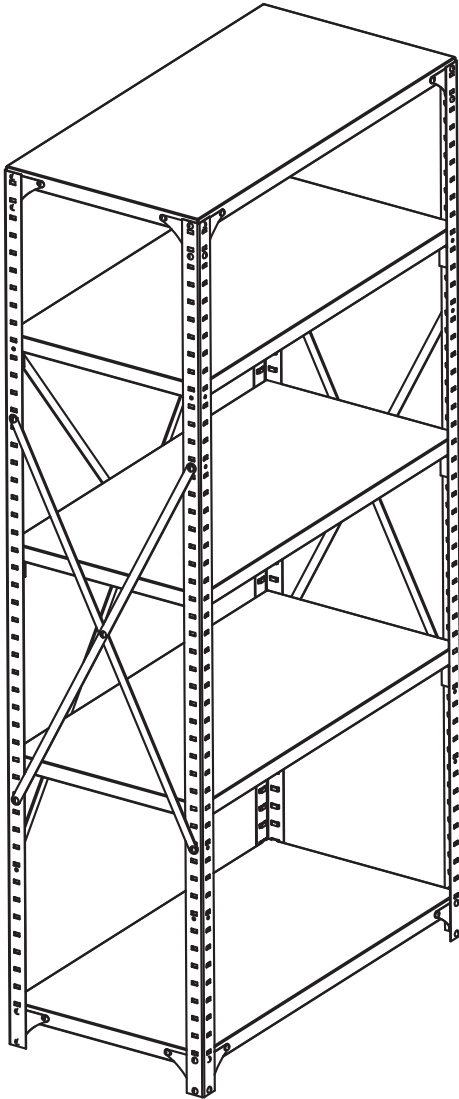

**Two people  
recommended**  
*Deux personnes ont  
recommandé*  
Dos personas  
recomendadas

**PRODUCT WARRANTY REGISTRATION** is available online at: [www.safcoproducts.com](http://www.safcoproducts.com)

• L'INSCRIPTION POUR LA GARANTIE DU PRODUIT est disponible sur l'Internet : [www.safcoproducts.com](http://www.safcoproducts.com)

• EI REGISTRO PARA LA GARANTÍA DEL PRODUCTO está disponible en la Internet: [www.safcoproducts.com](http://www.safcoproducts.com)

For questions or concerns, please call **1-800-664-0042**  
available Monday-Friday 7:00 AM to 6:00 PM (Central Time) (English-speaking operators)

Si vous avez des questions pour poser ou les préoccupations pour exprimer, connecter **au 1-800-664-0042**  
de 7H00 à 18H00 (Heure centrale) (Opérateurs de langue anglaise)





Si usted tiene preguntas o preocupaciones, por favor llame **1-800-664-0042**  
de 7:00 AM a 6:00 PM (Hora Central) (Operadores que hablan inglés)

## TOOLS REQUIRED: Screwdriver; Rubber Mallet

### PARTS LIST

CODE	DESCRIPTION	QTY	PART NO.
(A)	Post 75" high	4	6265-03GR
(B)	Steel Shelf Top and Bottom 12" x 36" 18" x 36" 24" x 36"	2	6265-01GR\$ 6266-01GR\$ 6267-01GR\$
(C)	Steel Shelf center 12" x 36" 18" x 36" 24" x 36"	3	6265-02GR\$ 6266-02GR\$ 6267-02GR\$
(D)	Long Brace	2	6256-03GR
(E)	Short Brace	4	6256-02GR

### HARDWARE PACK 6265-19NC

<b>F</b> 	<b>G</b> 	<b>H</b> 	<b>I</b> 	<b>J</b> 
Corner Clip Qty: 12 6250-26NC	Screw Qty: 63 6256-24NC	Nut Qty: 63 6256-25NC	Plastic Foot Qty: 4 6256-05NC	Corner Plate Qty: 16 6256-04GR

§ Note: When corresponding about the product don't forget to mention the shelf size.





To ensure that you have enough screws and nuts, extras have been included.

## OUTILS REQUIS : Tournevis; Maillet du caoutchouc

### LISTE DES PIÈCES

CODE	DESCRIPTION	QTY	PART NO.
(A)	Poste 75" de haut	4	6265-03GR
(B)	Étagère en acier haut et en bas 12" x 36" 18" x 36" 24" x 36"	2	6265-01GR\$ 6266-01GR\$ 6267-01GR\$
(C)	Étagère en acier Centre 12" x 36" 18" x 36" 24" x 36"	3	6265-02GR\$ 6266-02GR\$ 6267-02GR\$
(D)	longue étrésillon	2	6256-03GR
(E)	Court étrésillon	4	6256-02GR

### PAQUET MATÉRIAL 6265-19NC

<b>F</b> 	<b>G</b> 	<b>H</b> 	<b>I</b> 	<b>J</b> 
Coin équerre Qté: 12 6250-26NC	Vis Qté: 63 6256-24NC	Écrou Qté: 63 6256-25NC	Plastique pied Qté: 4 6256-05NC	Coin plaque Qté: 16 6256-04GR

§ Noter: Lorsque vous correspondez au sujet du produit, n'oubliez pas de mentionner la taille du Étagère.





Pour veiller à ce que vous avez suffisamment de vis et les écrous, les suppléments ont été inclus.

## HERRAMIENTAS REQUERIDAS: Destornillador ;Mazo de caucho

### LISTA DE PIEZAS

CODE	DESCRIPTION	QTY	PART NO.
(A)	Post 75" de alto	4	6265-03GR
(B)	Estante de acero parte superior e inferior 12" x 36" 18" x 36" 24" x 36"	2	6265-01GR\$ 6266-01GR\$ 6267-01GR\$
(C)	Estante de acero Centro 12" x 36" 18" x 36" 24" x 36"	3	6265-02GR\$ 6266-02GR\$ 6267-02GR\$
(D)	Puntal largo	2	6256-03GR
(E)	Corto puntal	4	6256-02GR

### PAQUETE MATERIAL 6265-19NC

<b>F</b> 	<b>G</b> 	<b>H</b> 	<b>I</b> 	<b>J</b> 
Soporte de esquina Cant: 12 6250-26NC	Tornillo Cant: 63 6250-26NC	Tuerca Cant: 63 6256-25NC	Pie de plástico Cant: 4 6256-05NC	Esquina placa Cant: 16 6256-04GR

§ Nota: Cuando correspondientes sobre el producto no se olvide de mencionar el tamaño de la Estante.

Para asegurarse de que tiene suficiente tornillos y tuercas, los extras se han incluido.

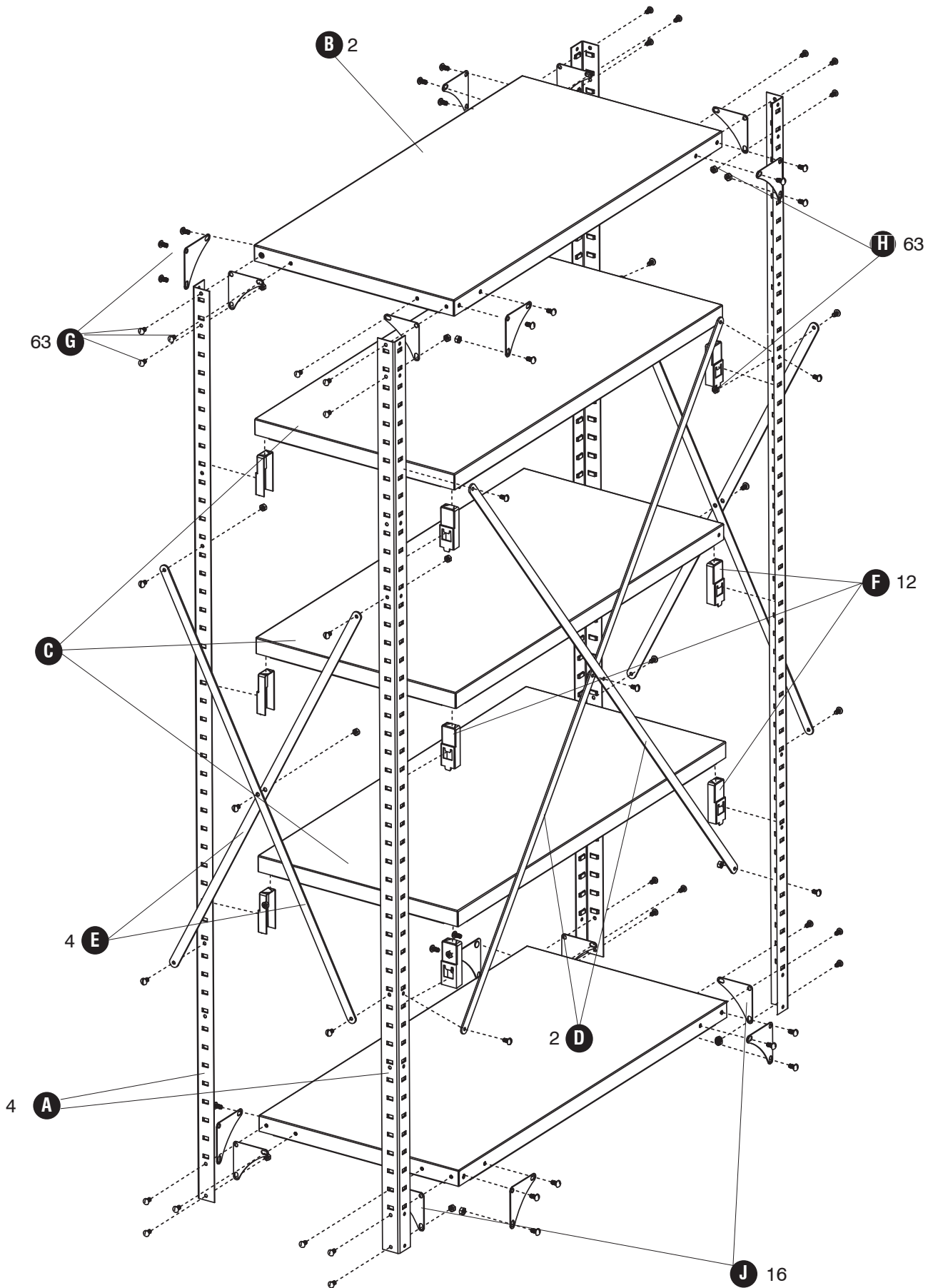

- 1 **G** 24 **H** 24 **I** 4 **J** 8

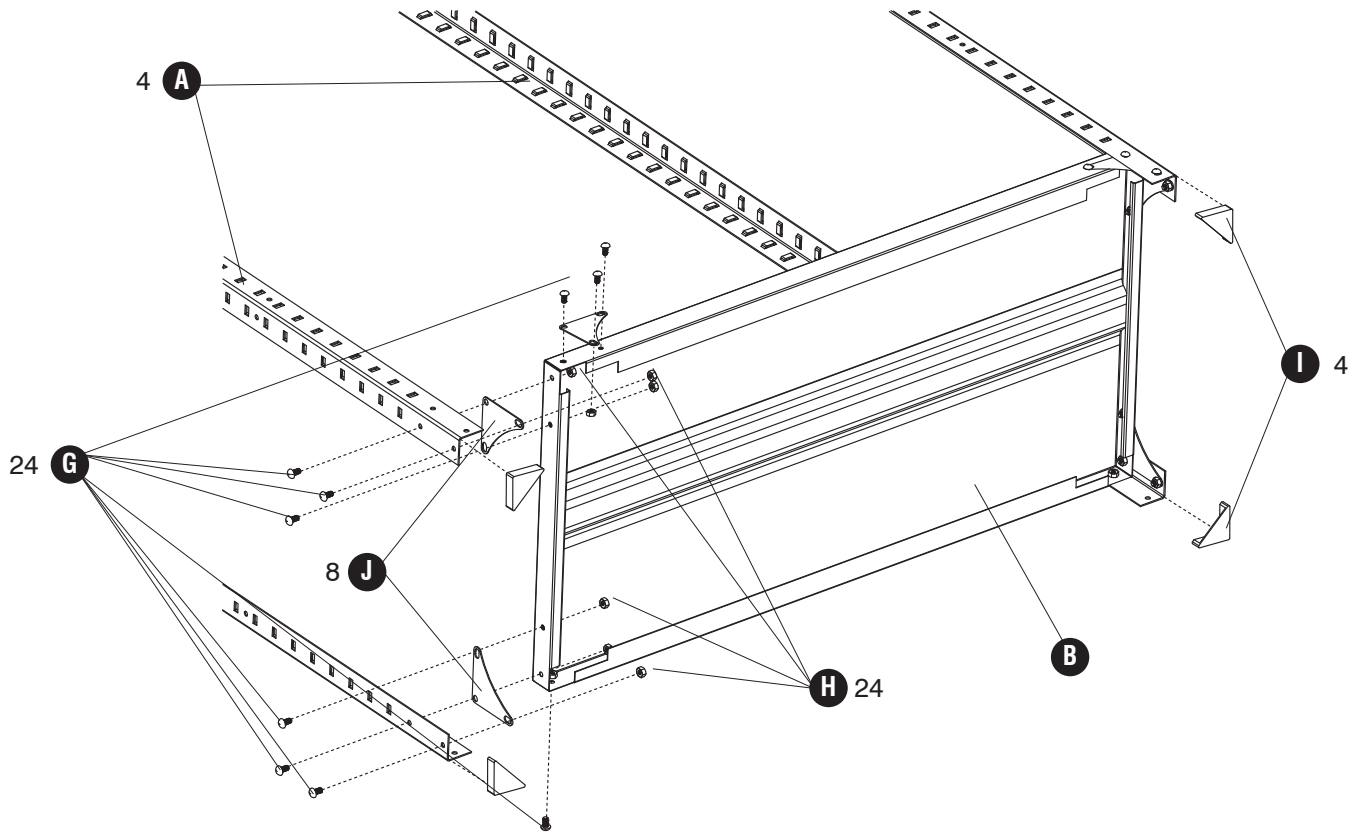

- 2 **G** 24 **H** 24 **J** 8

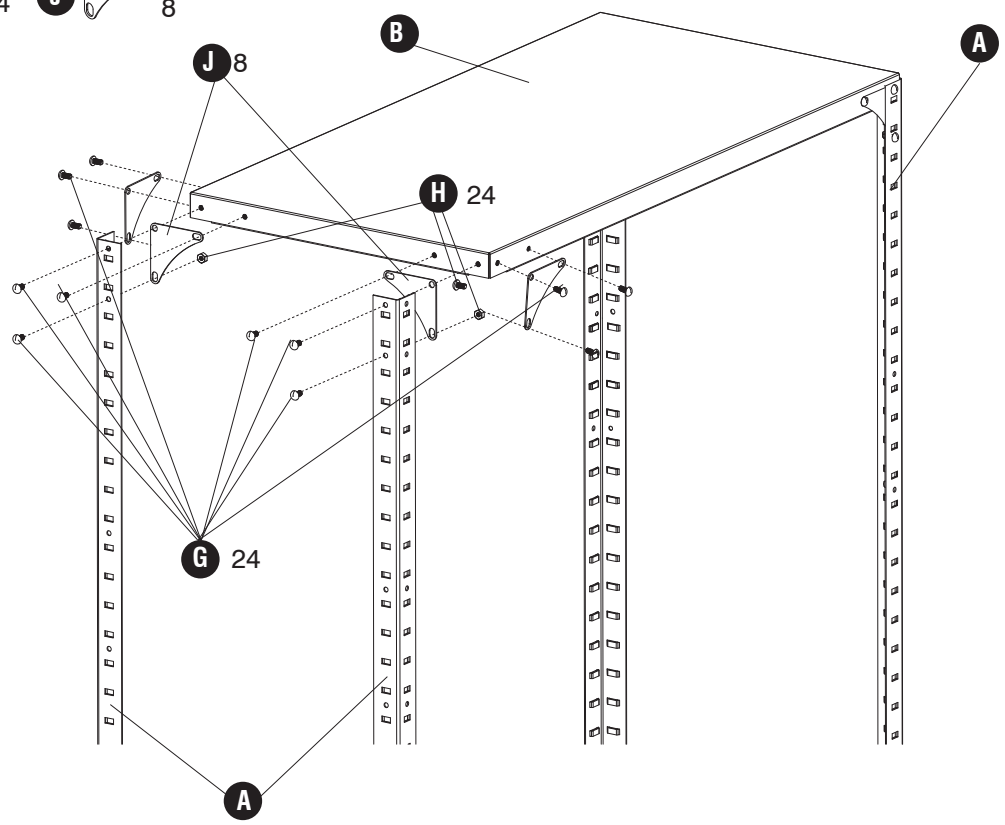

3 G 15 H 15

**NOTE: Refer to the chart below for placement of braces on the different size shelving units.**

*NOTER: Consultez le tableau ci-dessous pour le placement des renforts sur la différents taille des étagères.*

*NOTA: Consulte la tabla de abajo para la colocación de soporte para el tamaño de diferentes estanterías*

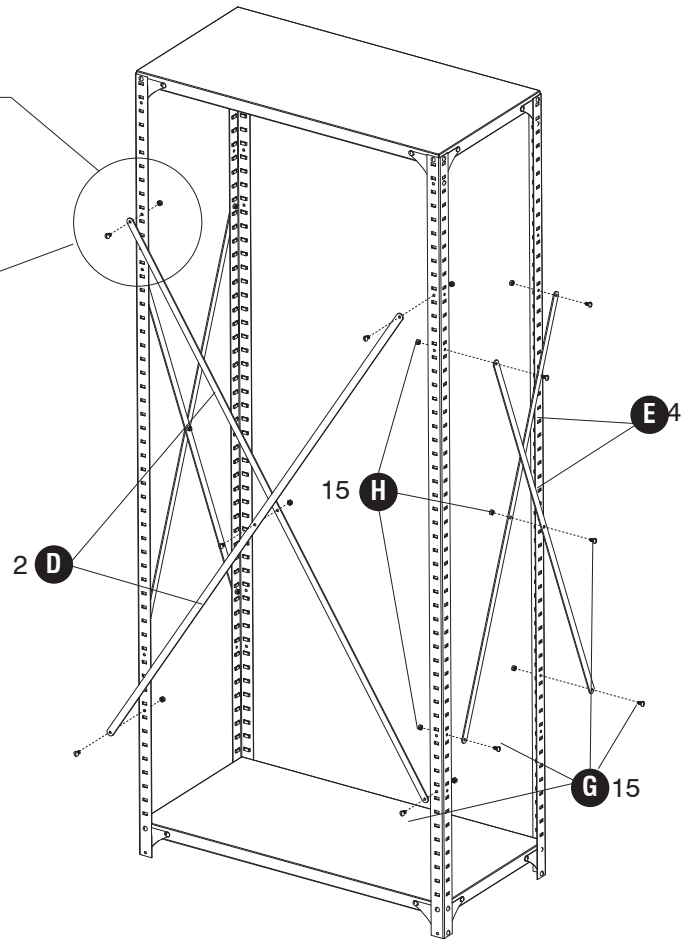
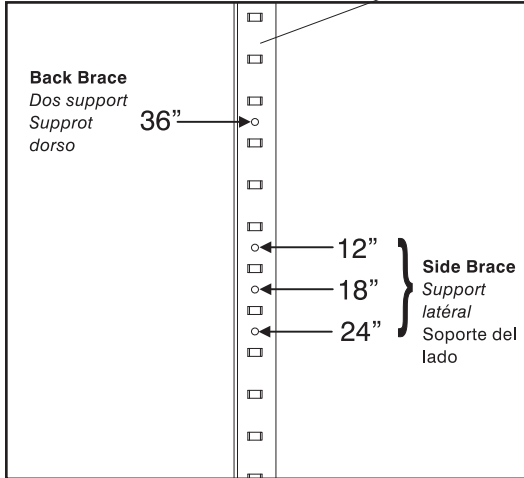

4

