



Rotaliana

Icselle

Design: Donegani & Lauda

Istruzioni
di montaggio
e d'uso

Assembly
and operating
instructions

Instructions
de montage
et utilisation

Gebrauchs- und
Montageanleitungen

Instrucciones
de montaje
y utilización

Monterings-
och Bruksanvisningar

made in Italy



12/2009 web

- I**
- Seguire attentamente le istruzioni di montaggio e d'uso per garantire un funzionamento corretto e sicuro dell'apparecchio.
 - Conservare le istruzioni per future necessità. Per eventuali problemi contattare il rivenditore.
 - Il prodotto non deve essere modificato. Qualsiasi modifica annulla le approvazioni di sicurezza e può rendere pericoloso l'apparecchio.
 - Rotaliana declina ogni responsabilità per danni causati a cose o a persone da un non corretto uso dell'apparecchio.

- GB**
- Follow carefully the assembly and use instructions to guarantee a correct and safe function of the product.
 - Keep the instructions for future needs. For any problems, get in touch with your supplier.
 - The product must not be modified. Any change will nullify the safety guarantees and may make the product dangerous.
 - Rotaliana declines all responsibility for damage caused to things or persons by any improper use of the product.

- F**
- Suivre soigneusement les instructions de montage et utilisation pour garantir un correct et sûr fonctionnement de l'appareil.
 - Garder les instructions pour des futures nécessités. Pour tous problèmes, contacter le revendeur.
 - Le produit ne doit pas être modifié. Toute modification annule les approbations de sécurité et peut rendre dangereux l'appareil.
 - Rotaliana décline toute responsabilité pour les dégâts causés à choses ou personnes dus à une incorrecte utilisation de l'appareil.

- D**
- Bitte lesen Sie die Montage- und Gebrauchsanleitungen aufmerksam, um eine richtige und gefahrlose Arbeitsweise der Produkt zu gewährleisten.
 - Bewahren Sie die Anweisungen für zukünftige Notfälle auf.
 - Das Produkt darf nicht verändert werden. Jede Änderung annulliert die Sicherheitsbestimmungen und könnte zu einer Gefährdung durch die Produkt führen.
 - Rotaliana ist nicht für Schäden verantwortlich, die durch Dritte bei unsachgemäßen Anwendung der Produkt verursacht werden.

- E**
- Seguir atentamente las instrucciones de montaje y uso para garantizar un funcionamiento correcto y seguro del aparato.
 - Conservar las instrucciones para consultas futuras en caso de necesidad. Ante la presencia de eventuales problemas contactar al revendedor.
 - El producto no deberá ser modificado. Cualquier modificación anulará las probaciones de seguridad y podrá hacer que el aparato resulte peligroso.
 - Rotaliana declina toda responsabilidad por daños causados a cosas o a personas debido a un uso incorrecto del aparato.

- S**
- Läs bruksanvisningen noggrant för att säkerställa ett korrekt och säkert användande av produkten;
 - Spara bruksanvisningen för framtida bruk. Får Du problem, kontakta Din återförsäljare;
 - Produkten få inte ändras. Ändringen kan medföra att produktsäkerheten åsidosätts och att produkten därmed inte längre uppfyller gällande säkerhetsstandard;
 - Rotaliana avsäger sig allt ansvar för skador som är orsakade av ett felaktigt användande av produkten.

Rotaliana srl
via della rupe 35
38017 mezzolombardo
(trento) italia
tel +39 0461 602376
fax +39 0461 602539
info@rotaliana.it
www.rotaliana.it



AVVERTENZE GENERALI DI SICUREZZA - MANUTENZIONE



Installazione, manutenzione dell'apparecchio e/o sostituzione della lampadina. Prima di qualsiasi operazione estrarre sempre la spina dalla presa di corrente o togliere l'alimentazione generale dell'impianto elettrico. Nel caso di installazione di sospensioni/applique rivolgersi sempre a personale qualificato.



Non toccare l'ampolla con le dita: le impronte digitali riducono la durata e la luminosità della lampadina alogena. In caso di contatto con le dita, pulire l'ampolla di vetro con un panno morbido.



Quando la lampadina è accesa l'ampolla di vetro può raggiungere temperature fino a 350°C. È quindi assolutamente necessario lasciare raffreddare la lampadina prima di sostituire le lampadine. Al momento della prima accensione può verificarsi una leggera e poco importante formazione di fumo. Residui come olio o altro (risultati dalla produzione e dal montaggio della lampada) evaporano a causa del notevole calore sviluppato dalla lampadina.



Le parti che conducono corrente non devono entrare in contatto con l'umidità. **Le superfici quali paralumi, vetri, riflettori e coperture possono essere pulite con un panno morbido senza detersivo.** Proteggere la lampada dall'umidità durante l'uso.



In caso di sostituzione della lampadina, fare attenzione che le sue caratteristiche elettriche (tensione in V, potenza in W) siano uguali ai dati di targa della lampada.

SIMBOLOGIA



Classe II. Apparecchio nel quale la protezione contro la scossa elettrica non si basa unicamente sull'isolamento principale ma anche sulle misure supplementari di sicurezza costituite dal doppio isolamento o dall'isolamento rinforzato.



Apparecchi predisposti per il montaggio diretto su superfici normalmente infiammabili. Temperatura massima sulla base di appoggio T_{max}=90°C.



Distanza minima in metri dagli oggetti illuminati. Nota: è necessario rispettare la distanza minima indicata sull'apparecchio, per evitare che gli oggetti illuminati, situati troppo vicini alla fonte, raggiungano temperature elevate.

IP 20

Indice di protezione IP 20. Protezione contro l'ingresso di corpi solidi di Ø 12 mm. Nessuna protezione contro la pioggia. Marcatura non prevista sull'apparecchio.



ATTENZIONE L'apparecchio non deve essere smaltito come rifiuto urbano. Deve essere soggetto a raccolta separata per evitare danni all'ambiente. Nel rispetto della Direttiva 2002/96 e delle Leggi nazionali di recepimento per lo smaltimento del prodotto a fine vita, il mancato rispetto di quanto sopra è sanzionato dalla Legge. Si prega di informarsi in merito al sistema locale di raccolta differenziata per i prodotti elettrici ed elettronici.

CARATTERISTICHE TECNICHE

Alimentazione dell'apparecchio: 230-240V 50Hz

Tipo/potenza	ICSELLE H1		
	E27 1x200W	E27 1x250W	E27 1x24W
Codice ZWEI	A80	QT32	TC-SER
Codice ILCOS	IAA/C	HSGST/C	FBC
Lampadina	 H=123mm		
Distanza minima	0,5 m	0,5 m	0,2 m



GENERAL SAFETY WARNING



Fitting and maintaining the unit and/or replacing the bulb. Before doing anything, always remove the lamp plug from its socket or turn off the lamp supply circuit, and leave the bulb to cool. When fitting hanging lamps or fixtures always use qualified personnel.



Do not touch the bulb with your bare fingers: fingerprints reduce the life and the luminosity of halogen bulbs. In the event of contact with fingers, clean the bulb with a soft cloth.



When the lamp is switched on, the bulb can reach a temperature of up to 350°C. It is therefore of fundamental importance to let it cool before replacing the bulb. A slight, insignificant amount of smoke may be given off when the lamp is first turned on. This occurs when residues of oils and other substances (from production and assembly operations) are vaporised by the great heat developed by the bulb.



Parts that conduct current must not be exposed to humidity. **Surfaces such as lampshades, glasses, reflectors and covers can be cleaned with a soft cloth but without using detergents.** Protect the lamp from humidity during use.



When replacing the lamp, make sure that the electrical characteristics (tension in V, power rating in W) match the values shown on the lamp plate.

KEY TO SYMBOLS



Class II. A luminaire in which protection against electric shock relies not just on basic insulation, but where additional safety precautions such as double insulation or reinforced insulation are provided.



Luminaire designed for direct mounting on normally inflammable surfaces. Maximum temperature at the base of the installation surface T_{max} = 90°C.



Minimum distance from any illuminated object (in meters). Note: the minimum distance shown on the device must be respected, to avoid the risk of illuminated objects sited too near the light source reaching high temperatures.

IP 20

Protection level IP 20. Protection is effective against contact with solid bodies of Ø ≥ 12 mm. No protection is provided against rain. No indications are provided on the luminaire.



ATTENTION The product cannot be disposed as unsorted municipal waste. It must be collected separately to prevent negative environmental impacts. In accordance with the procedures of Directive 2002/96 and relevant national laws and regulations adopted pursuant to this Directive on the disposal of waste at the end of the life cycle of the product, any violation is sanctioned by law. Please inform yourself about the local separate collection system for electrical and electronic products.

TECHNICAL CHARACTERISTICS

Supply voltage to the lamp: Europe 230-240V 50Hz

	ICSELLE H1			
	Europe			U.S.A.
Type/power	E27 1x200W	E27 1x250W	E27 1x24W	E26 1xmax250W
ZWEI Code	A80	QT32	TC-SER	
ILCOS Code	IAA/C	HSGST/C	FBC	
U.S.A. Code				Halogen T10
Lamp	 H=123mm			
Minimum distance	0,5 m	0,5 m	0,2 m	



AVERTISSEMENT GÉNÉRAL DE SÉCURITÉ



Installation, entretien de l'appareil et/ou remplacement de l'ampoule. Avant toute opération, débrancher la prise de courant ou couper l'alimentation générale de la distribution d'électricité. L'installation des suspensions/appliques doit être effectuée par personnel spécialisé.



Ne pas toucher l'ampoule directement avec les doigts: les empreintes digitales réduisent la durée et la luminosité de l'ampoule halogène. En cas de contact avec les doigts, nettoyer l'ampoule avec un tissu souple.



Quand l'appareil est en marche, la température de l'ampoule peut monter jusqu'à 350° C. C'est la raison pour laquelle il faut absolument la laisser refroidir avant de la remplacer. Au premier allumage il y a la possibilité qu'il se produise une légère et peu importante quantité de fumée. Des restants d'huile et autre (résultats de la production et du montage de l'appareil) évaporent à cause de la considérable chaleur développée par l'ampoule.



Les parties qui conduisent le courant électrique ne doivent jamais entrer en contact avec l'humidité. **Les surfaces comme abat-jours, verres, réflecteurs et couvertures peuvent être nettoyées avec un tissu souple sans détergent.** Protéger l'appareil contre l'humidité pendant son utilisation.



En cas de remplacement de l'ampoule, faire attention que ses caractéristiques électriques (tension en V, puissance en W) soient conformes aux données techniques de l'appareil.

SYMOLES



Classe II. Appareil dans lequel la protection contre la décharge électrique ne se base pas uniquement sur l'isolation principale mais aussi sur les mesures supplémentaires de sécurité constituées par une double isolation renforcée.



Appareils prédisposés pour le montage direct sur des surfaces normalement inflammables. Température maximum sur la base d'appui T_{max}=90°C.



Distance minimum à garder des objets illuminés en mètres. Annotation: il est obligatoire de respecter la distance minimum indiquée sur l'appareil, pour éviter que les objets illuminés, situés trop près de la source, atteignent des températures élevées.

IP 20

Index de protection IP 20. Protection contre l'entrée de corps solides de Ø ≥ 12 mm. Il n'y a aucune protection contre la pluie. Marquage non prévu sur l'appareil.



ATTENTION L'appareil ne doit pas être éliminé comme simple déchet urbain mais conformément à la collecte sélective pour garantir la protection de l'environnement. Conformément à la Directive 2002/96 et aux dispositions légales qui la transposent pour ce qui touche à l'élimination du produit au terme de sa durée de vie, les contrevenants aux dispositions en vigueur sont passibles des sanctions prévues par la loi. Veuillez vous informer du système local de séparation des déchets électriques et électroniques.

CARACTÉRISTIQUES TECHNIQUES

Alimentation de l'appareil: 230-240V 50Hz

	ICSELLE H1			
	Europe			U.S.A.
Type/puissance	E27 1x200W	E27 1x250W	E27 1x24W	E26 1xmax250W
ZWEI Code	A80	QT32	TC-SER	
ILCOS Code	IAA/C	HSGST/C	FBC	
U.S.A. Code				Halogen T10
L'ampoule	 H=123mm			
Distance minimum	0,5 m	0,5 m	0,2 m	

D

ALLGEMEINE SICHERHEITSAUWEISUNGEN



Austausch, Ein- und Ausbau sowie Bedienung der Lampe. Vor jedem Berühren stets den Netzstecker ziehen oder die Lampe vom Stromkreis entfernen. Bei Einrichtung von Hängeleuchten/Wandleuchten, wenden Sie sich immer an einen Elektrofachmann.



Den Kolben nicht mit den Fingern berühren; Fingerabdrücke verringern die Dauer und Leuchtkraft der Halogenlampe. Bei Berührung mit den Fingern, den Glaskolben mit einem weichen Tuch reinigen.



Wenn die Lampe eingeschaltet ist, kann der Glaskolben eine Temperatur bis zu 350°C erreichen, deswegen darf er nicht berührt werden und er muss vor dem Ersetzen erst abkühlen. Beim Einschalten kann es möglicherweise zu einer geringen und unbedeutenden Rauchbildung kommen. Reste von Öl (oder Rückstände von der Herstellung und Montage der Leuchte) verdunsten aufgrund der beträchtlichen Hitzeentwicklung des Leuchtmittels.



Stromleitende Teile dürfen nicht feucht werden. **Flächen wie Lampenschirme, Glas, Reflektoren und Abdeckungen können mit einem weichen Tuch ohne Reinigungsmittel gesäubert werden.** Die Lampe gegen Feuchtigkeit schützen.



Bei Austausch des Leuchtmittels ist darauf zu achten, dass die elektrischen Merkmale (Spannung in Volt, Leistung in W) den Angaben auf dem Kennschild der Leuchte entsprechen.

ZEICHEN



Klasse II. Gerät, bei dem sich der Schutz gegen Stromschläge nicht allein auf die Hauptisolierung, sondern auch auf zusätzliche Sicherungen stützt, die aus einer doppelten Isolierung oder verstärkter Isolierung bestehen. Diese Massnahmen umfassen keine Erdungsvorrichtungen und hängen nicht von den Einrichtungsbedingungen ab.



Geräte, die für die direkte Montage auf normalerweise entzündbaren Flächen vorbereitet sind. Maximale Temperatur auf der Stützfläche $T_{max} = 90^{\circ}C$



Mindestentfernung (in Metern) von den beleuchteten Gegenständen. Hinweis: es muss die auf dem Gerät angegebene Mindestentfernung eingehalten werden, um die starke Heizung der beleuchteten Gegenstände bei zu grosser Nähe zur Lichtquelle zu vermeiden.

IP 20

Schutzart IP 20. Schutz gegen das Eindringen fester Körper $\varnothing \geq 12$ mm. Kein Schutz gegen Regenwasser.









ACHTUNG Das Gerät darf nicht als unsortierter Siedlungsabfall entsorgt werden. Zum Schutz der Umwelt muss es getrennt einer Sammelstelle abgegeben werden. Gemäß der Richtlinie 2002/96 und den entsprechenden nationalen Gesetzen über die Entsorgung von Altgeräten ist die Nichteinhaltung strafbar. Bitte informieren Sie sich über die örtlichen Sammelstellen für Elektroprodukte und elektronische Geräte.

TECHNISCHE DATEN

Versorgung des Geräts: 230-240V 50Hz



	ICSELLE H1		
Type/Leistung	E27 1x200W	E27 1x250W	E27 1x24W
ZWEI Code	A80	QT32	TC-SER
ILCOS Code	IAA/C	HSGST/C	FBC
Lampe	 H=123mm		
Mindestentfernung	 0,5 m	 0,5 m	 0,2 m

E

INSTRUCCIONES DE MONTAJE Y USO



Instalación, mantenimiento del aparato y/o sustitución de la bombilla. Antes de llevar a cabo una operación cualquiera, desenchufar siempre la clavija de la toma de corriente o cortar la alimentación general de la instalación eléctrica. En caso de instalación de suspensiones/apliques, dirigirse siempre a personal cualificado.



No tocar la bombilla con los dedos: las huellas dactilares reducen la duración y la luminosidad de la bombilla halógena. En caso de contacto con los dedos, limpiar la ampolla de vidrio con un paño suave.



Cuando la bombilla está encendida, la ampolla de vidrio puede alcanzar temperaturas de hasta 350°C. Es totalmente necesario, por lo tanto, dejar que la lámpara se enfríe antes de sustituir las bombillas. Puede que, al encender la lámpara por vez primera, se advierta una ligera y poco importante formación de humo. Ciertos residuos, como el aceite u otros (resultantes de la fabricación y el montaje de la lámpara), se evaporan debido al notable calor creado por la bombilla.



Los componentes que conducen corriente no deberán entrar en contacto con la humedad. **Las superficies como pantallas, vidrios, reflectores y coberturas pueden limpiarse con un paño suave sin detergente.** Proteger la lámpara de la humedad durante el uso.



En caso de sustitución de la bombilla, prestar atención de modo que sus características eléctricas (voltaje en V, potencia en W) coincidan con los datos expresados en la placa de la lámpara.

SIMBOLOS



Clase II. Aparato en el que la protección contra la sacudida eléctrica no se basa únicamente en el aislamiento principal, sino también en medidas suplementarias de seguridad constituidas por el doble aislamiento o por el aislamiento reforzado.



Aparatos predispuestos para el montaje directo sobre superficies normalmente inflamables. Temperatura máxima en la base de apoyo $T_{máx.} = 90^{\circ}C$.



Distancia mínima en metros de los objetos iluminados. Nota: hay que respetar la distancia mínima indicada en el aparato, para evitar que los objetos iluminados, situados demasiado cerca de la fuente, alcancen temperaturas elevadas.

IP 20

Índice de protección IP 20. Protección contra la entrada de cuerpos sólidos de $\varnothing \geq 12$ mm. Ninguna protección contra la lluvia. No se ha previsto la marca en el aparato.









CUIDADO Este aparato no puede ser eliminado como desecho urbano. En efecto, debe ser desechado de modo diferenciado a fin de evitar daños al ambiente, de conformidad con lo establecido por la Directiva 2002/96 y por las leyes nacionales de transposición relativas a la eliminación de los productos que ya no pueden ser utilizados. La inobservancia de las normas citadas está penada por la ley. Deberá informarse sobre el sistema de reciclaje local separado para productos eléctricos y electrónicos.

CARACTERÍSTICAS TÉCNICAS

Alimentación del aparato: 230-240V 50Hz



	ICSELLE H1		
Type/energía	E27 1x200W	E27 1x250W	E27 1x24W
ZWEI Code	A80	QT32	TC-SER
ILCOS Code	IAA/C	HSGST/C	FBC
Bombilla	 H=123mm		
Distancia mínima	 0,5 m	 0,5 m	 0,2 m

S

ALLMÄNNA SÄKERHETSINSTRUKTIONER



Skruva på/av glödlampan samt allmänt underhåll: Innan något görs, koppla bort strömmen genom att ta bort stickproppen från uttaget alt se till att strömmen till lampen är avstängd.

Byte av glödlampa kan först göras när glödlamp svalnat. För enklare arbeten krävs nödig kännedom. Är Du osäker, anlita kvalificerad elektriker.



Rör inte glödlampan med Dina fingrar. Fingeravtryck kan förkorta livstiden samt försämma ljusstyrkan hos en halogenglödlampa. Har Du använt fingrarna, torka rent med en torr trasa.



När lampen lampen är tänd, kan en temperatur på upp till 350° C uppstå. Därför är det viktigt att glödlampan får svalna innan byte av glödlampa sker. När Du tänker lampen de första gångerna, kan lite rök uppstå. Det är små rester av olja från produktionen och monteringen och försvinner som är ofarlig. Inom kort har detta fenomen upphört.



Strömförande delar får inte komma i kontakt med fukt. **Ytor som glas, tygskärmar, reflektorer och skydd kan rengöras med en torr trasa, men använd inga tvål/tvättmedel.** Skydda lampen från fukt under användandet.



När Du byter glödlampa, kontrollera att glödlampa motsvarar den ljusstyrka (W) och strömstyrka (V) som avses.

FÖRKLARING TILL SYMBOLER



Klass II. Lampen har en mer omfattande skyddsnivå och behöver inte anslutas till jord.

Dubbelisolering och förstärkt isolering har utförts där så krävs.



Lampa som får monteras direkt mot normal brännbar yta. Max. temperatur mot ytan är 90° C.



Minsta tillåtna avstånd mellan glödlampa och brännbart material (i meter).

IP 20

Skyddsnivå IP 20. Skyddsnivån anger var lampen får användas någonstans. För badrum och utomhus gäller högre skyddsnivåer.









OBSERVERA Apparaten får inte nedskrotas som hushållsavfall. Den ska källsorteras för att undvika att skada omgivningen. I enlighet med Direktiv 2002/96 och de nationella lagarna angående avfallshantering är underlåtenhet att iakta ovannämnda anvisningar om nedskrotning av apparaten straffningsbart. Informera dig själv om lokala återvinnings och sophanteringssystem för elektriska och elektroniska produkter.

TEKNISKA EGENSKAPER

Apparatens matning: 230-240V 50Hz



	ICSELLE H1		
Type/power	E27 1x200W	E27 1x250W	E27 1x24W
ZWEI Code	A80	QT32	TC-SER
ILCOS Code	IAA/C	HSGST/C	FBC
Glödlampa	 H=123mm		
Minsta tillåtna	 0,5 m	 0,5 m	 0,2 m

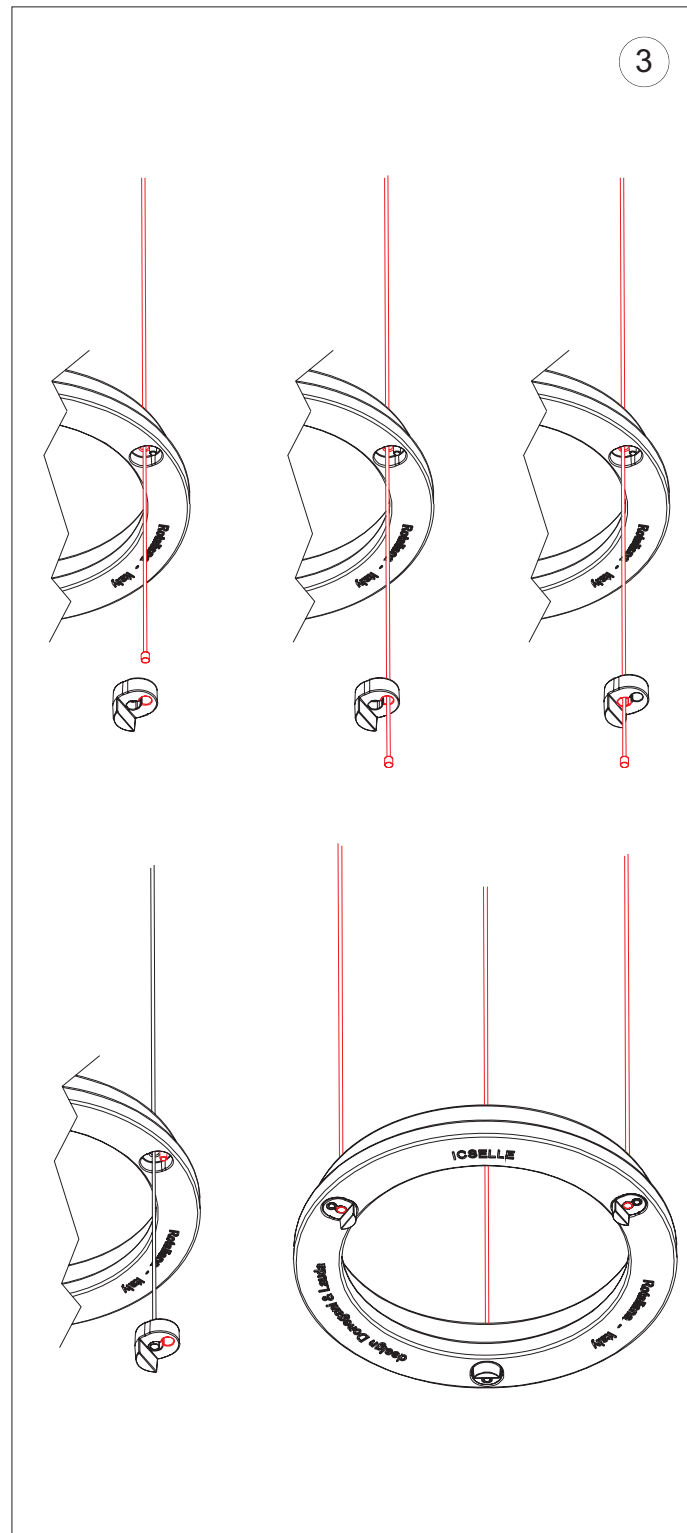
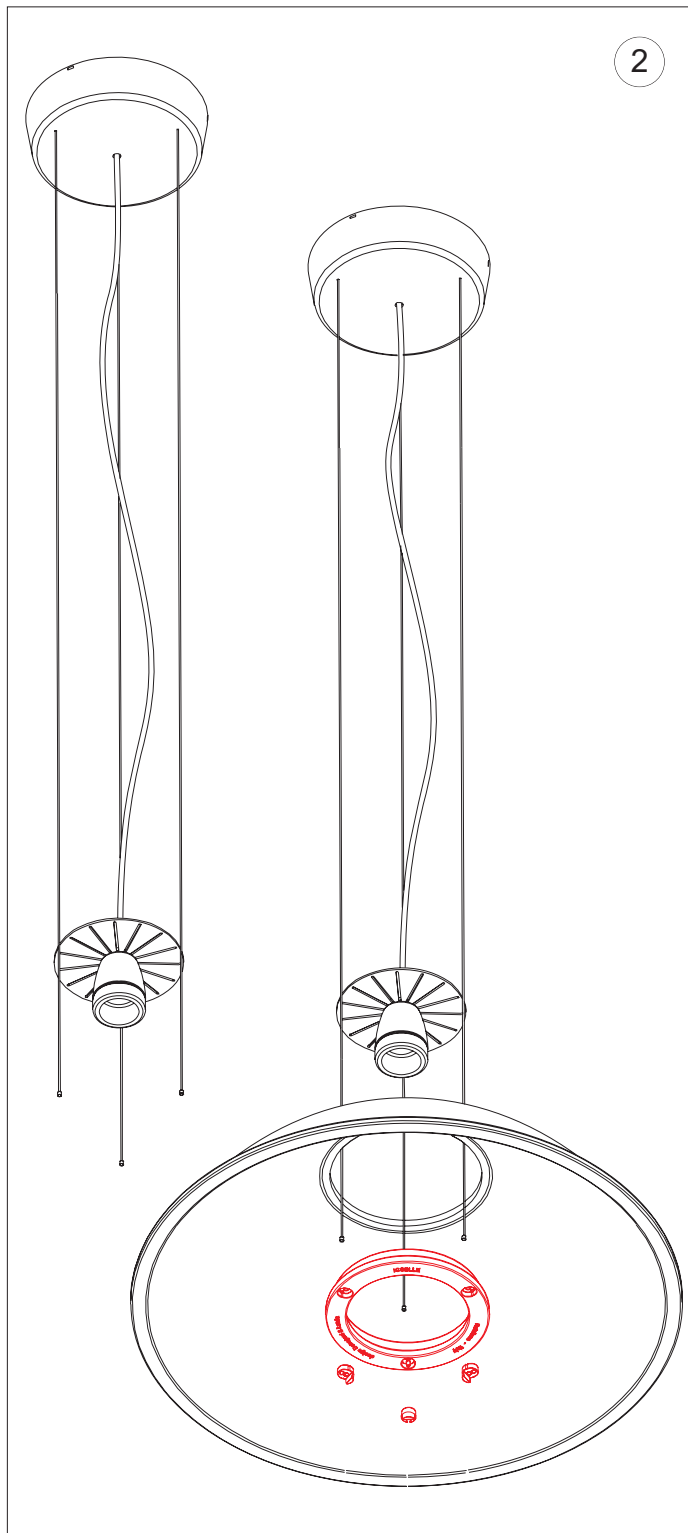
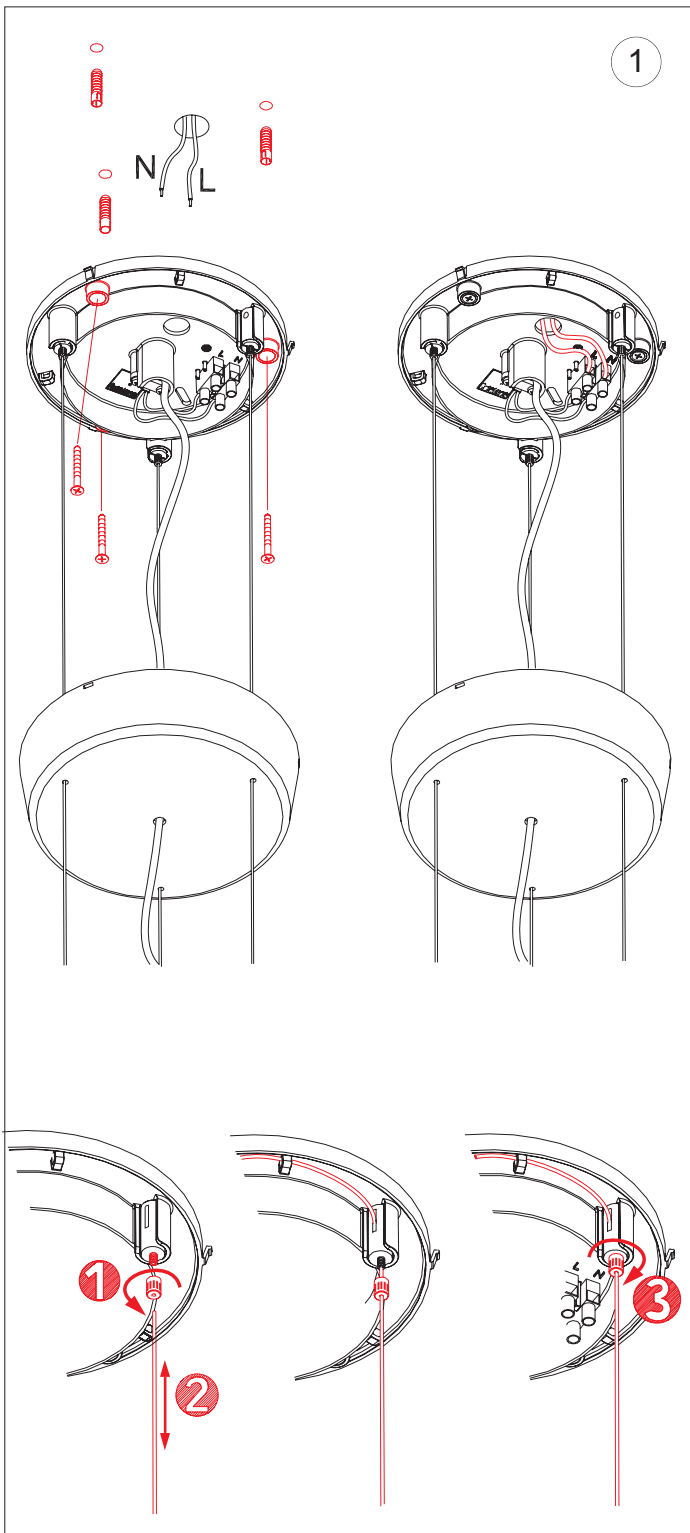

4

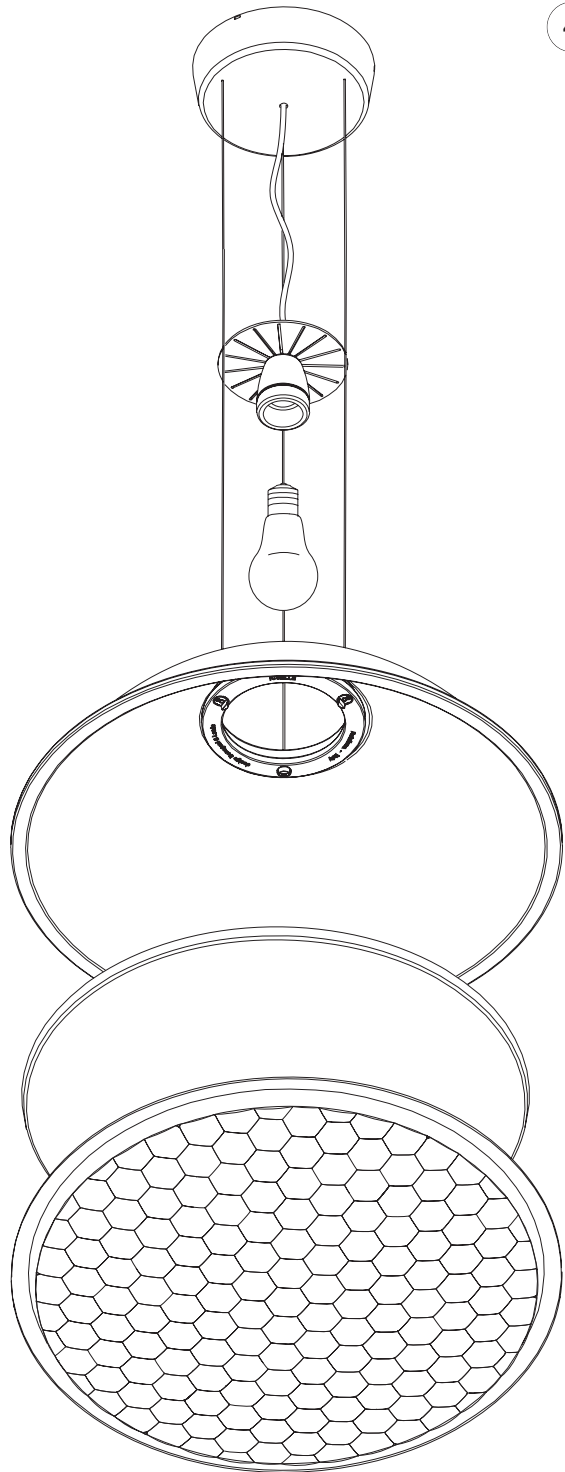

5

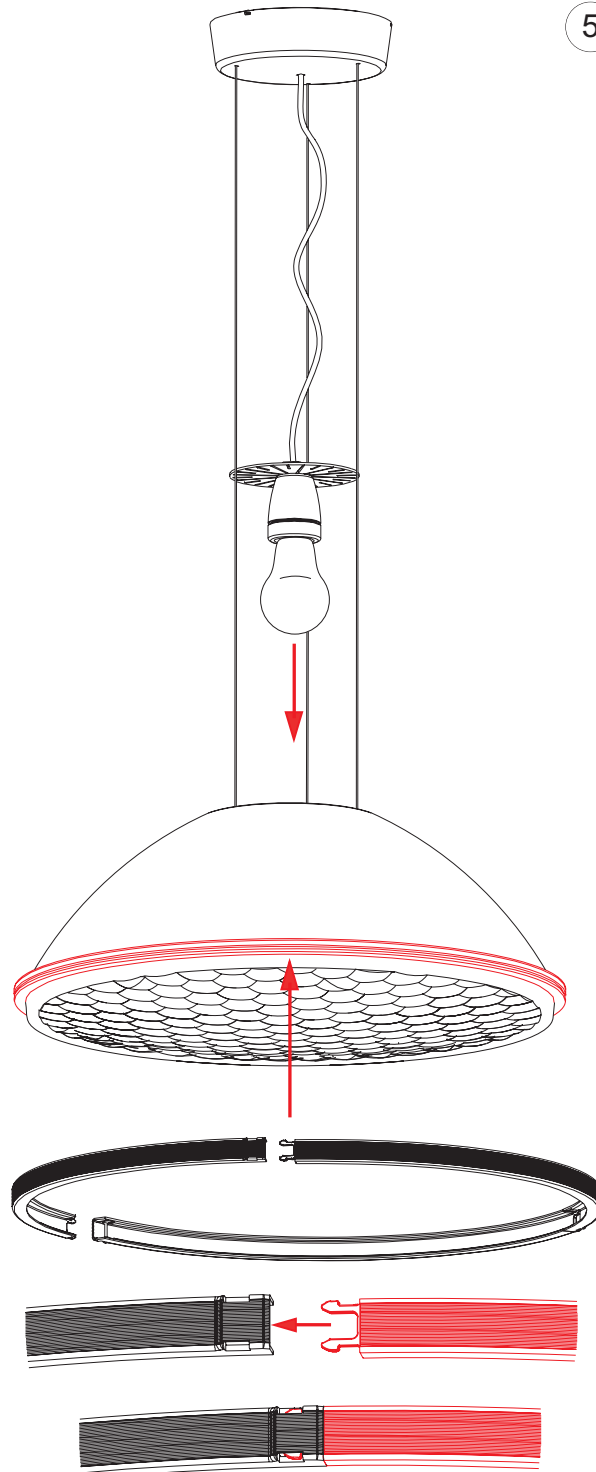

6

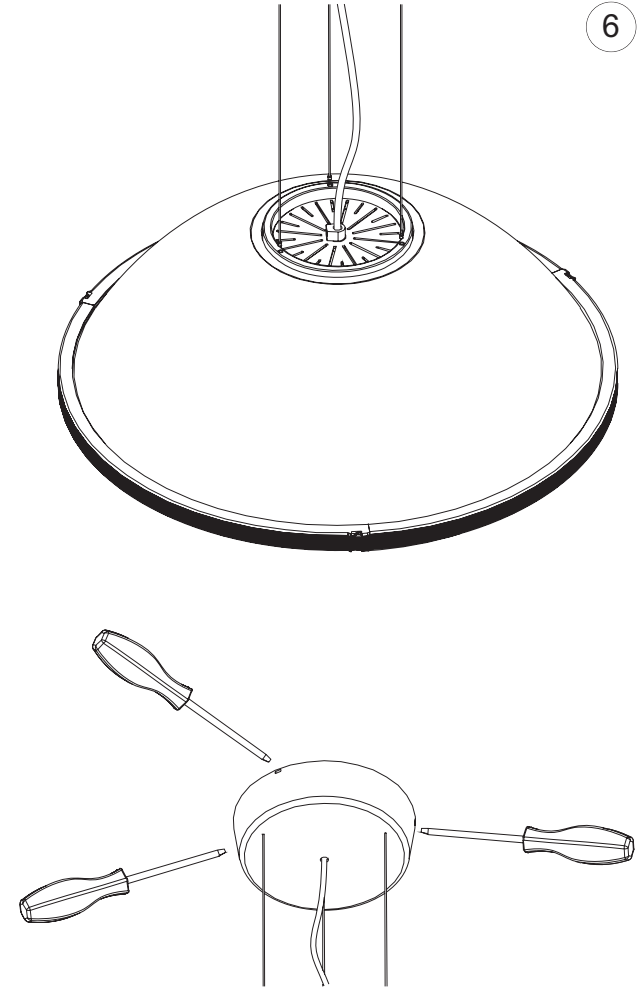

- ⓘ Per rimuovere l'anello tirare con forza
- ⓊK Pull hard to remove the ring
- ⓕ Tirer fort pour enlever l'anneau
- Ⓝ Zum Entfernen des Rings kräftig ziehen
- ⓔ Para quitar el anillo, tire con fuerza
- ⓈE Dra hårt i ringen för att ta bort den

