

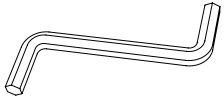

### Component List

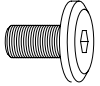

**A** - 4mm Hex Wrench  
x 1



**B** - 1/4-20 x 12mm Screw  
x 6

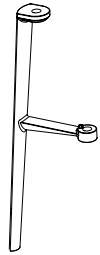

**C** - Leg x 3

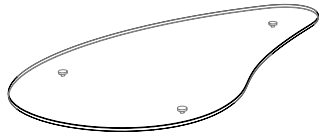

**D** - Glass Top x 1

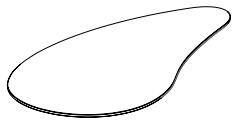

**E** - Glass Shelf x 1

Comma is engineered for easy assembly. Carefully follow this procedure to prevent any damage.

**NOTE:** This instruction sheet is intended for the entire Comma table collection; model 1533 is shown for illustration.

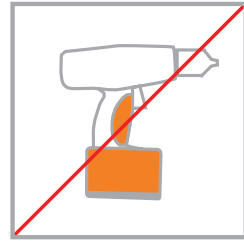

### Placement and Maintenance

Comma is designed for indoor use on level floors. Clean glass with glass cleaner and black coated metal with a moist cloth. Clean polished aluminum legs using a high-quality aluminum polish and follow its manufacturer's instructions. More frequent application of polish for cleaning will be required in coastal areas near salt water.

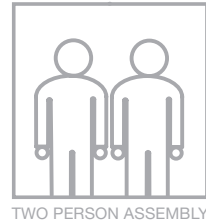

### Step 1

#### Unpack and Identify

Unpack and identify the components at left. The assembly workspace should be a non-marring surface such as carpet. For missing hardware pieces, please contact BDI Customer Service at customerservice@bdiusa.com. For all other concerns, please contact your BDI Retailer.

### Step 2

#### Attach Legs to Glass Shelf

Place **Glass Shelf (E)** on its **CONCAVE** edge on a soft surface in order to prevent damage. Attach **Legs (C)** to **Glass Shelf (E)** ensuring the tab of **Leg (C)** locks into the slot of the Glass Puck. Using **Hex Wrench (A)**, tighten **Screws (B)**. **DO NOT OVERTIGHTEN!**

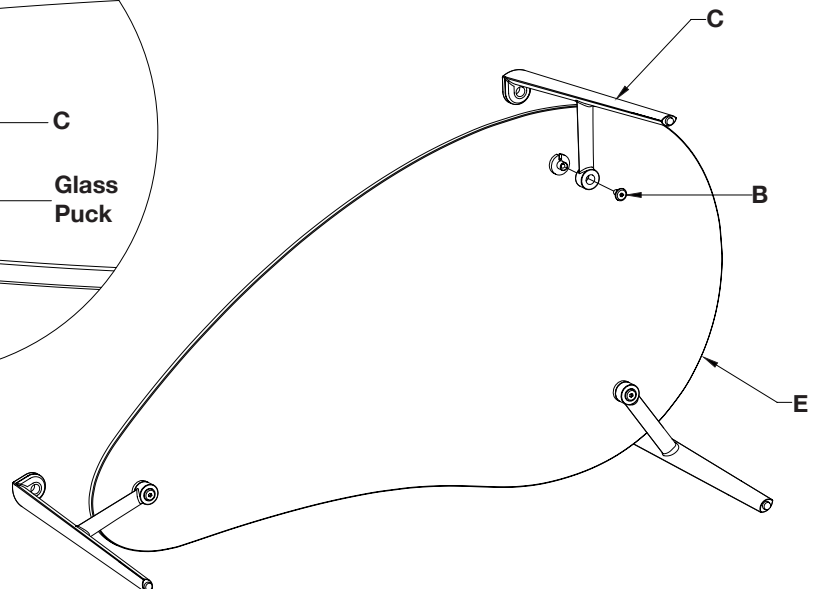
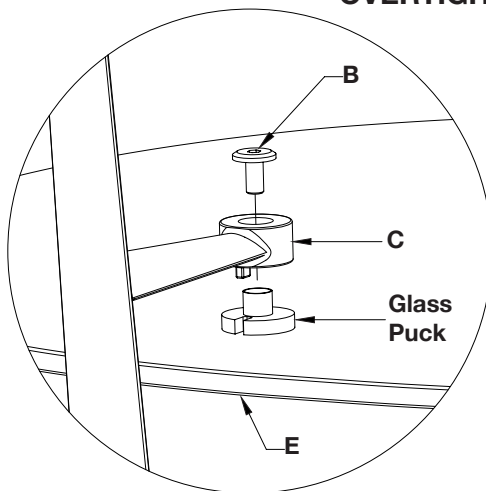

### Step 3

#### Attach Glass Top & Turn Table Over

With the **Glass Top (D)** upside down on a soft surface and the help of a second person, carefully lower the Shelf and Leg Assembly onto the **Glass Top (D)**, locating the holes of the **Legs (C)** onto the Glass Pucks. Loosely start all **Screws (B)** into Glass Pucks. After all **Screws (B)** are started, tighten using **Hex Wrench (A)**. **DO NOT OVERTIGHTEN!** Lifting by the table's **Legs (C)**, turn table over right side up.

