



OPERATOR'S MANUAL



<u>MODEL</u>	<u>ORDER #</u>
DE-201007D	1.106-061.0
DE-201507D	1.106-062.0
DE-301007D	1.106-063.0
DE-352007A	1.106-064.0

To locate your local Shark Commercial Pressure Washer Dealer nearest you,
visit www.shark-pw.com

8.919-015.0

CONTENTS

Important Safety Information	3-4
Component Identification	5
Assembly Instructions.....	6
Operating Instructions.....	7
Applying Detergents & General Cleaning Techniques	8
Shut Down and Clean-Up	9
Storage	9
Troubleshooting	10
Preventative Maintenance	11
Oil Change Record	11
Exploded View	12
Exploded View Parts List	13-14
Hose and Spray Gun Assembly.....	15
Unloader Exploded View and Parts List.....	16
Pump Exploded View and Parts List.....	17-18
Specifications.....	19
Warranty	20

Model Number _____

Serial Number _____

Date of Purchase _____

The model and serial numbers will be found on a decal attached to the pressure washer. You should record both serial number and date of purchase and keep in a safe place for future reference.

INTRODUCTION & IMPORTANT SAFETY INFORMATION

Thank you for purchasing this Pressure Washer. We reserve the right to make changes at any time without incurring any obligation.

Owner/User Responsibility:

The owner and/or user must have an understanding of the manufacturer's operating instructions and warnings before using this pressure washer. Warning information should be emphasized and understood. If the operator is not fluent in English, the manufacturer's instructions and warnings shall be read to and discussed with the operator in the operator's native language by the purchaser/owner, making sure that the operator comprehends its contents.

Owner and/or user must study and maintain for future reference the manufacturers' instructions.

The operator must know how to stop the machine quickly and understand the operation of all controls. Never permit anyone to operate the engine without proper instructions.

This manual should be considered a permanent part of the machine and should remain with it if machine is resold.

When ordering parts, please specify model and serial number. Use only identical replacement parts.

This machine is to be used only by trained operators.

IMPORTANT SAFETY INFORMATION

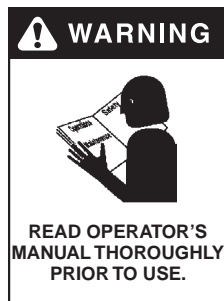

WARNING: To reduce the risk of injury, read operating instructions carefully before using.

1. Read the owner's manual thoroughly. Failure to follow instructions could cause malfunction of the machine and result in death, serious bodily injury and/or property damage.
2. Know how to stop the machine and bleed pressure quickly. Be thoroughly familiar with the controls.
3. Stay alert — watch what you are doing.
4. All installations must comply with local codes. Contact your electrician, plumber, utility company or the selling distributor for specific details. If your machine is rated 250 volts or less, single phase will be provided with a ground fault circuit interrupter (GFCI). If rated more than 250 volts, or more than single phase this product should only be connected to a power supply receptacle protected by a GFCI.

DANGER: Improper connection of the equipment-grounding conductor can result in a risk of electrocution. Check with a qualified electrician or service personnel if you are in doubt as to whether the outlet is properly grounded. Do not modify the plug provided with the product - if it will not fit the outlet, have a proper outlet installed by a qualified electrician. Do not use any type of adaptor with this product



WARNING: Keep wand, hose, and water spray away from electric wiring or fatal electric shock may result.

5. To protect the operator from electrical shock, the machine must be electrically grounded. It is the responsibility of the owner to connect this machine

to a UL grounded receptacle of proper voltage and amperage ratings. Do not spray water on or near electrical components. Do not touch machine with wet hands or while standing in water. Always disconnect power before servicing.



WARNING: Flammable liquids can create fumes which can ignite, causing property damage or severe injury.

WARNING: Risk of explosion — Do not spray flammable liquids.

6. Do not allow acids, caustic or abrasive fluids to pass through the pump.
7. Never run pump dry or leave spray gun closed longer than 1-2 minutes.
8. Keep operating area clear of all persons.



WARNING: High pressure spray can cause paint chips or other particles to become airborne and fly at high speeds. To avoid personal injury, eye, hand and foot safety devices must be worn.

9. Eye, hand, and foot protection must be worn when using this equipment.

IMPORTANT SAFETY INFORMATION

! WARNING



TRIGGER GUN KICKS BACK - HOLD WITH BOTH HANDS

WARNING: Grip cleaning wand securely with both hands before starting. Failure to do this could result in injury from a whipping wand.

! WARNING



RISK OF INJECTION OR SEVERE INJURY TO PERSONS. KEEP CLEAR OF NOZZLE.

WARNING: High pressure developed by these machines will cause personal injury or equipment damage. Keep clear of nozzle. Use caution when operating. Do not direct discharge stream at people, or severe injury or death will result.

10. To reduce the risk of injury, close supervision is necessary when a machine is used near children. Do not allow children to operate the pressure washer. **This machine must be attended during operation.**
11. Never make adjustments on machine while in operation.
12. Be certain all quick coupler fittings are secured before using pressure washer.

! WARNING



PROTECT FROM FREEZING

WARNING: Protect machine from freezing.

13. To keep machine in best operating conditions, it is important you protect machine from freezing. Failure to protect machine from freezing could cause malfunction of the machine and result in death,

serious bodily injury, and/or property damage. Follow storage instructions specified in this manual.

14. Inlet water must be clean fresh water and no hotter than 90°F.
15. Manufacturer will not be liable for any changes made to our standard machines or any components not purchased from us.
16. The best insurance against an accident is precaution and knowledge of the machine.

! WARNING



RISK OF INJURY FROM FALLS WHEN USING LADDER.

WARNING: Be extremely careful when using a ladder, scaffolding or any other relatively unstable location. The cleaning area should have adequate slopes and drainage to reduce the possibility of a fall due to slippery surfaces.

17. Do not overreach or stand on unstable support. Keep good footing and balance at all times.
18. Do not operate this machine when fatigued or under the influence of alcohol, prescription medications, or drugs.



Follow the maintenance instructions specified in the manual.

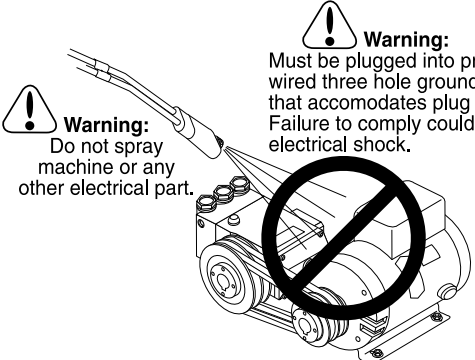

! Warning: Must be plugged into properly wired three hole grounded outlet that accommodates plug on power cord. Failure to comply could result in electrical shock.

! Warning: Do not spray machine or any other electrical part.

COMPONENT IDENTIFICATION

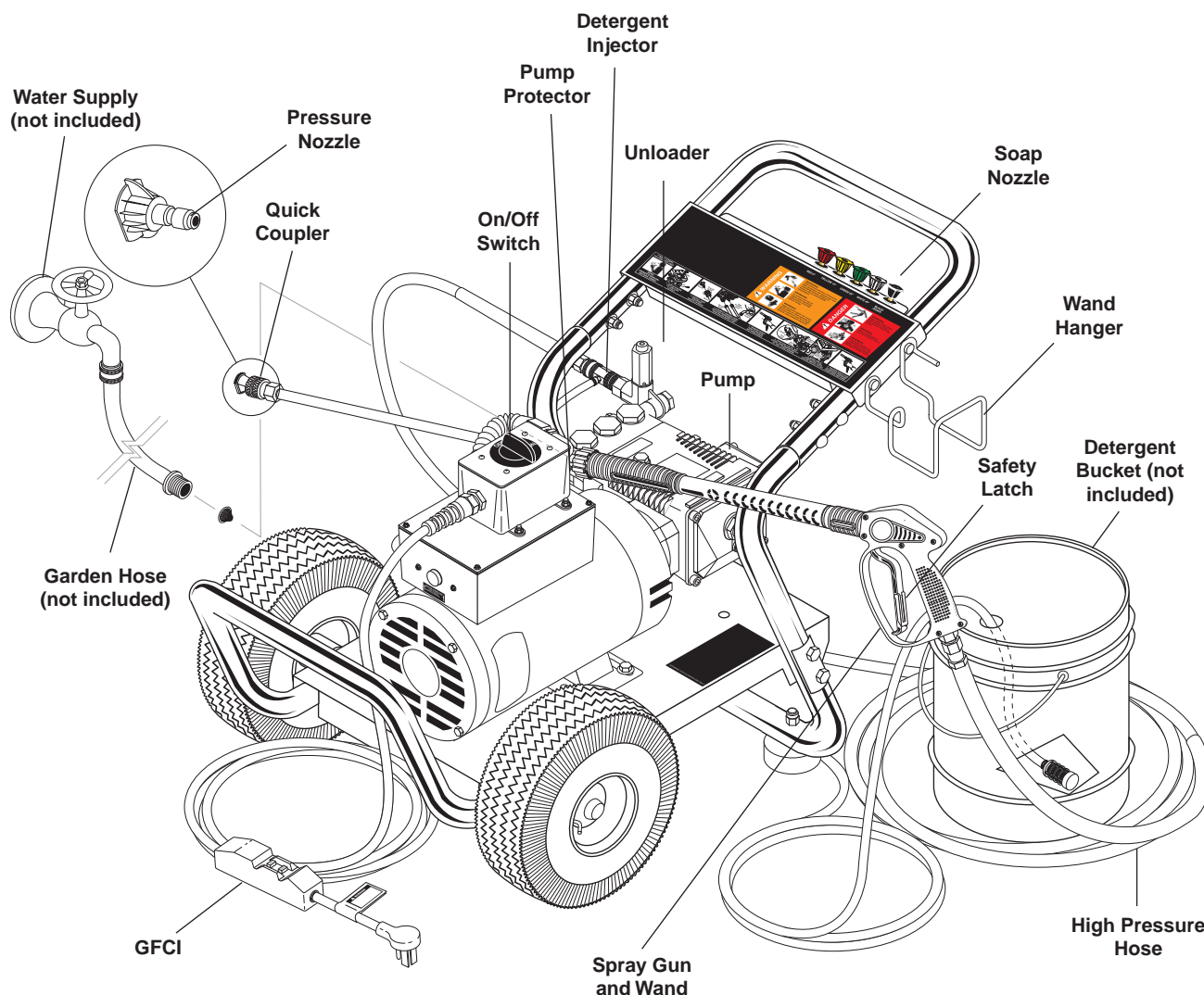

Pump — Develops high pressure.

Spray Gun — Controls the application of water and detergent onto cleaning surface with trigger device. Includes safety latch.

Detergent Injector — Allows you to siphon and mix detergents when used with a soap nozzle.

Wand — Must be connected to the spray gun.

Unloader — Safety device that relieves pressure when spray gun trigger is closed.

High Pressure Hose — Connect one end to water pump discharge nipple and the other end to spray gun.

Pump Protector — Cycles fresh cool water through pump when recirculating water reaches 140°F.

GFCI — Ground fault circuit interrupter trips when voltage leaks to ground.

Note: If trigger on spray gun is released for more than 2 minutes, water will leak from valve. Warm water will discharge from pump protector onto floor. This system prevents internal pump damage.

ASSEMBLY INSTRUCTIONS

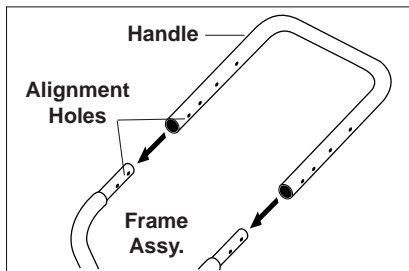

STEP 1: Attach handle to the frame of the pressure washer. **Note:** It may be necessary to move the handle supports from side to side in order to align the handle so it will slide over the frame supports.

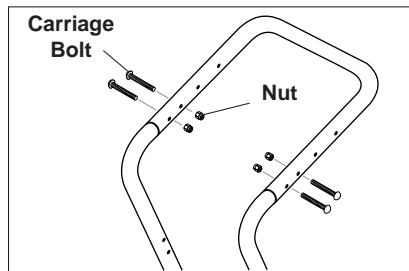

STEP 2: Insert the carriage bolt through the holes from the outside of the unit and attach a nut from the inside of the machine. Tighten nuts.

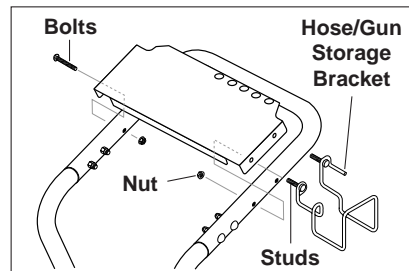

STEP 3: Attach the spray gun/hose storage bracket, and bracket to handle. Tighten nuts.

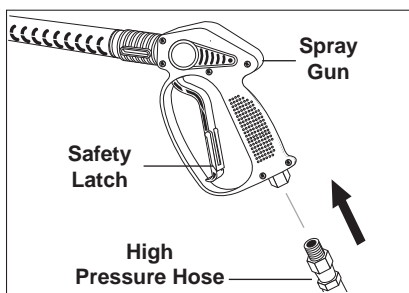

STEP 4: Attach the high pressure hose to the spray gun using teflon tape on hose threads.

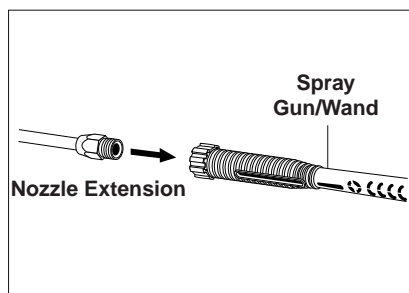

STEP 5: Attach nozzle extension to spray gun/wand. Tighten both by hand.

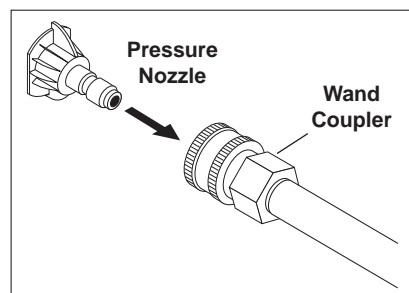

STEP 6: Pull the spring-loaded collar of the wand coupler back to insert your choice of pressure nozzle.

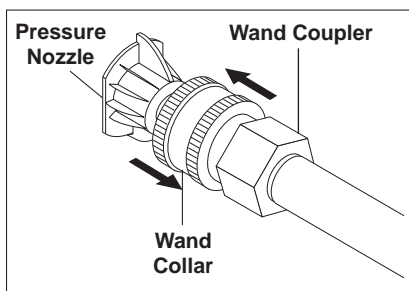

STEP 7: Release the coupler collar and push the nozzle until the collar clicks. Pull the nozzle to make sure it is seated properly.

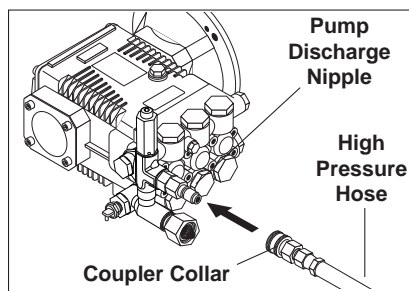

STEP 8: Connect the high pressure hose to the pump discharge nipple. Push coupler collar forward until secure.

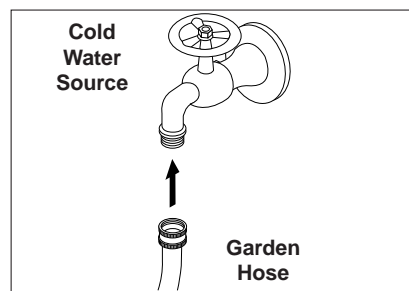

STEP 9: Connect garden hose to the cold water source.

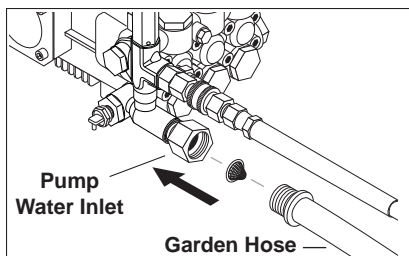

STEP 10: Connect the garden hose to pump water inlet. Inspect inlets. **CAUTION: Do not run the pump without water or pump damage will result.**

OPERATING INSTRUCTIONS

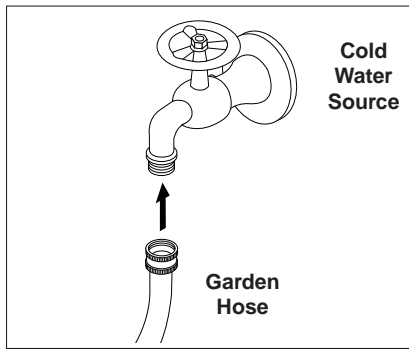

STEP 1: Connect garden hose to the cold water source and turn water on completely. Never use hot water.

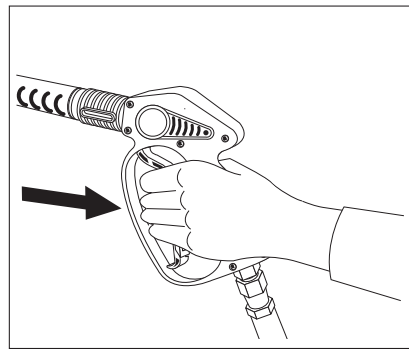

STEP 2: Trigger the spray gun to eliminate trapped air then wait for a steady flow of water to emerge from the spray nozzle.

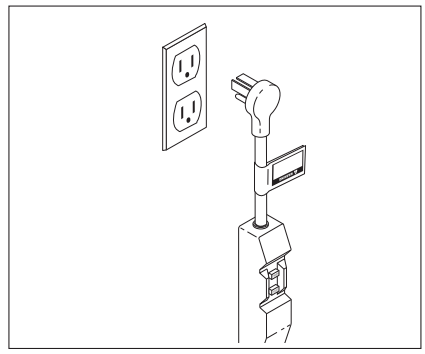

STEP 3: Connect to appropriate power supply. Push reset button on GFCI.

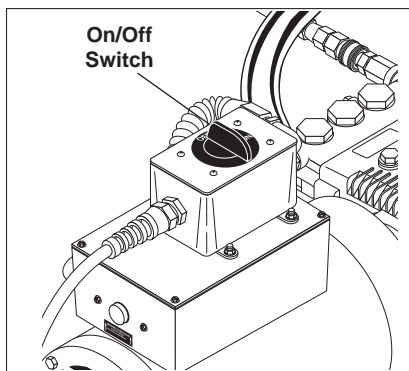

STEP 4: Turn machine on by turning switch at top of motor.

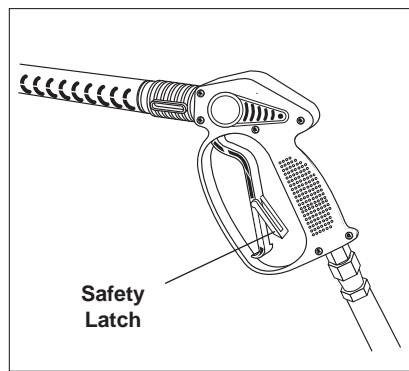

WARNING! Never replace nozzles without engaging the safety latch on the spray gun trigger.



The five color-coded quick connect nozzles provide a wide array of spray widths from 0° to 40° and are easily accessible when placed in the convenient rubber nozzle holder, which is provided on the front of the machine.

NOTE: For a more gentle rinse, select the white 40° or green 25° nozzle. To scour the surface, select the yellow 15° or red 0° nozzle. To apply detergent select the black nozzle.

DETERGENTS & GENERAL CLEANING TECHNIQUES

WARNING

WARNING: Some detergents may be harmful if inhaled or ingested, causing severe nausea, fainting or poisoning. The harmful elements may cause property damage or severe injury.



STEP 1: Connect detergent injector to discharge nipple on machine. Connect high pressure hose to injector with quick coupler. (Check to make sure locking coupler sleeves are in proper position before applying water pressure).

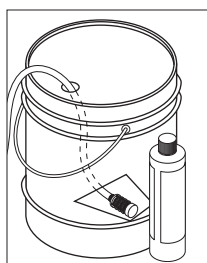
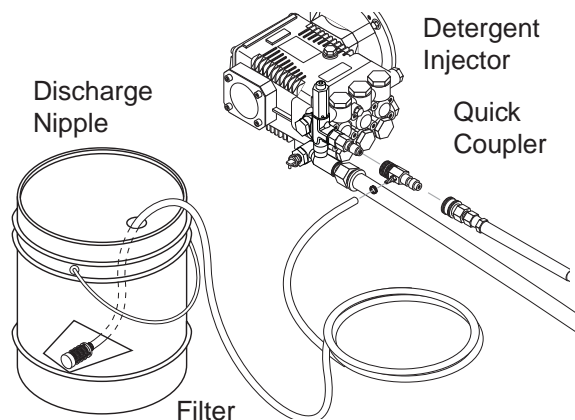

STEP 2: Use detergent designed specifically for pressure washers. Household detergents could damage the pump. Prepare detergent solution as required by the manufacturer. Fill a container with pressure washer detergent. Place the filter end of detergent suction tube into the detergent container.

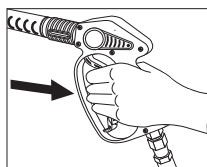

STEP 3: With safety latch on spray gun engaged, secure black detergent nozzle into quick coupler. **NOTE:** Detergent cannot be applied using a pressure nozzle.

STEP 4: With the motor running, pull trigger to operate machine. Liquid detergent is drawn into the machine and mixed with water. Apply detergent to work area. Do not allow detergent to dry on surface.

IMPORTANT: You must flush the detergent injection system after each use by placing the suction tube into a bucket of clean water, then run the pressure washer in low pressure for 1-2 minutes.

THERMAL PUMP PROTECTION

If you run the motor on your pressure washer for 3-5 minutes without pressing the trigger on the spray gun, circulating water in the pump can reach high temperatures. When the water reaches this temperature, the pump protector engages and cools the pump by discharging the warm water onto the ground. This thermal device prevents internal damage to the pump.

CLEANING TIPS

Pre-rinse cleaning surface with fresh water. Place detergent suction tube directly into cleaning solution and apply to surface at low pressure (for best results, limit your work area to sections approximately 6' square and always apply detergent from bottom to top). Allow detergent to remain on surface 1-3 minutes. Do not allow detergent to dry on surface. If surface appears to be drying, simply wet down surface with fresh water. If needed, use brush to remove stubborn dirt. Rinse at high pressure from top to bottom in an even sweeping motion keeping the spray nozzle approximately 1' from cleaning surface. Use overlapping strokes as you clean and rinse any surface. For best surface cleaning action spray at a slight angle.

Recommendations:

- Before cleaning any surface, an inconspicuous area should be cleaned to test spray pattern and distance for maximum cleaning results.
- If painted surfaces are peeling or chipping, use extreme caution as pressure washer may remove the loose paint from the surface.
- Keep the spray nozzle a safe distance from the surface you plan to clean. High pressure wash a small area, then check the surface for damage. If no damage is found, continue to pressure washing.

CAUTION - Never use:

- Bleach, chlorine products or other corrosive chemicals
- Liquids containing solvents (i.e., paint thinner, gasoline, oils)
- Tri-sodium phosphate products
- Ammonia products
- Acid-based products

These chemicals will harm the machine and will damage the surface being cleaned.

RINSING

It will take a few seconds for the detergent to clear. Apply safety latch to spray gun. Remove black soap nozzle from the quick coupler. Select and install the desired high pressure nozzle. **NOTE:** You can also stop detergent from flowing by simply removing detergent siphon tube from bottle.

SHUTTING DOWN AND CLEAN-UP

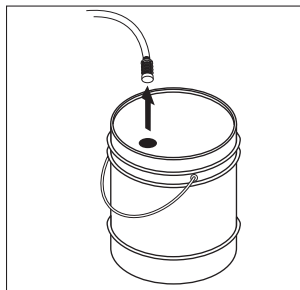

STEP 1: Remove detergent suction tube from container and insert into one gallon of fresh water. Slide nozzle forward for low pressure or use black detergent nozzle. Pull trigger on spray gun and siphon fresh clean water for one minute.

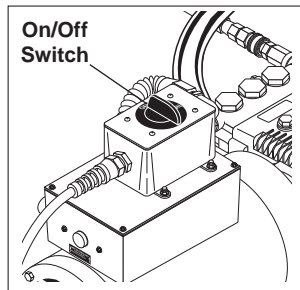

STEP 2: Turn off machine by turning switch to "OFF" switch.

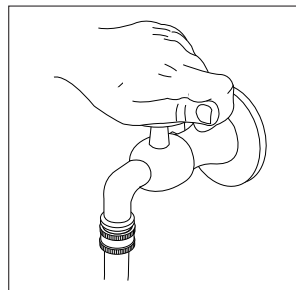

STEP 3: Turn off water supply.

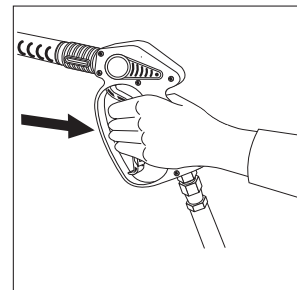

STEP 4: Press trigger to release water pressure.

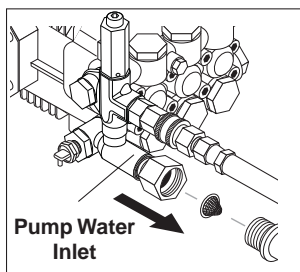

STEP 5: Disconnect the garden hose from the water inlet on the machine.

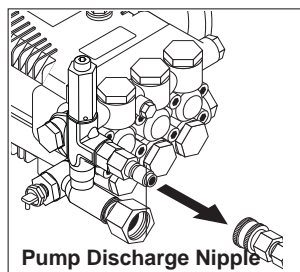

STEP 6: Disconnect the high pressure hose from pump discharge nipple.

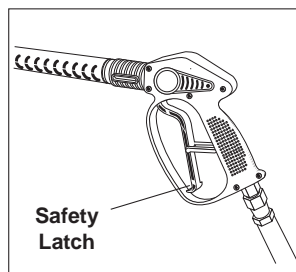

STEP 7: Engage the spray gun safety lock.

STORAGE

Pump Storage



CAUTION: Always store your pressure washer in a location where the temperature will not fall below 32°F (0°C). The pump in this machine is susceptible to permanent damage if frozen.

FREEZE DAMAGE IS NOT COVERED BY WARRANTY.

If you must store your pressure washer in a location where the temperature is below 32°F, you can minimize the chance of damage to your machine by draining your machine as follows:

1. Stop the pressure washer and detach supply hose and high pressure hose. Squeeze trigger of spray gun to drain all water from the wand and hose.
2. Restart pressure washer and let it run briefly (about 5 seconds) until water no longer discharges from the high pressure outlet.

TROUBLESHOOTING

PROBLEM	POSSIBLE CAUSE	SOLUTION
PUMP RUNNING NORMALLY BUT PRESSURE LOW ON INSTALLATION	Pump sucking air	Check water supply and possibility of air.
	Check valves sticking	Check and clean or replace if necessary.
	Unloader valve seat faulty	Check and replace if necessary.
	Nozzle incorrectly sized	Check and replace if necessary.
	Worn piston packing	Check and replace if necessary.
FLUCTUATING PRES-SURE	Valves worn	Check and replace if necessary.
	Blockage in valve	Check and replace if necessary.
	Pump sucking air	Check water supply connections.
	Worn piston packing	Check and replace if necessary.
	Insufficient water	Check filter and hose for breakage.
PRESSURE LOW AFTER PERIOD OF NORMAL USE	Nozzle worn	Check and replace if necessary.
	Suction or delivery valves worn	Check and replace if necessary.
	Suction or delivery lines blocked	Check and clean if necessary.
	Unloader valve seat worn	Check and replace if necessary.
	Worn piston packing	Check and replace if necessary.
	Water temperature excessive	Reduce to below 160° F.
PUMP NOISY	Air in suction line	Check water supply and connections on suc-tion line.
	Broken or weak suction or delivery valve spring	Check and replace if necessary.
	Foreign matter in valves	Check and clean if necessary.
	Worn bearings	Check and replace if necessary.
	Excessive temperature of water	Reduce to below 160° F.
PRESENCE OF WATER IN PUMP OIL	Oil seal worn	Check and replace if necessary.
	High humidity in air	Check and replace if necessary.
	Piston packing worn	Check and replace if necessary.
WATER DRIPPING FROM UNDER PUMP	Piston packing worn	Check and replace if necessary.
	O-ring plunger retainer worn	Check and replace if necessary.
WATER DRIPPING FROM PUMP PROTECTOR	Water supply pressure too high (over 90 PSI)	Lower water supply pressure using a regula-tor.
	Spray gun is in the off position for over 5 minutes	Turn machine off if not in use for over 5 min-utes.
OIL DRIPPING	Oil seal worn	Check and replace if necessary.
EXCESSIVE VIBRATION IN HIGH PRESSURE HOSE	Irregular functioning of the pump valves	Check and replace if necessary.
MOTOR DOES NOT START WHEN SWITCHED ON	Plug not well connected or lack of power supply	Check plug, cable and switch.
WHEN SWITCHING ON THE MACHINE, MOTOR HUMS BUT DOES NOT RUN	Main voltage is insufficient lower than the minimum required	Check to make sure main power supply is adequate.
	The pump is stuck or frozen	Check by turning the motor manually.
MOTOR STOPS	Tripped thermal overload due to over-heating	Check that main voltage corresponds to the specifications. Wait a few minutes before turn-ing on the machine again by resetting the GFCI cord.

PREVENTATIVE MAINTENANCE

PREVENTATIVE MAINTENANCE

This pressure washer was produced with the best available materials and quality craftsmanship. However, you as the owner have certain responsibilities for the correct care of the equipment. Attention to regular preventative maintenance procedures will assist in preserving the performance of your equipment. Contact your dealer for maintenance. Regular preventative maintenance will add many hours to the life of your pressure washer. Perform maintenance more often under severe conditions.

MAINTENANCE SCHEDULE		
Pump Oil	Inspect	Daily inspect the oil level
	Change	After first 50 hours, then every 500 hours or annually
Replace High Pressure Nozzle		Every 6 months
Replace Quick Connects		Annually
Clean Water Screen/Filter		Weekly
Replace HP Hose		Annually if there is any sign of wear
Grease Motor		Every 10,000 hours

OIL CHANGE RECORD

Check pump oil and engine oil level before first use of your new pressure washer.

Date Oil Changed Month/Day/Year	Estimated Operating Hours Since Last Oil Change

Date Oil Changed Month/Day/Year	Estimated Operating Hours Since Last Oil Change

EXPLODED VIEW

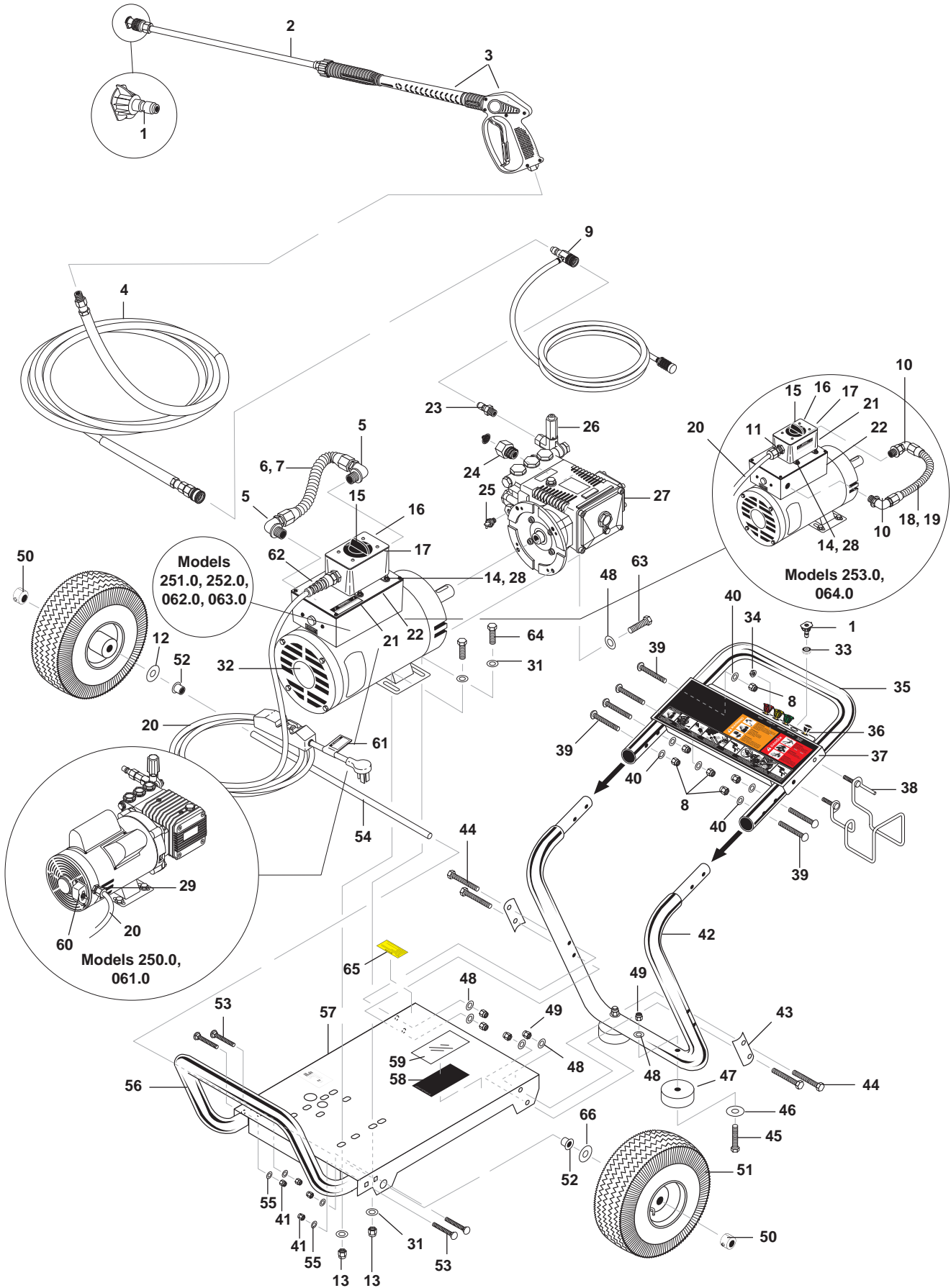

EXPLODED VIEW PARTS LIST

ITEM	PART NO.	DESCRIPTION	QTY	ITEM	PART NO.	DESCRIPTION	QTY
1	9.104-016.0	NOZZLE KIT 3.25 (23326)	1	16	9.802-478.0	Lid, Plastic, Carlon E9801 Box (251.0, 252.0, 253.0, 062.0, 063.0, 064.0)	1
	9.804-624.0	Nozzle, 1504, Yellow (250.0, 061.0)	1	17	9.802-477.0	Box, Plastic, Carlon E9801, w/o Lid (251.0, 252.0, 253.0, 062.0, 063.0, 064.0)	1
	9.804-625.0	Nozzle, 2504, Green (250.0, 061.0)	1	18	9.802-436.0	Cord, Service, 10/3 (253.0, 064.0)	21"
	9.804-626.0	Nozzle, 4004, White (250.0, 061.0)	1	19	9.803-832.0	Conduit, Water Tite, Flex 3/4" (253.0, 064.0)	8"
	9.804-627.0	Nozzle, 0004, Red (250.0, 061.0)	1	20	9.802-430.0	GFCI, 240V1Ph30A, 36' 10-3 Cord (253.0, 064.0)	1
	8.712-354.0	Nozzle, 1505, Yellow (253.0, 064.0)	1		9.802-431.0	GFCI, 120V 20A, w/36' 12-3 Cord (251.0, 252.0, 062.0, 063.0)	1
	8.712-365.0	Nozzle, 2505, Green (253.0, 064.0)	1		9.802-432.0	GFCI, 120V 15A, w/36' 12-3 Cord (250.0, 061.0)	1
	8.712-366.0	Nozzle, 4005, White (253.0, 064.0)	1	21	9.800-016.0	Label, Disconnect Power Supply	1
	8.712-363.0	Nozzle, 0005, Red (253.0, 064.0)	1	22	9.803-833.0	Cover, Motor (251.0, 252.0, 253.0, 062.0, 063.0, 064.0)	1
	8.712-358.0	Nozzle, 1555, Yellow (252.0, 063.0)	1	23	9.802-171.0	Nipple 3/8" x 3/8" NPT Male	1
	8.712-359.0	Nozzle, 2555, Green (252.0, 063.0)	1	24	9.802-146.0	Swivel, 1/2" MP x 3/4" GHF, w/ Strainer	1
	8.712-360.0	Nozzle, 4055, White (252.0, 063.0)	1	25	8.707-256.0	Protector, Pump 1/2" 140°	1
	8.712-357.0	Nozzle, 0055, Red (252.0, 063.0)	1	26		Unloader, See Specifications Page	
	8.712-398.0	Nozzle, Compl. QCME 6540, Brass, All	1	27		Pump, See Specifications Page	
2	9.802-220.0	Wand, 18" M22 x 1/4" QC	1	28	9.802-695.0	Nut, 10/32" Keps (251.0, 252.0, 253.0, 062.0, 063.0, 064.0)	4
3	9.802-223.0	Spray Gun, SK@, 3/8" Inlet	1	29	9.802-514.0	Strain Relief (250.0, 061.0)	1
4		Hose, See Specifications Page			9.802-525.0	▲ Locknut, 1/2" (250.0, 061.0)	1
5	9.802-517.0	Connector, 1/2" L/T, 90°, Black (251.0, 252.0, 062.0, 063.0)	2	30	9.802-695.0	▲ Nut, 10/32" Keps (251.0, 252.0, 253.0, 062.0, 063.0, 064.0)	3
6	9.802-427.0	Cord, Service, SOWA 12/3, Coleman (251.0, 252.0, 062.0, 063.0)	21"		9.802-699.0	▲ Screw, 10/32" x 3/4" Slot Pan, MS, SS (251.0, 252.0, 253.0, 062.0, 063.0, 064.0)	1
7	9.802-448.0	Conduit, Watertight, Flex, 1/2" (251.0, 252.0, 062.0, 063.0)	8"		9.800-040.0	▲ Label, Ground (251.0, 252.0, 253.0, 062.0, 063.0, 064.0) (250.0, 061.0)	2
8	9.802-773.0	Nut, 1/4" ESNA, NC	6				1
9	9.802-225.0	Injector, Detergent, Assy, 3-5 GPM	1	31	8.718-980.0	Washer, 5/16" Flat	8
10	9.803-831.0	Connector, 3/4" L/T, 90°, Black (253.0, 064.0)	2	32		Motor, See Specifications Page	
11	9.802-518.0	Strain Relief, 3/4" (253.0, 064.0)	1	33	9.802-064.0	Grommet, Rubber, Nozzle Holder	5
	9.802-523.0	▲ Locknut, 3/4" (253.0, 064.0)	1	34	9.802-778.0	Nut, 5/16" Flange, Whiz Loc	2
12	9.802-810.0	Washer, 5/8" Flat	2	35	9.803-122.0	Handle, Grab, Chrome	1
13	9.802-776.0	Nut, 5/16" ESNA	4	36	9.800-062.0	Label (HD)	1
14	9.802-759.0	Screw, 10/32" x 1/2" BHSOC, Black (251.0, 252.0, 253.0, 062.0, 063.0, 064.0)	4		8.900-912.0	Label (DE)	1
15	9.802-450.0	Switch, 2 Pos. 120V-600V, 1-3 PH Brema (251.0, 252.0, 253.0, 062.0, 063.0, 064.0)	1	37	9.803-126.0	Plate, Warning/Instr. Black	1
				38	9.803-098.0	Hanger, Hose/Wand	1

EXPLODED VIEW PARTS LIST

ITEM	PART NO.	DESCRIPTION	QTY
39	9.802-706.0	Bolt, Carriage, 1/4"-20 x 1-3/4"	6
40	9.802-802.0	Washer, 1/4" Flat	6
41	9.802-776.0	Nut, 5/16" ESNA, NC	4
42	9.803-119.0	Handle, Lower Grab, Chrome	1
43	9.803-114.0	Retainer Bracket, Handle, Black	2
44	9.802-728.0	Bolt, 3/8" x 2"	4
45	9.802-730.0	Bolt, 3/8" x 2-1/2"	2
46	9.802-817.0	Washer, 3/8" x 1"	2
47	9.802-066.0	Pad, Soft Rubber, 50 Duro	2
48	9.802-807.0	Washer, 3/8" SAE, Flat	10
49	9.802-779.0	Nut, 3/8" ESNA, NC	6
50	9.802-782.0	Axle Hub Black	2
51	9.802-270.0	Wheel & Tire Assy., 4" Steel Rim w/Tube	2
52	9.802-103.0	Bushing, Snap, 5/8"	2
53	9.802-712.0	Bolt, Carriage 5/16" x 1-3/4"	4
54	9.803-097.0	Axle, 5/8" x 19.625" Long	1
55	9.802-807.0	Washer, 5/16" Flat, SAE	4
56	9.803-123.0	Handle, Bumper, Chrome	1
57	9.803-125.0	Base, CW Direct, Black	1
58	9.800-013.0	Label, Intended For Indoor Use	1
59	9.800-034.0	Label, Clear Lexan, 2-1/4" x 4-1/2"	1
60	9.802-454.0	Switch Assembly (250.0, 061.0)	1
61	8.932-969.0	Label, Warning, Service Cord	1
62	9.802-516.0	Strain Relief, Flex 90°, Plastic (251.0, 252.0, 062.0, 063.0)	1
	9.803-834.0	▲ Washer, 3/4" x 1/2" Reducing (251.0, 252.0, 062.0, 063.0)	1
63	9.802-720.0	Bolt, 3/8" x 1" NC HH	4
64	8.718-618.0	Bolt, 5/16" x 3/4" NC, Grade 5	4
65	9.800-049.0	Label, Manufacturer's Cleaning Solution	1

▲ Not Shown

HOSE AND SPRAY GUN ASSEMBLY

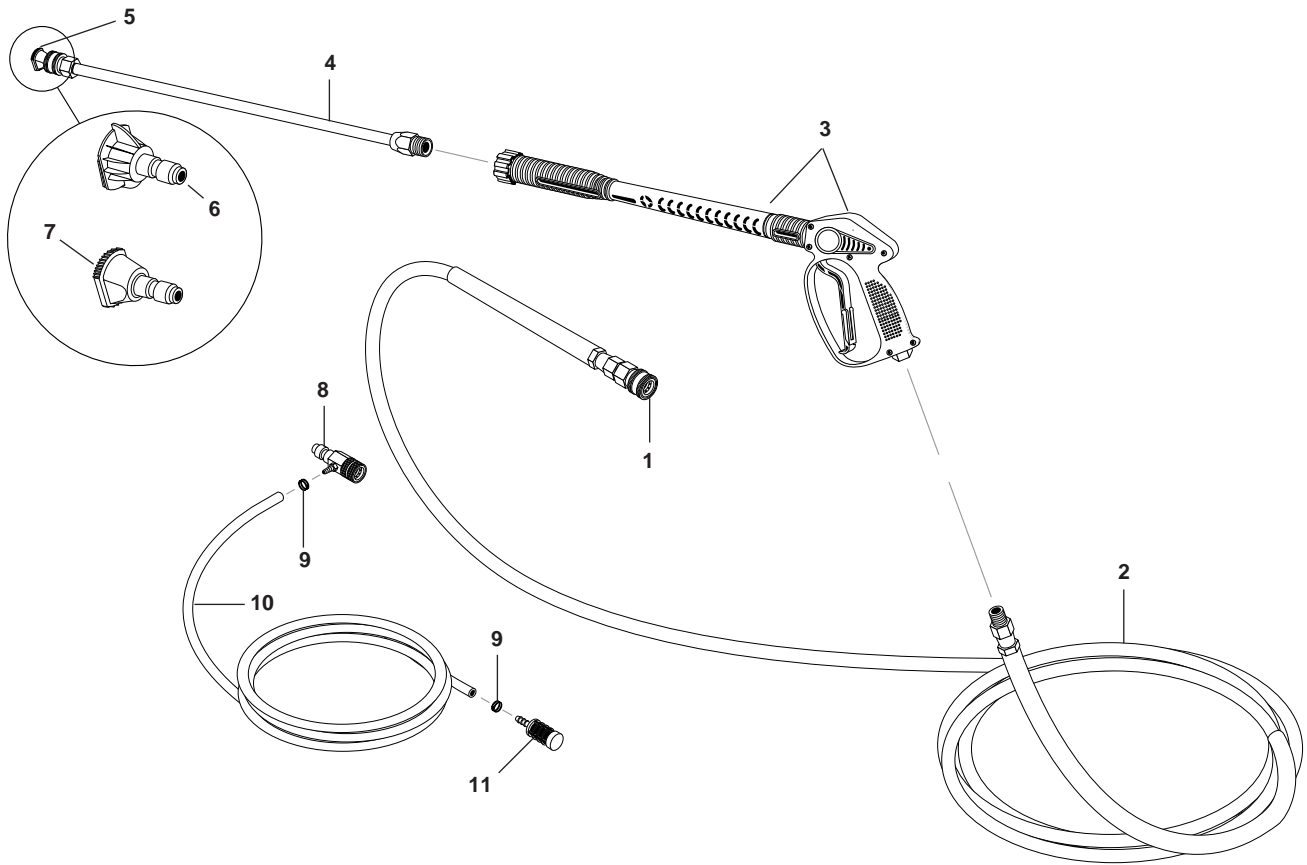

HOSE AND SPRAY GUN ASSEMBLY PARTS LIST

ITEM	PART NO.	DESCRIPTION	QTY
1	9.802-166.0	Coupler, 3/8" Female	1
	9.802-100.0	Quick Coupler O-Ring	1
2	8.739-125.0	Hose, 3/8" x 50', 1 Wire, Tuff-Flex	1
3	9.802-223.0	Spray Gun, Shut-Off	1
4	9.802-220.0	Wand, Straight	1
5	9.802-164.0	Coupler, 1/4" Female	1
	9.802-096.0	Quick Coupler O-Ring	1
6	Nozzle, See Page 13 For Size		
7	8.712-398.0	Nozzle, Brass Soap	1
8	9.802-216.0	Injector, Chemical, Non-Adjust, 3-5GPM, .083	1
9	6.390-126.0	Clamp, Hose, .46 - .54 ST	2
10	9.802-251.0	Tube, 1/2" x 1/2" Clear Vinyl	6 ft.
11	8.707-057.0	Strainer, 1/4" Hose Barb, Plastic	1

▲ Not Shown

UU1 UNLOADER EXPLODED VIEW

9.175-018.0

UU1 3500PSI, UNIVERSAL UNLOADER (SPARE)

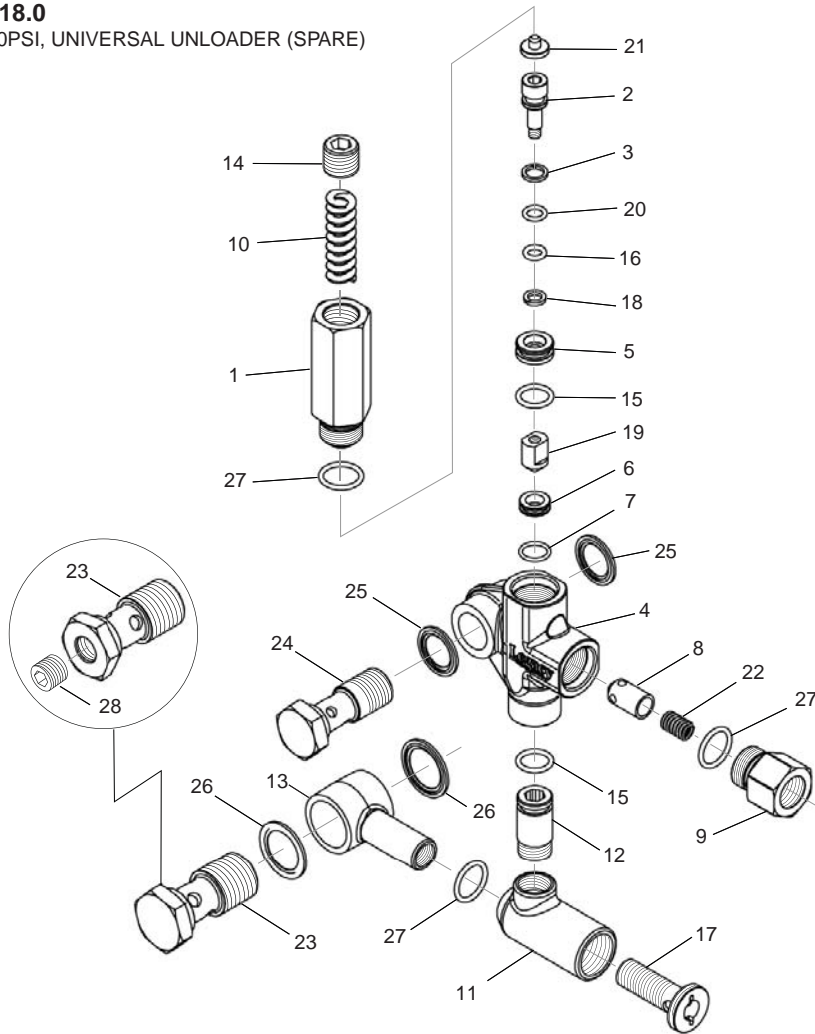

UU1 UNLOADER EXPLODED VIEW PARTS LIST

ITEM	PART #	DESCRIPTION	KIT	QTY	ITEM	PART #	DESCRIPTION	KIT	QTY
1	8.749-792.0	Piston housing		1	17	9.149-006.0	Sliding connector guide		1
2		Piston	C	1	18		O-ring backup 6X 1.45X 1.68	A	1
3		Piston O-ring back up	A	1	19		Conical seal	C	1
4	8.749-796.0	Main block		1	20		O-ring 6.75 X 1.78 BN80	A	1
5	9.152-372.0	Piston ring		1	21		Spring seat	C	1
6		Ball seat	C	1	22		Plunger spring	B	1
7		O-ring 10.5 ID X 1.5 CS	A,C	1	23	8.917-699.0	Banjo bolt 1/2" short		1
8		Plunger	B	1		8.917-700.0	Banjo bolt 1/2"-1/4"NPT short		1
9	9.152-016.0	Plunger housing		1		8.917-698.0	Banjo bolt 3/8" short		1
10		Bypass spring	C	1	24	8.917-698.0	Banjo bolt 3/8" short		1
11	9.149-001.0	Low pressure port		1	25	9.802-893.0	Seal washer 3/8"		2
12	9.152-017.0	Sliding connector, 30mm		1	26	9.803-921.0	Seal washer 1/2"		2
	8.762-005.0	Sliding connector, 40mm, long		1		9.802-893.0	Seal washer 3/8"		2
13	9.149-002.0	Sliding connector H 1/2"		1	27		O-RING 15 ID x 2CS	A,B	3
	9.149-005.0	Sliding connector H 3/8"		1	28	8.706-865.0	Plug, 1/4" countersunk		1
14	9.196-011.0	Plug 5/8 -18 UNF		1	Kit A	9.104-038.0	O-ring Repair Kit		
15		O-ring 12 ID x 2 CS	A	2	Kit B	9.104-039.0	Outlet Kit		
16		O-ring 6 ID X 2 CS	A	1	Kit C	9.104-040.0	Stem Repair Kit		

KE.1 SERIES PUMP EXPLODED VIEW

9.803-814.0 KE 2020F
 9.803-815.0 KE 2020S
 9.803-816.0 KE 2825F
 9.803-817.0 KE 2825S
 9.803-818.0 KE 3525F

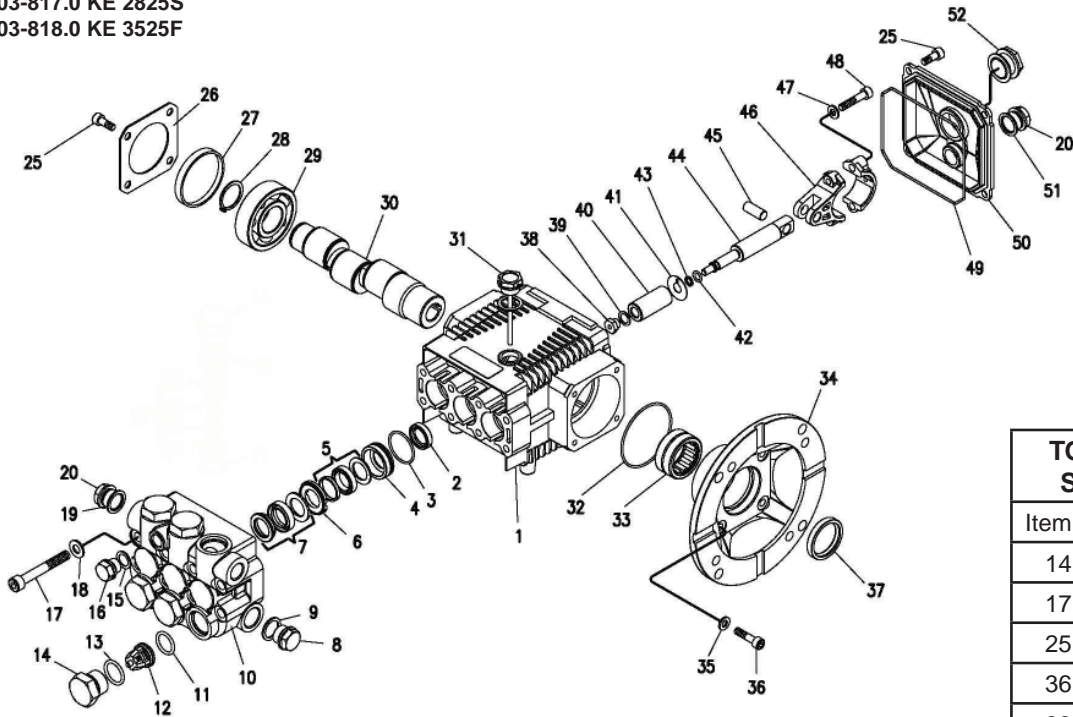

TORQUE SPECS	
Item #	Ft.-lbs
14	65
17	18
25	7.6
36	8
38	7
48	13

KE.1 SERIES PUMP EXPLODED VIEW PARTS LIST

ITEM	PART NO.	DESCRIPTION	QTY	ITEM	PART NO.	DESCRIPTION	QTY
1	9.803-938.0	Crankcase	1	16	9.803-951.0	Brass Plug G1/4	1
2*	9.804-586.0	Plunger Oil Seal	3	17	9.803-952.0	Manifold Stud Bolt	8
3*	See Kit Below	O-Ring Ø 1.78 x 28.30	3	18	9.802-884.0	Washer	8
4*	See Kit Below	Pressure Ring 15mm	3	19	9.803-198.0	Copper Washer 3/8	1
	See Kit Below	Pressure Ring 18mm	3	20	9.802-925.0	Brass Plug G3/8	2
5*	See Kit Below	U-Seal, dia 15mm	6	25	9.802-939.0	Screw	12
	See Kit Below	U-Seal, dia 18mm	6	26	9.803-953.0	Bearing Cover	2
6*	See Kit Below	Intermediate Ring 15mm	6	27	9.803-954.0	Bearing Seal	1
	See Kit Below	Intermediate Ring 18mm	6	28	9.802-914.0	Snap Ring	1
7*	See Kit Below	U-Seal, 15mm	3	29	9.803-955.0	Ball Bearing	2
	See Kit Below	U-Seal, 18mm	3	30	9.804-576.0	Crankshaft (2020F)	1
8	9.802-926.0	Brass Plug G1/2	1		9.804-577.0	Crankshaft (2020S)	1
9	9.803-199.0	Copper Washer 1/2"	1		9.804-578.0	Crankshaft (2825F)	1
10	9.803-946.0	Manifold Housing	1		9.804-579.0	Crankshaft (2825S)	1
11	9.803-947.0	O-Ring Ø1.78 x 15.54	6		9.804-580.0	Crankshaft (3525F)	1
12*	See Kit Below	Valve Assembly	6	31	9.803-957.0	Oil Dipstick	1
13*	9.803-948.0	O-Ring Ø2.62 x 18.77	6	32	9.804-581.0	O-Ring Ø3.53 x 55.56	1
14	9.803-949.0	Valve Plug	6	33	9.804-582.0	Needle Bearing	1
15	9.803-950.0	Copper Washer 1/4	1	34	9.804-583.0	Motor Flange 56C	1
				35	9.803-210.0	Washer	4

KE.1 SERIES PUMP EXPLODED VIEW PARTS LIST

ITEM	PART NO.	DESCRIPTION	QTY
36	9.804-584.0	Flange Screw	4
37	9.804-585.0	Crankshaft Seal	1
38*	See Kit Below	Plunger Nut	3
39*	See Kit Below	Copper Spacer	3
40*	See Kit Below	Plunger 15mm (2020F, 2825F, 3525F) 3	
	See Kit Below	Plunger 18mm (2020S, 2825S)	3
41*	See Kit Below	Copper Spacer	3
42*	See Kit Below	O-Ring Ø1.78 x 5.28	3
43*	See Kit Below	Teflon Ring	3
44	9.803-964.0	Plunger Rod	3
45	9.803-965.0	Connecting Rod Pin	3
46	9.803-966.0	Connecting Rod	3
47	9.803-218.0	Spring Washer	6
48	8.933-020.0	Connecting Rod Screw	6
49	9.803-969.0	O-Ring Ø2.62 x 107.62	1
50	9.803-968.0	Crankcase Cover	1
51	9.803-197.0	Gasket	1
52	9.803-202.0	Sight Glass	1

REPAIR KIT NUMBER	8.725-354.0	8.725-350.0	8.725-355.0	8.725-357.0	9.803-934.0	9.803-935.0	9.803-936.0	9.803-937.0
KIT DESCRIPTION	Plunger Seal 15mm 2020F.1 2825F.1 3525F.1	Plunger Seal 18mm 2020S.1 2825S.1	Complete Seal Packing 15mm 2020F.1 2825F.1 3525F.1	Complete Seal Packing 18 mm 2020S.1 2825S.1	Plunger 15mm 2020F.1 2825F.1 3525F.1	Plunger 18mm 2020S.1 2825S.1	Complete Valve	Plunger Oil Seals
ITEM NUMBERS INCLUDED	3, 5, 7	3, 5, 7	3, 4, 5, 6, 7	3, 4, 5, 6, 7	38, 39, 40, 41, 42, 43	38, 39, 40, 41, 42, 43	11, 12, 13	2
NO. OF CYLINDERS KIT WILL SERVICE	3	3	1	1	1	1	6	3

SPECIFICATIONS

HD Models

Machine		Pressure	Nozzle		Pump	Pump	Unloader	Motor	Motor
Model	GPM	(PSI)	Size	Hose p/n	Part #	Model	Part #	Hp	Part #
1.575-250.0	2.0	1000	3.75	9.802-233.0	9.803-814.0	KE2020F	9.175-018.0	1-1/2	9.802-338.0
1.575-251.0	1.9	1500	3.0	9.802-233.0	9.803-814.0	KE2020F	9.175-018.0	2	9.802-339.0
1.575-252.0	2.8	1000	5.5	9.802-233.0	9.803-816.0	KE-2825-F	9.175-018.0	2	9.802-339.0
1.575-253.0	3.5	2000	5.0	9.802-233.0	9.803-818.0	KE-3525-F	9.175-018.0	5	9.802-341.0

DE Models

Machine		Pressure	Nozzle		Pump	Pump	Unloader	Motor	Motor
Model	GPM	(PSI)	Size	Hose p/n	Part #	Model	Part #	Hp	Part #
1.106-061.0	2.0	1000	3.75	9.802-233.0	9.803-814.0	KE2020F	9.175-018.0	1-1/2	9.802-338.0
1.106-062.0	1.9	1500	3.0	9.802-233.0	9.803-814.0	KE2020F	9.175-018.0	2	9.802-339.0
1.106-063.0	2.8	1000	5.5	9.802-233.0	9.803-816.0	KE-2825-F	9.175-018.0	2	9.802-339.0
1.106-064.0	3.5	2000	5.0	9.802-233.0	9.803-818.0	KE-3525-F	9.175-018.0	5	9.802-341.0

**LIMITED NEW PRODUCT
WARRANTY—COMMERCIAL
PRESSURE WASHERS**



Phone: 800-771-1881
Fax: 877-526-3246
www.shark-pw.com

WHAT THIS WARRANTY COVERS

All Shark pressure washers are warranted by Shark to the original purchaser to be free from defects in materials and workmanship under normal use, for the periods specified below. This Limited Warranty, subject to the exclusions shown below, is calculated from the date of the original purchase, and applies to the original components only. Any parts replaced under this warranty will assume the remainder of the pressure washer's warranty period.

FIVE YEAR PARTS AND ONE YEAR LABOR WARRANTY

Components manufactured by Shark, such as frames, handles, float tanks, fuel tanks, belt guards, and heating coils. Pro-Duty rated units (DD Series) have a three-year limited warranty against defects and workmanship. Internal components on the oil-end of Kärcher axial pumps have a 5 year warranty. Kärcher crankshaft pumps have a 7 year warranty on non-wear parts. Heating coils are pro-rated at 25% after 2 years. Kärcher and non-Kärcher swash and wobble plate pumps have a one year warranty; other pumps carry their manufacturer's warranty.

ONE YEAR PARTS AND ONE YEAR LABOR WARRANTY

All other components, excluding normal wear items as described below, will be warranted for one year on parts and labor. Parts and labor warranty on these parts will be for one year regardless of the duration of the original component manufacturer's part warranty.

WARRANTY PROVIDED BY OTHER MANUFACTURERS

Motors, generators, and engines, which are warranted by their respective manufacturers, are serviced through these manufacturers' local authorized service centers. Shark is not authorized and has no responsibility to provide warranty service for such components. Motors manufactured outside of the United States will be warranted by Shark.

WHAT THIS WARRANTY DOES NOT COVER

This warranty does not cover the following items:

1. Normal wear items, such as nozzles, spray guns, discharge hoses, wands, quick couplers, seals, filters, gaskets, O-rings, packings, pistons, pump valve assemblies, strainers, belts, brushes, rupture disks, fuses, pump protectors.
2. Any components or other devices incorporated into a Shark product that are not manufactured by Shark, including, but not limited to gasoline engines, pumps, etc.
3. Defects caused by improper or negligent operation or installation, accident, abuse, misuse, neglect, unauthorized modifications, repair or maintenance of the product by persons other than authorized representatives of Shark, including, but not limited to, the failure of the Customer to comply with recommended product maintenance schedules.
4. Shark products that have been returned by the original Customer and are ultimately re-sold by an Authorized Servicing Dealer or other sales or service outlet to another purchaser.
5. Shark products that are sold by any distributor or retailer that is not an official authorized dealer or retailer of Shark products.
6. Defects caused by acts of nature and disaster including, but not limited to, floods, fires, wind, freezing, earthquakes, tornadoes, hurricanes and lightning strikes.
7. Defects caused by water sediments, rust corrosion, thermal expansion, scale deposits or a contaminated water supply (such as water in the unit with chloride content higher than that of 80 mg/liter or use of chemicals not approved or recommended by Shark).
8. Defects caused by improper voltage, voltage spikes or power transients in the electrical supply.
9. Devices or accessories not distributed or approved by Shark.
10. Any cost of labor arising from the removal and reinstallation of the alleged defective part by Customer.
11. Transportation of the product to an Authorized Servicing Dealer, field labor, replacement rental and any freight charges.

Any components, accessories or other devices provided with the product but not manufactured by Shark (such as engines, pumps, etc.) are subject to warranties and service through their respective manufacturers authorized service centers and according to the applicable terms and conditions of such manufacturers warranties. Such components or other devices not manufactured by Shark should be referred by the Customer to an authorized service center or their respective manufacturers for repair or replacement.

THE FOREGOING WARRANTY IS IN LIEU OF ALL OTHER WARRANTIES OF ANY KIND, WHETHER ARISING BY LAW, CUSTOM OR CONDUCT. SHARK MAKES NO ADDITIONAL WARRANTIES, EITHER EXPRESSED OR IMPLIED, INCLUDING, WITHOUT LIMITATION, ANY EXPRESSED OR IMPLIED WARRANTIES OF MERCHANTABILITY OR FITNESS OF EQUIPMENT FOR A PARTICULAR PURPOSE AND ANY SUCH WARRANTIES ARE EXPRESSLY DISCLAIMED. SHARK FURTHER DISCLAIMS ANY WARRANTY THAT THE PRODUCT PURCHASED BY CUSTOMER WILL MEET ANY PARTICULAR REQUIREMENT OF CUSTOMER EVEN IF SHARK HAS BEEN ADVISED OF SUCH REQUIREMENT.

THE RIGHTS AND REMEDIES PROVIDED UNDER THIS WARRANTY ARE EXCLUSIVE AND IN LIEU OF ANY OTHER RIGHTS OR REMEDIES OF CUSTOMER. SHARK SHALL NOT UNDER ANY CIRCUMSTANCES BE LIABLE TO ANY PERSON OR ENTITY INCLUDING, BUT NOT LIMITED TO, THE CUSTOMER OR ANY END USER OF THE PRODUCT FOR ANY SPECIAL, INDIRECT, INCIDENTAL OR CONSEQUENTIAL DAMAGES OR ECONOMIC LOSS, LOSS OF PROFITS OR LOSS OF USE OF THE PRODUCT, ARISING IN CONNECTION WITH THE SALE, DELIVERY, INSTALLATION, TRAINING OR USE OF PRODUCT. SHARK'S LIABILITY, WHETHER IN CONTRACT OR IN TORT, ARISING OUT OF ANY WARRANTIES OR REPRESENTATIONS, INSTRUCTIONS OR DEFECTS FROM ANY CAUSE, SHALL BE LIMITED EXCLUSIVELY TO THE COST OF REPAIR OR REPLACEMENT PARTS UNDER AFORESAID CONDITIONS.

The purpose of the foregoing limitations on liability and Customer remedies is to protect Shark from unknown or undeterminable risks. Some states do not allow the exclusion or limitation of incidental or consequential damages, so the above limitation or exclusion may not apply to the Customer.

Shark sales and service representatives are not authorized to waive or alter the terms of this warranty, or to increase the obligations of Shark under the warranty.

Shark reserves the right to make design changes in any of its products without prior notification to the Customer.



www.shark-pw.com

Form # 8.919-015.0 • Revised 01/11 • Printed in U.S.A. or México