

**DA-LITE IS MORE
THAN PROJECTION SCREENS**

Da-Lite Tripod, Wall and
Ceiling and Electric Screens

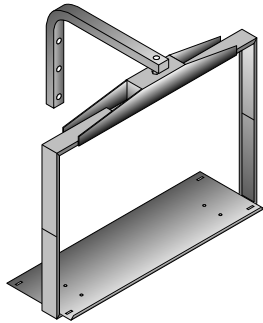

Da-Lite
Monitor Mounts

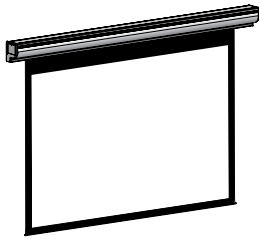
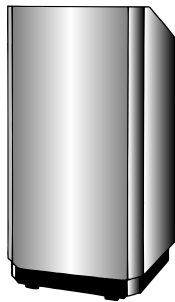

Da-Lite Lecterns



Da-Lite
Project-O-Stands
and Easels

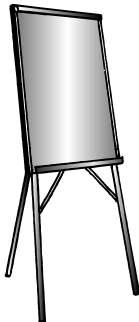

*Installation Operating
Instructions For
Tilt-Lock™*

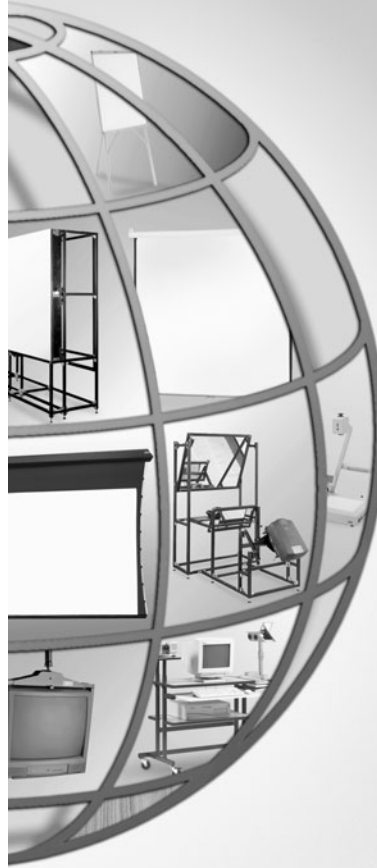

The
POWER *In*
PRESENTATION PRODUCTS

DA-LITE

DA-LITE SCREEN COMPANY, INC.

3100 North Detroit Street
Post Office Box 137
Warsaw, Indiana 46581-0137
Phone: 574/267-8101
800-622-3737
Fax: 574/267-7804
[http:// www.da-lite.com](http://www.da-lite.com)
e-mail: info@da-lite.com

FOR KEYSTONE ELIMINATION

TILT LOCK

For Keystone Elimination

Magnet holds back bottom of screen in tilted position to eliminate keystoneing.

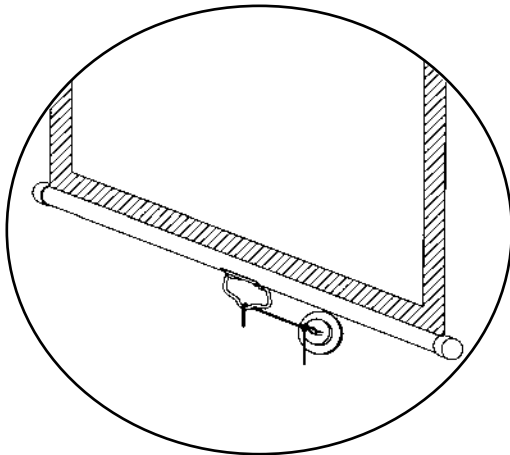

1. Lock projection screen in down position.
2. Secure screen pull cord to hook with knot at approximate desired location.
3. Pull projection screen back by cord and place flat of magnet against wall in such a way that pull cord and hook are perpendicular to wall. Mark this position on wall. See diagram.

Remove protective paper from adhesive surface of wall plate. Place on marked position on wall and press firmly. Be sure wall plate is pressed securely onto wall.

If necessary, readjust hook on cord by adjusting the knot for desired angle of screen surface. Then tighten knot on hook. Close hook with pliers. See diagram.

4. To release projection screen for closure, pull hook from wall plate with slight twisting motion.

PROTECT YOUR SCREEN by keeping it rolled in its protective case when not in use. Always examine both front and back of surface before re-rolling into case to make certain screen is free of dust, dirt or other foreign matter. Use a very soft duster brush gently to remove foreign particles.

Care in mounting and care in correct operation will mean a long and satisfactory life for wall type screens.

WALL BRACKETS

WALL BRACKETS

Da-Lite No. 6 and No. 11 Non-adjustable wall brackets and No. 23 adjustable extension wall brackets are ideal for keystone elimination, chalkboard clearance, or corner mounting. The screen brackets should be fastened to the studding or other solid surface and not in the plaster only. Suspend screen from "D" rings.

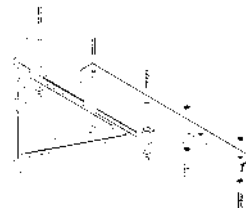

No. 23 ADJUSTABLE WALL BRACKETS

Screen can be extended 18½", 20" or 24" from wall by wing nut and bolt adjustment.

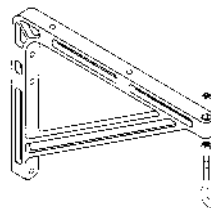

No. 11 WALL BRACKETS

Screen can be extended 10" or 14" from wall by changing position of bracket.

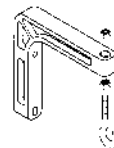

No. 6 WALL BRACKETS

Screen can be extended 6" from wall.