



MODEL B[®] with CSR

CONTROLLED SCREEN RETURN

Spring Roller-Type Screen

DA-LITE SCREEN COMPANY, INC.
 3100 North Detroit Street
 Post Office Box 137
 Warsaw, Indiana 46581-0137
 Phone: 574-267-8101
 800-622-3737
 Fax: 574-267-7804
 Toll Free Fax: 877-325-4832
 www.da-lite.com
 e-mail: info@da-lite.com

SPECIFICATION DATA

SUGGESTED SPECIFICATIONS: _____ projection screen(s), _____ (H) x _____ (W), wall or ceiling mounting type. Screen to have a powder coated white 22-gauge octagonal steel case with flat back design and fitted with end caps concealing roller ends with integral bearing surface to support roller and integral brackets for wall mounting by means of slotted screw holes and ceiling mounting by means of powder coated hanger rings. To be equipped with Controlled Screen Return (CSR) to control the return speed of the screen into the case. Bottom of fabric shall be mounted securely into a powder coated tubular steel slat. Ends of slat shall be protected by plastic caps. A steel pull bail shall be attached to slat. A 36" (91 cm) pull cord with plastic knob is included. To have masking borders standard on flame retardant and mildew resistant fiberglass fabric. Fabric shall be mounted into a metal strip in a metal Camlok[®] roller system without tape, glue, staples or cords so that fabric may be easily replaced yet cannot be pulled from roller.

Matte White, Video Spectra 1.5 and High Contrast Matte White: Surfaces will be seamless.

High Power[®]: Horizontal seam required when both dimensions exceed 6' (183 cm).

VIDEO (NTSC 4:3) FORMAT DIMENSIONS

Viewing Area		Nominal Diagonal		A - Overall Length of Case		B - Between Hanger Eyes		C - Brackets		D - Case Diameter (Width)		Approx. Ship. Wt.	
H x W	Cm	In.	Cm	In.	Cm	In.	Cm	In.	Cm	In.	Cm	Lbs.	Kg
43" x 57"	109 x 145	72"	183	63 ³ / ₈ "	161	62 ⁵ / ₈ "	159	3 ⁵ / ₈ "	9.2	2 ³ / ₄ "	7	16	7.3
50" x 67"	127 x 170	84"	213	73 ³ / ₈ "	186	72 ⁵ / ₈ "	184	3 ⁵ / ₈ "	9.2	2 ³ / ₄ "	7	17	7.7
57" x 77"	145 x 196	96"	244	84 ³ / ₈ "	214	83 ⁵ / ₈ "	212	3 ⁵ / ₈ "	9.2	2 ³ / ₄ "	7	25	11.3
60" x 80"	152 x 203	100"	254	87 ³ / ₈ "	222	86 ⁵ / ₈ "	220	3 ⁵ / ₈ "	9.2	2 ³ / ₄ "	7	26	11.8
69" x 92"	175 x 234	120"	305	99 ³ / ₈ "	252	98 ⁵ / ₈ "	251	3 ⁵ / ₈ "	9.2	2 ³ / ₄ "	7	29	13.2

HDTV (16:9) FORMAT DIMENSIONS

Viewing Area		Nominal Diagonal		A - Overall Length of Case		B - Between Hanger Eyes		C - Brackets		D - Case Diameter (Width)		Approx. Ship. Wt.	
H x W	Cm	In.	Cm	In.	Cm	In.	Cm	In.	Cm	In.	Cm	Lbs.	Kg
37 ¹ / ₂ " x 67"	95 x 170	77"	196	73 ³ / ₈ "	186	72 ⁵ / ₈ "	184	3 ⁵ / ₈ "	9.2	2 ³ / ₄ "	7	16	7.3
45" x 80"	114 x 203	92"	234	87 ³ / ₈ "	222	86 ⁵ / ₈ "	220	3 ⁵ / ₈ "	9.2	2 ³ / ₄ "	7	25	11.3
52" x 92"	132 x 234	106"	269	99 ³ / ₈ "	252	98 ⁵ / ₈ "	251	3 ⁵ / ₈ "	9.2	2 ³ / ₄ "	7	28	12.7

16:10 WIDE FORMAT DIMENSIONS

Viewing Area		Nominal Diagonal		A - Overall Length of Case		B - Between Hanger Eyes		C - Brackets		D - Case Diameter (Width)		Approx. Ship. Wt.	
H x W	Cm	In.	Cm	In.	Cm	In.	Cm	In.	Cm	In.	Cm	Lbs.	Kg
50" x 80"	127 x 203	94"	239	87 ³ / ₈ "	222	86 ⁵ / ₈ "	220	3 ⁵ / ₈ "	9.2	2 ³ / ₄ "	7	24	10.9
57 ¹ / ₂ " x 92"	146 x 234	109"	277	99 ³ / ₈ "	252	98 ⁵ / ₈ "	251	3 ⁵ / ₈ "	9.2	2 ³ / ₄ "	7	26	12.3

SQUARE FORMAT DIMENSIONS

Sizes		A - Overall Length of Case		B - Between Hanger Eyes		C - Brackets		D - Case Diameter (Width)		Approx. Ship. Wt.	
H x W	Cm	In.	Cm	In.	Cm	In.	Cm	In.	Cm	Lbs.	Kg
60" x 60"	152 x 152	63 ³ / ₈ "	161	62 ⁵ / ₈ "	159	3 ⁵ / ₈ "	9.2	2 ³ / ₄ "	7	16	7.3
70" x 70"	178 x 178	73 ³ / ₈ "	186	72 ⁵ / ₈ "	184	3 ⁵ / ₈ "	9.2	2 ³ / ₄ "	7	19	8.6
72" x 72"	183 x 183	75 ⁵ / ₈ "	191	74 ⁵ / ₈ "	190	3 ⁵ / ₈ "	9.2	2 ³ / ₄ "	7	21	9.5
84" x 84"	213 x 213	87 ³ / ₈ "	222	86 ⁵ / ₈ "	220	3 ⁵ / ₈ "	9.2	2 ³ / ₄ "	7	28	12.7
96" x 96"	244 x 244	99 ³ / ₈ "	252	98 ⁵ / ₈ "	251	3 ⁵ / ₈ "	9.2	2 ³ / ₄ "	7	32	14.5

Overall case length dimensions ±1/4" (6 mm).
 Specifications subject to change without notice.
 Hanger rings add 3/4" (19 mm) to the overall dimension C.
 Custom formats and sizes available upon request.

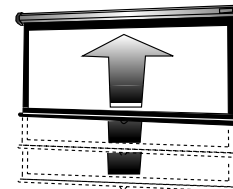

WHEN ORDERING, MARK APPROPRIATE SELECTIONS:

Select size from charts above.

Select viewing surface:

- Matte White
- High Contrast Matte White
- Video Spectra 1.5
- High Power
- GREENGUARD[®] and GREENGUARD[®] Children and Schools Certified.

Optional Accessories:

(Select):

- No. 6 Wall Bracket – 6" (15 cm) non-adjustable extension brackets (75#, 34 kg, per pair maximum) (black or white).
- No. 11 Wall Bracket – 10" or 14" (25 or 36 cm) non-adjustable extension brackets (75#, 34 kg, per pair maximum) (black or white).
- No. 23 Adjustable Wall Bracket – 10", 14", 15³/₄", 18¹/₄", 20", or 24" (25, 36, 40, 46, 51 or 61 cm) adjustable extension brackets (75#, 34 kg, per pair maximum) (black or white).
- Tilt-Lock for Keystone Elimination (used with extension brackets).
- T-Bar Clip for drop ceilings (50#, 23.7 kg, per pair maximum) (black or white).
- Pull Rod - 38" (97 cm).
- No borders (Black masking borders standard).
- Black case (white standard).

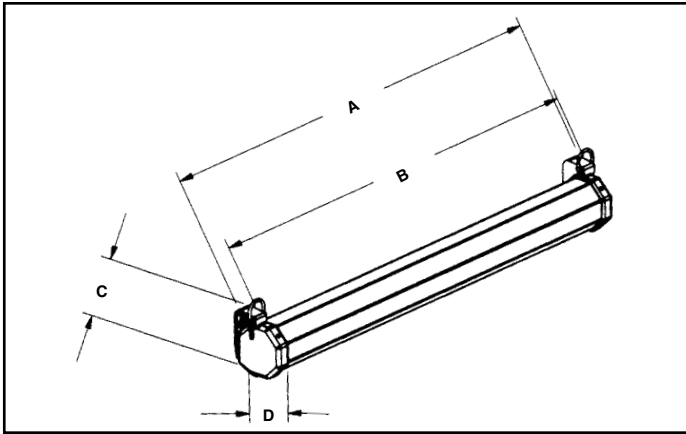

Project: _____

Architect: _____

Phone: _____

Contractor: _____

Phone: _____

Supervisor: _____

Phone: _____

Date: _____

Revised: _____

MODEL B® WITH CSR

OPTIONAL ACCESSORIES

OPTIONAL ACCESSORIES: to provide clearance: Furnish 6" (15 cm) heavy extension wall brackets to mount screen. To provide for keystone elimination: Furnish #11 or #23 adjustable extension wall brackets. Furnish magnetic tilt lock for keystone elimination.

NOTE: Brackets also are used for mounting screen across a corner.

EXTENSION WALL BRACKETS (75#, 34 KG, PER PAIR MAXIMUM)

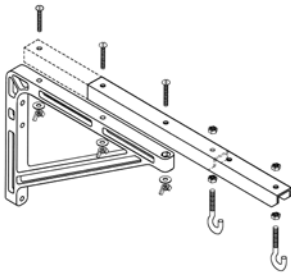

No. 23 ADJUSTABLE WALL BRACKET

Screen can be extended 10", 14", 15¾", 18¼", 20" or 24" from wall by wing nut and bolt adjustment.
(25, 36, 40, 46, 51 or 61 cm)

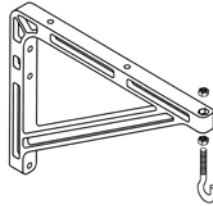

No. 11 WALL BRACKET

Non-adjustable. Permits screen to extend 10" or 14" from wall.
(25 or 36 cm)



No. 6 WALL BRACKET

Non-adjustable. Permits screen to extend 6" from wall.
(15 cm)

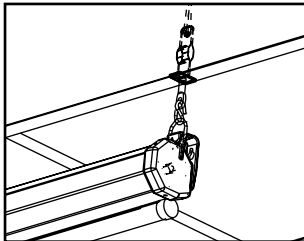

T-BAR CLIP (50#, 23.7 KG, PER PAIR MAXIMUM)

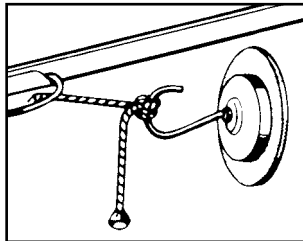

TILT LOCK for Keystone elimination. Used with extension brackets or T-Bar Clips.

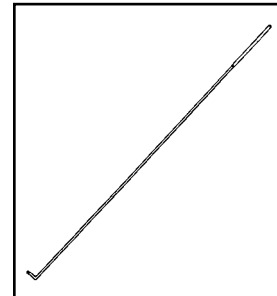

PULL ROD - 38" (97 CM)

Zinc plated rod with black plastic handle grip allows easy access to screen when mounted out of reach. Also can be used as a pointer.