

1

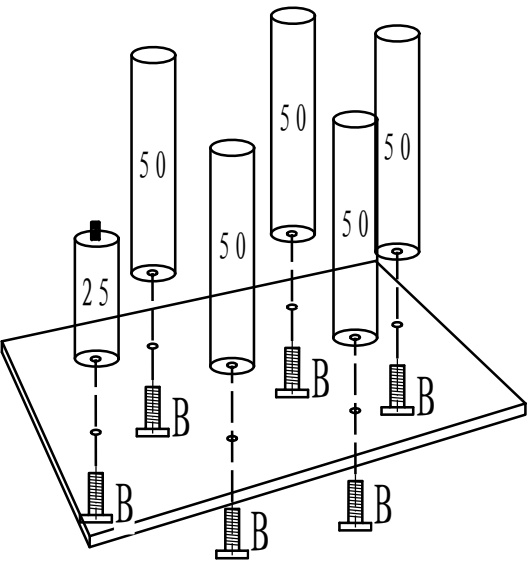

2

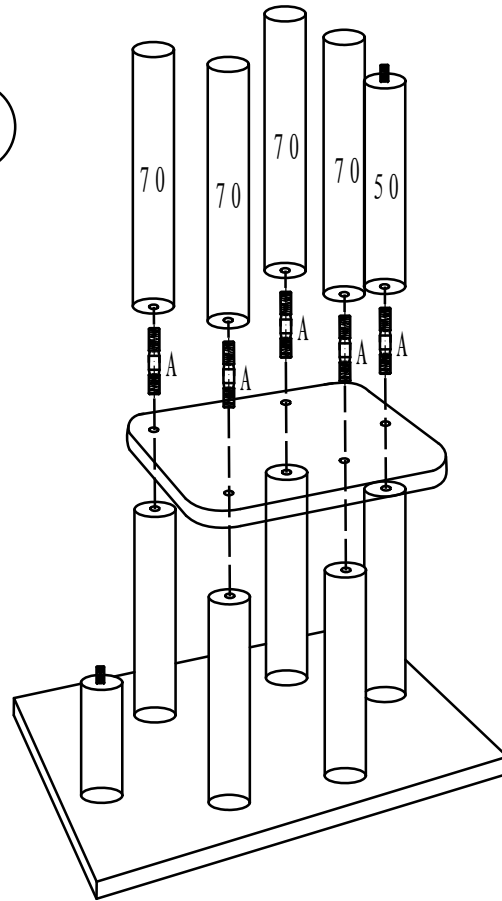



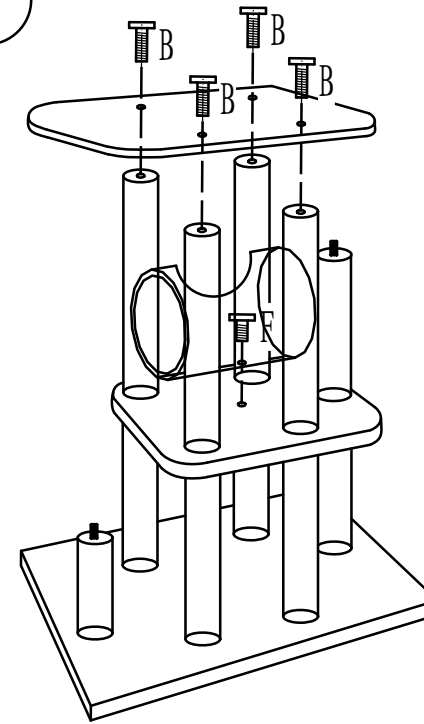

3

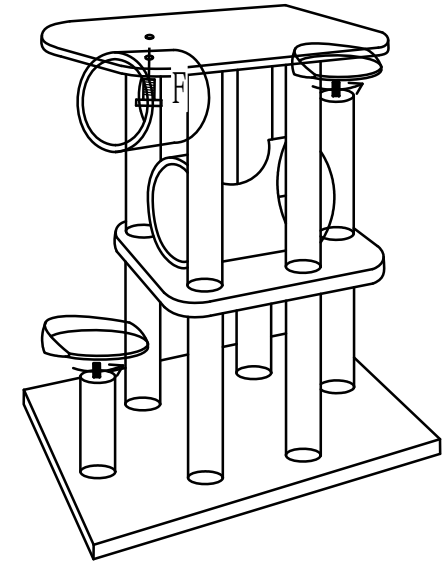

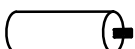

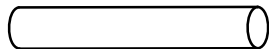

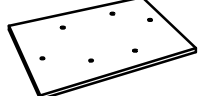

4



- 1 ×   $\varnothing 7 \times 25\text{cm}$
- 5 ×   $\varnothing 7 \times 50\text{cm}$
- 1 ×   $\varnothing 7 \times 50\text{cm}$
- 4 ×   $\varnothing 7 \times 70\text{cm}$

- 1 ×  70 × 48.5cm
- 1 ×  48.5 × 45cm
- 1 ×  48.5 × 45cm

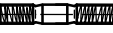
- 1 ×   $\varnothing 25 \times 30\text{cm}$
- 1 ×   $\varnothing 20 \times 16.7\text{cm}$
- 1 ×   $\varnothing 30\text{cm}$

- 1 ×  8.0 × 60mm
- (5+1) ×  8.0 × 70mm A
- (10+1) ×  8.0 × 40mm B
- 2 ×  8.0 × 25mm E