



gigatent

THE NEXT LEVEL IN CAMPING

WWW.GIGATENT.COM

FT020

Katahdin

13' x 9' x 84" (H)

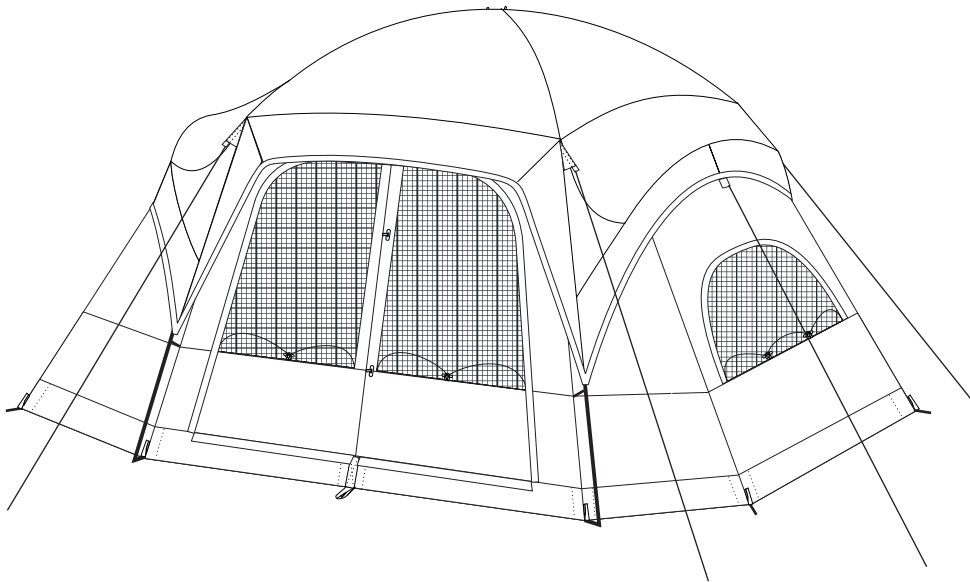

OWNER'S MANUAL

IMPORTANT

We strongly suggest setting up your new tent before going camping to insure that all parts are present and to familiarize yourself with the tents assembly. This will have a great effect on how well you enjoy your camping trip.

Manufactured in our state of the art factory in China

Assembly instructions

Frame Parts

Pole Hubs

Corner  X 4

(Attached to tent)

Fiberglass Poles

Main Pole (X 2)

Side Pole (X 2)

Eave Pole (X 4)

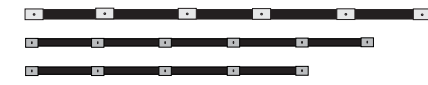

Steel Poles

Leg Pole (X 4)



Step 1- TENT SET UP

(To prolong the life of your floor we suggest the use of a ground cloth cut slightly smaller than the floor of your tent and that you select a campsite that is level and free of rocks and roots.)

- 1) Spread the tent body out on the ground.
- 2) Fully open all of the poles.
- 3) Carefully thread the main poles through the pole sleeves that cross over the top of the roof (Figure A).
- 4) Carefully thread the eave poles through the perimeter pole sleeves (Figure B).
- 5) Insert the both ends of the main poles into the corner hubs (Figure C).
- 6) Starting in one corner insert the eave poles into the corner hubs (Figure D) and work around the perimeter of the roof moving from one eave pole to the next.
- 7) Insert the end of one of the steel poles into one of the corner hubs **NOTE: the hubs attached to the steel poles should be located toward the top** (Figure E) and insert the pin located on a ring at the bottom of the tent into the end of the steel pole (Figure F) and repeat for the other steel poles.
- 8) Thread the side poles through the pole sleeves located below the eave poles on the sides (Figure G).
- 9) Insert the ends into the hubs attached to the steel leg poles (Figure H).
- 10) Attach the pole clips to the tent poles (Figure I).
- 11) Stake out the bottom of the tent using the metal rings and webbing loops (Figure J).

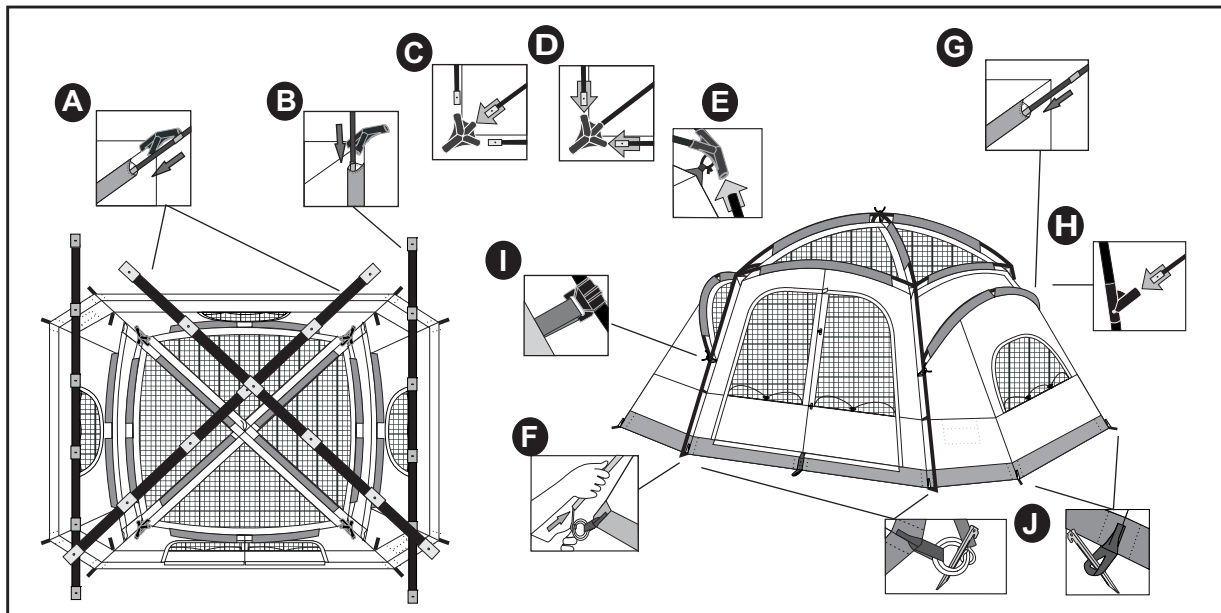

Step 2- ATTACHING the RAIN FLY

- 12) Open the rain fly and insure that it is right side up.
- 13) Drape the rain fly over the tent body (**this will be easier with 2 people**)
- 14) Attach the Velcro located on the underside of the fly around the poles (**Figure K**).
- 15) Attach the bungee cords to the ring at the bottom of each pole using the hook provided (**Figure L**).

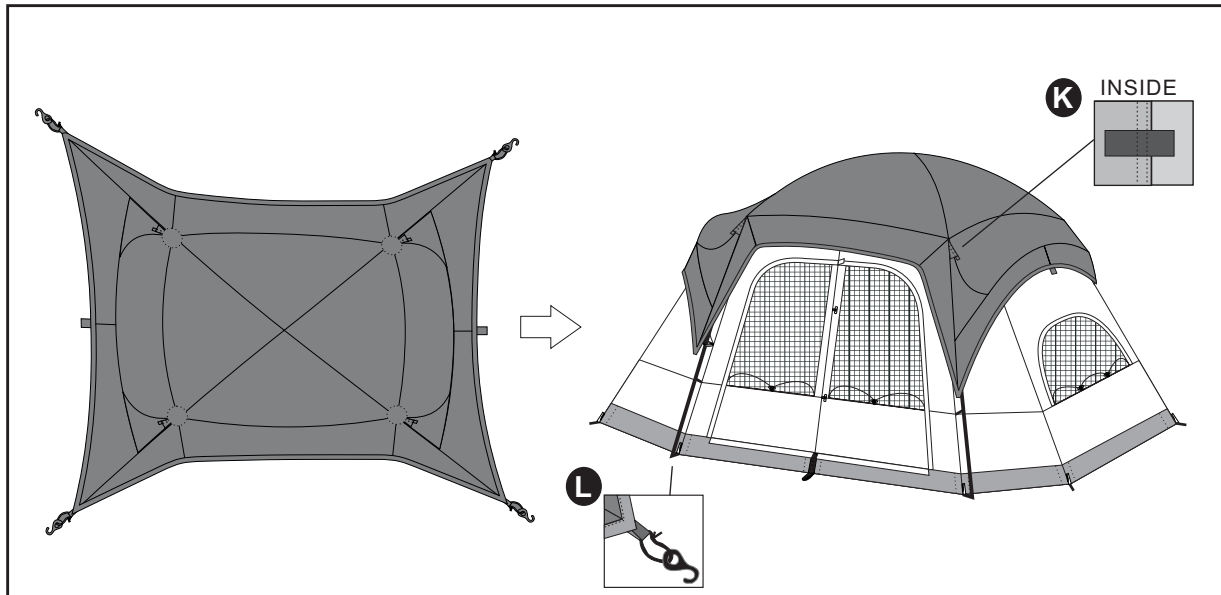

Step 3- EXTRA STABILITY in WINDY CONDITIONS

- 15) In windy conditions use the extra stakes and guylines to add extra stability (**FIGURE M**).

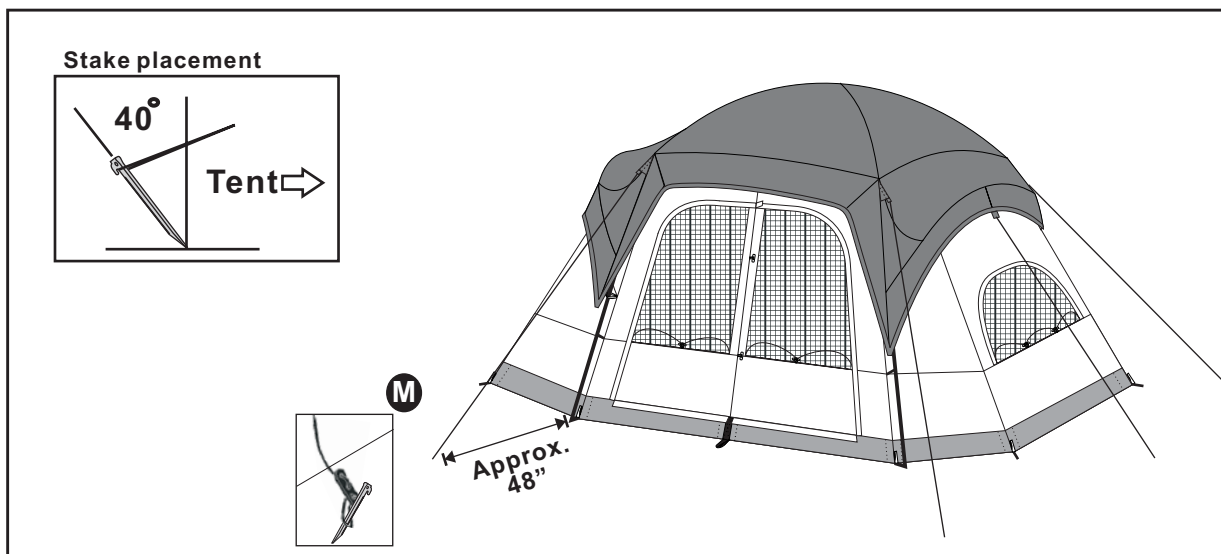

Replacement Parts

*Review your parts list above; to make sure all parts listed above have been included on your package.

Model FT 020

Frame Parts

Pole Hubs (Attached to tent) Qty

Corner	4
--------	---



Fiberglass Poles Qty

Main Pole	2
Side Pole	2
Eave Pole	4

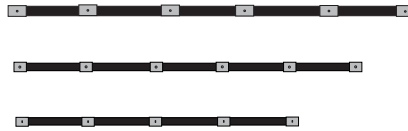

Steel Poles Qty

Leg Pole	4
----------	---



Misc. Parts Qty

Tent Body	1
Rain Fly	1
Tent Bag	1
Pole Bag	1
Stake Bag	1
Fly Bungee w/ hook	4
Pin & Ring	4
Guylines	6

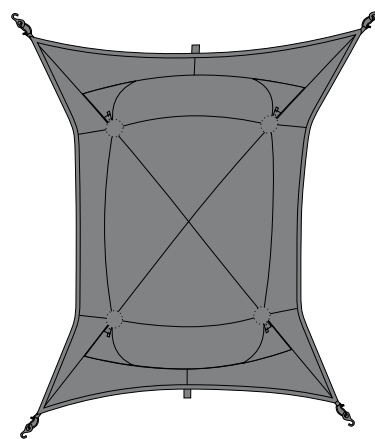

Rainfly

Tips and Tricks

In windy conditions wrap the fly bungee around the pole several times before hooking it to the ring, this will keep the rainfly from flapping.

Be sure to FULLY close the door zippers in rainy weather as water can find its way through an open zipper.

At a minimum we suggest SEAM SEALING the seams at the bottom of the windows to insure that water won't come through the needle holes.

In sandy soil a longer stake or a dead man will work better than a normal stake.

Carrying a combination of different types of stakes will make camping in different places easier and speed set up.

Be sure to leave the windows open as much as possible to minimize condensation buildup during rain.

Care

Ultra Violet (UV) Exposure

Your tent is made of UV resistant polyester fabric which is resistant but NOT impervious to the damaging effects of long term sun exposure. We DO NOT suggest long term set up of ANY of our products as this will severely damage the tent fabric.

Seam Sealing

Gigatent suggests that at a MINIMUM the seams at the bottom of the windows should be sealed using a product like McNetts Seam Sure to prevent moisture from coming through the needle holes. Follow the manufacturer's instructions when applying seam sealer.

Storage

DO NOT under any circumstances store your tent wet or damp. Mildew will quickly destroy a tent's waterproof coating. Allow your tent to dry and then store in a cool dry place.

Structural Integrity

Although the tent was constructed to rigid specifications periods of wind and soaking rain may loosen the stakes and guylines to the point of allowing the rainfly to flap. This can in turn cause the poles to loosen weakening the overall structure. Loosening of the rainfly can also create pockets that can collect water which can lead to pole failure. To insure that this does not occur take care during windy or rainy conditions that all of the stakes and guylines are secure and tight.

Washing Your Tent

NEVER machine wash a tent as this can cause damage to the waterproof coating. Hand wash with a mild soap and rinse with clean water and allow to COMPLETELY dry before storing. An extremely dirty tent can be set up and washed like a car or it can be washed in a bathtub using your hands to agitate the water or a soft brush.



Thank you for purchasing a quality product from GIGATENT.

This troubleshooting guide is designed to help you sort out some of the possible problems you might encounter with your new tent.

If you are still having problems with your purchase please contact us at 973-709-1111 or email us at info@gigatent.com

Troubleshooting Guide

PROBLEM	SOLUTION
Condensation	Condensation is caused by lower temperatures outside the tent which causes moisture vapor from humidity inside the tent and sleepers respiration to form water droplets on the walls and is mostly is visible in the corners. To prevent this from happening keep all objects away from the walls and open up windows to allow the moisture to escape
Mildew	To avoid mildew which can damage a tents waterproofing be sure to never store your tent damp or worse wet. If mildew occurs you can use a product such as McNett Mirazyme to clean your tent or you can use a simple 50/50 solution of Lemon Juice Concentrate and water to wash the area. After this you will want to wash the area with soap and water and then let it dry COMPLETELY before storing.
Tears or small holes	Tears and small holes can be fixed temporarily by using an adhesive patch kit found in most Camping Stores. For long term patches it is best to bring your tent to a repair facility or for minor repairs you can use Seam Grip sold by the McNett company. Simply follow the instructions on the package and this will provide a durable permanent patch.
Zipper Problems	Zippers have 2 parts, the slider which is the part that opens and closes the zipper, and the zipper teeth. What normally happens is the zipper separates behind the slider if this occurs carefully move the slider back past the separation and rezip. If this fails to fix the problem you may require a new zipper slider or a new complete zipper. Please call us and we can recommend a shop that will be able to fix it for you.
Seam Leakage	Seams can leak through the needle holes so applying a product such as McNett Seamsure to your tent before going camping is the best thing to do. We have seam sealed the rainfly for you but as a minimum we suggest sealing the seam along the base of all of the windows as this is the most likely place for leakage.



This product meets the flammability requirements of CPAI - 84. The fabric may burn if left in continuous contact with any flame source.

The application of any foreign substance to the product fabric, may render the flame resistant properties ineffective.

EXTREME CAUTION!

Never use any fuel burning oxygen consuming device, or any device that produce any fumes, including, stoves, lanterns, candles, hibachis, or heaters in or around your product. This could result in carbon monoxide poisoning, injury and/or death.

Warning

WARNING: KEEP ALL FLAME AND HEAT SOURCES AWAY FROM THIS TENT FABRIC.

This tent meets the flammability requirements of CPAI - 84. The fabric may burn if left in continuous contact with any flame source.

The application of any foreign substance to the product fabric may render the flame resistant properties ineffective.

DO NOT...

1. Do not pitch tent near an open flame.
2. Do not leave campfires unattended.
3. Do not allow CHILDREN or ADULTS to use lighted candles, matches or other flame sources in or near tents.
4. Do not use heating, lighting or cooking equipment with open flames in or near tents.
5. Do not use fuel burning/oxygen consuming

devices (i.e. heaters, lanterns, or other flame sources) inside your tent at any time.

6. Do not spray the tent with insecticide.

7. **EXTREME CAUTION:** Never use any fuel burning/oxygen consuming device, or any device that produces fumes (including stoves, lanterns, candles, hibachis, or heaters) in or around your tent. Inhalation of fumes may result in carbon monoxide poisoning, injury and/or death.

DO ...

1. Always extinguish campfire before leaving area.
2. Exercise care when using electricity and lighting in and near tents.
3. Disassemble and store tent properly after camping to ensure the tent's longevity.
4. Always use a hammer/mallet when driving stakes into the ground.

WARRANTY

Warranty Term :

5 years from the date of purchase

What is covered:

Warrants to the original purchaser that its products are free from defects in material and workmanship.

What Is Not Covered:

Shall not be responsible for the natural breakdown of materials that occurs inevitably with extended use(e.g., Ultraviolet(UV)light damage on tents,exhausted zippers), or defects caused by accident, abuse, alteration, animal attack, storm damage, misuse or improper care.

What Will Do:

If after inspection we find that a product failed due to a manufacturing or material defect,we will repair or replace the product, at our option, without charge.

How to Obtain Warranty Service :

Return the product, freight prepaid, to the GIGATENT Customer service department. For return authorization e-mail our office and obtain an Authorization number, Authorization numbers are valid for 30 days from the date of issuance, and must be obtained within 30 days of ship date. Returns will be handled in timely matter Collect shipments or shipments without return authorization will not be accepted.

Repairs:

If your Product needs service or repair due to normal wear and tear, animal attack, accident or some other reason that is not covered under the warranty we will provide the necessary service for a reasonable charge, plus shipping and handling. We require that products accepted for any repair most be properly cleaned according to our recommended care instructions. Please send your product or component that requires repair (e.g. tent fly), postage prepaid, along with a description of what needs attention.

REPLACEMENT PARTS:

Replacement parts may be ordered with consumer service at 1- 877 - TENTS 01 (873-8601)

We accept Visa Master Card and American express.

• WWW.GIGATENT.COM •