

Instructions

51-10000 – Chrome robe hook
51-15000 – Chrome paper holder
51-17000 – Chrome towel ring
51-18000 – Chrome 18" towel bar
51-24000 – Chrome 24" towel bar

51-10000-BN – Chrome robe hook
51-15000-BN – Chrome paper holder
51-17000-BN – Chrome towel ring
51-18000-BN – Chrome 18" towel bar
51-24000-BN – Chrome 24" towel bar

51-10000-BB – Chrome robe hook
51-15000-BB – Chrome paper holder
51-17000-BB – Chrome towel ring
51-18000-BB – Chrome 18" towel bar
51-24000-BB – Chrome 24" towel bar



Bath Accessories

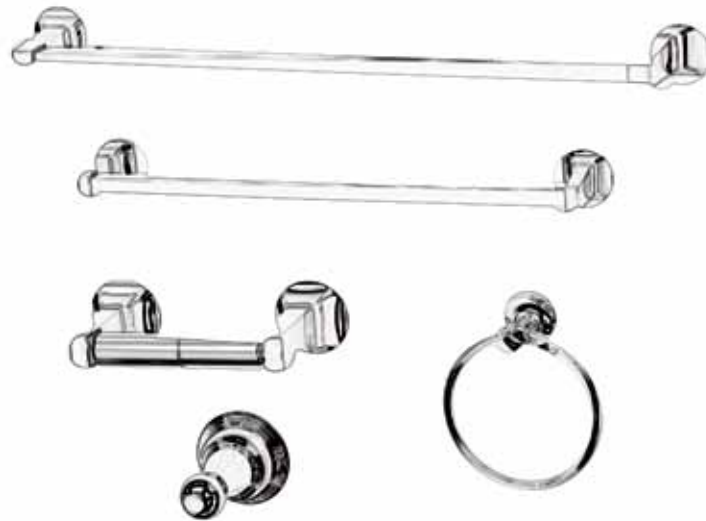

*Image may vary slightly from actual product

Tools Required

Phillips Screwdriver
Flat Head Screwdriver
Power Drill
1/4" Drill Bit (for dry wall)
Pencil

Maintenance

Your new bath accessory is designed for years of trouble-free performance.

Keep it looking new by cleaning it periodically with a soft cloth. Avoid abrasive cleaners, steel wool, and harsh chemicals as these will dull the finish and void your warranty.

Contact Us

For Customer Service please call 877-319-3757, or go to homewerksww.com.

Instructions

51-10000 – Chrome robe hook
 51-15000 – Chrome paper holder
 51-17000 – Chrome towel ring
 51-18000 – Chrome 18" towel bar
 51-24000 – Chrome 24" towel bar

51-10000-BN – Chrome robe hook
 51-15000-BN – Chrome paper holder
 51-17000-BN – Chrome towel ring
 51-18000-BN – Chrome 18" towel bar
 51-24000-BN – Chrome 24" towel bar

51-10000-BB – Chrome robe hook
 51-15000-BB – Chrome paper holder
 51-17000-BB – Chrome towel ring
 51-18000-BB – Chrome 18" towel bar
 51-24000-BB – Chrome 24" towel bar



Bath Accessories

Preparation and Assembly *Images may vary slightly from actual product

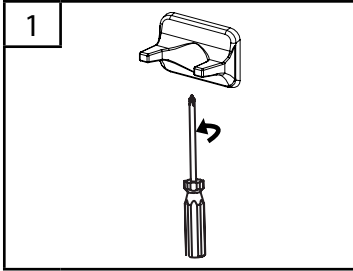

Determine desired location for your new bath accessories. Unscrew set screw at base of each post and remove mounting screws and brackets.

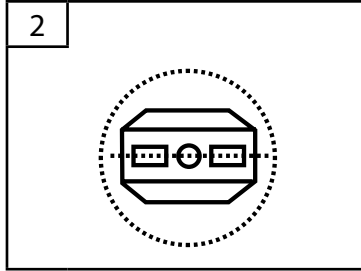

Determine desired location for your new bath accessories. Position base on wall where desired and lightly outline. Center mounting brackets horizontally in outline of posts.

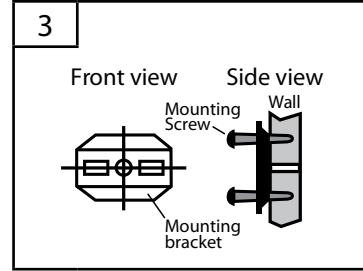

Drill 1/4" holes in drywall through the mounting screw holes. If attaching onto a wood wall, fasten mounting bracket directly to the wall with screws without pre-drilling the holes.

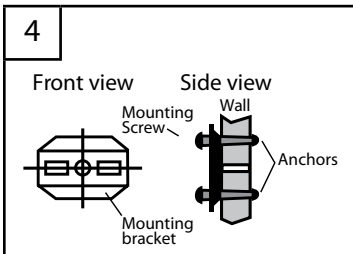

Push anchors into the drilled holes until flush with the wall surface. Fasten mounting bracket to the wall with mounting screws.

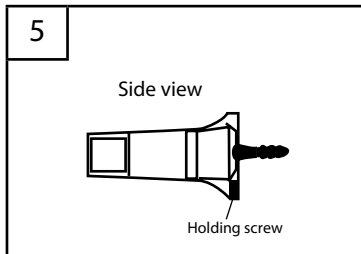

Place base over mounting bracket and tighten the holding screws.

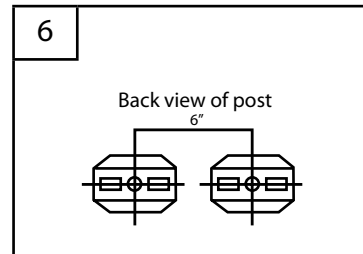

When installing tissue paper holder, center mounting brackets as shown.