

# boomchair™

interactive sound ... full tilt action

rounded  
bottom  
for  
multi-directional  
tilt

battery powered

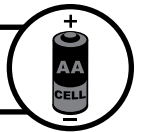

# Stingray

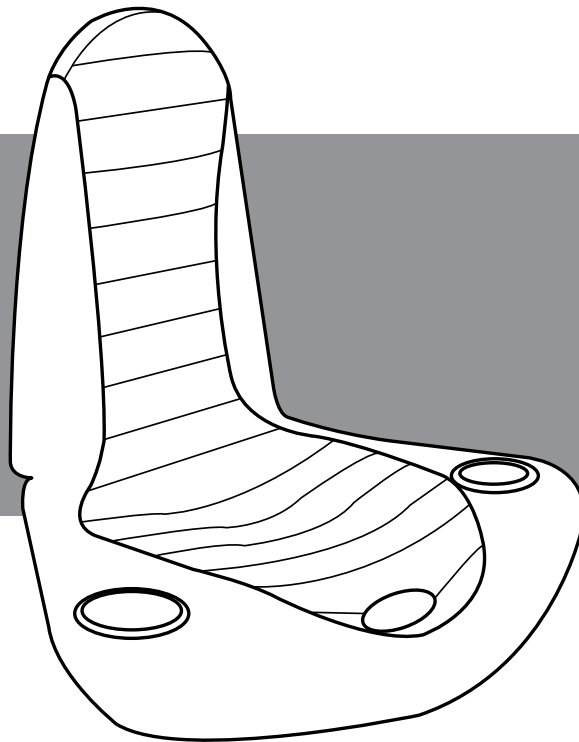

**LumiSource, Inc.**

# Stingray boomchair™



Congratulations!

You are now the proud owner of a BOOMCHAIR™. Prepare to experience your entertainment on a whole new level. BOOMCHAIR™ allows you to HEAR the sound and FEEL the excitement. You'll experience every crash, bang, and boom while enjoying your favorite game, music, or movie. BOOMCHAIR™ is also a great game seat built to endure the rigors of today's gaming environment. Take a moment to review your owner's manual before connecting your BOOMCHAIR™.

If you need further assistance visit us at [www.BoomChair.com](http://www.BoomChair.com) or [www.LumiSource.com](http://www.LumiSource.com)

BOOMCHAIR™, a LumiSource® product.  
LumiSource, Inc.  
2950 Old Higgins Road, Elk Grove Village, IL 60007

PATENTS PENDING

## CAUTIONS

### READ BEFORE USE

- DO NOT wash or soak with water. If BOOMCHAIR™ gets wet, disconnect power immediately and do not use until completely dry.
- Turn power off when not in use.
- Children under 5 years old should not use this product without parental supervision.
- For INDOOR use only/ DO NOT expose to direct sunlight, moisture, or extreme temperatures.
- DO NOT use on wood flooring, it may cause scratching.
- DO NOT use on slippery or uneven flooring.
- DO NOT Mix Old And New Batteries. Do Not Mix Alkaline, Standard (Carbon - Zinc), Or Rechargeable (Nickel - Cadmium) Batteries.
- To avoid explosion or leakage, do not dispose of batteries in a fire or attempt to recharge standard or alkaline batteries. Please dispose of batteries safely according to the battery manufacturers instructions or recycle battery per state and local codes. If battery leakage occurs and comes in contact with the skin or eyes, wash immediately with plenty of water. Batteries should be handled under adult supervision. If the device is not to be used for a long period of time, remove the batteries to prevent injury from possible battery leakage.
- Excessive exposure to audio equipment at high volume may lead to hearing loss.
- DO NOT Tamper with or open the product.

Caution: To reduce the risk of electric shock and fire, do not open the BOOMCHAIR™. There are no user serviceable parts inside. Refer to your warranty for service information.



*Internal*

### FCC part 15.21:

Warning: Changes or modifications to this unit not expressly approved by the party responsible for compliance could void the user's authority to operate the equipment.

### FCC WARNING

This device complies with Part 15 of the FCC rules.

Operation is subject to the following two conditions:

- (1) This device may not cause harmful interference.
- (2) This device must accept any interference received, including interference that may cause undesired operation.

## SET-UP GUIDE

The BOOMCHAIR™ comes with the following:

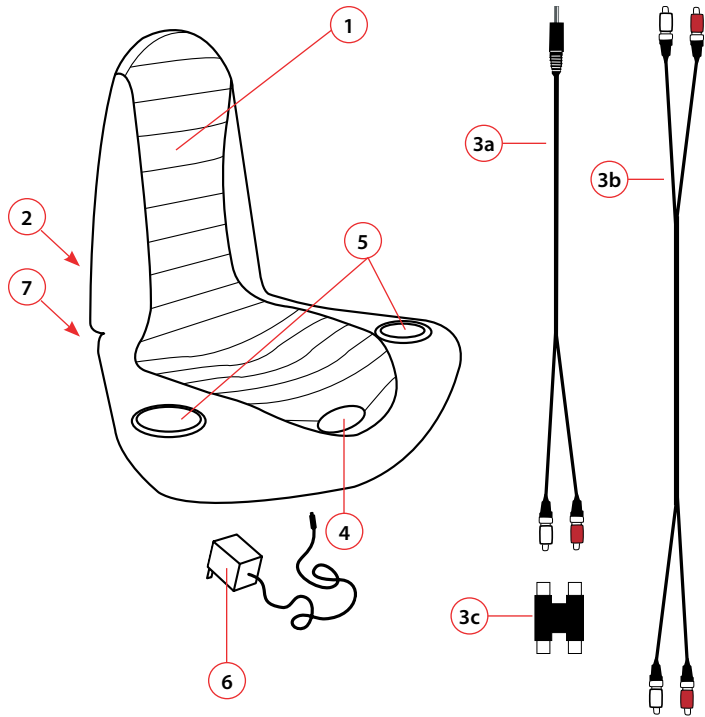

### PARTS LIST:

- 1) BOOMCHAIR™
- 2) BATTERY PACK (4 AA, not included)
- 3a) RCA TO MINI AUDIO CORD  
(headphone jack to audio left & right channel connectors)
- 3b) RCA CORD (audio left & right channel connectors)
- 3c) RCA AUDIO COUPLER
- 4) DASHBOARD CONTROL PANEL
- 5) 2x 3 in. (7.62 cm.) SPEAKERS (@ 3W 4 Ohms)
- 6) 6V AC POWER ADAPTER
- 7) HOOK AND LOOP FASTENERS

### SYSTEM SPECS:

Dimensions: 26.5 in. L x 22 in. W x 25 in. H  
67.3 cm. L x 56 cm. W x 63.5 cm. H

Weight: 25 lbs / 11.4 kgs.  
2 x 2.5 in. (7.62 cm) coaxial mid-high speakers @ 3W 4 Ohms

Power rating: 6 Volts at 500/mA

## DASHBOARD CONTROL PANEL

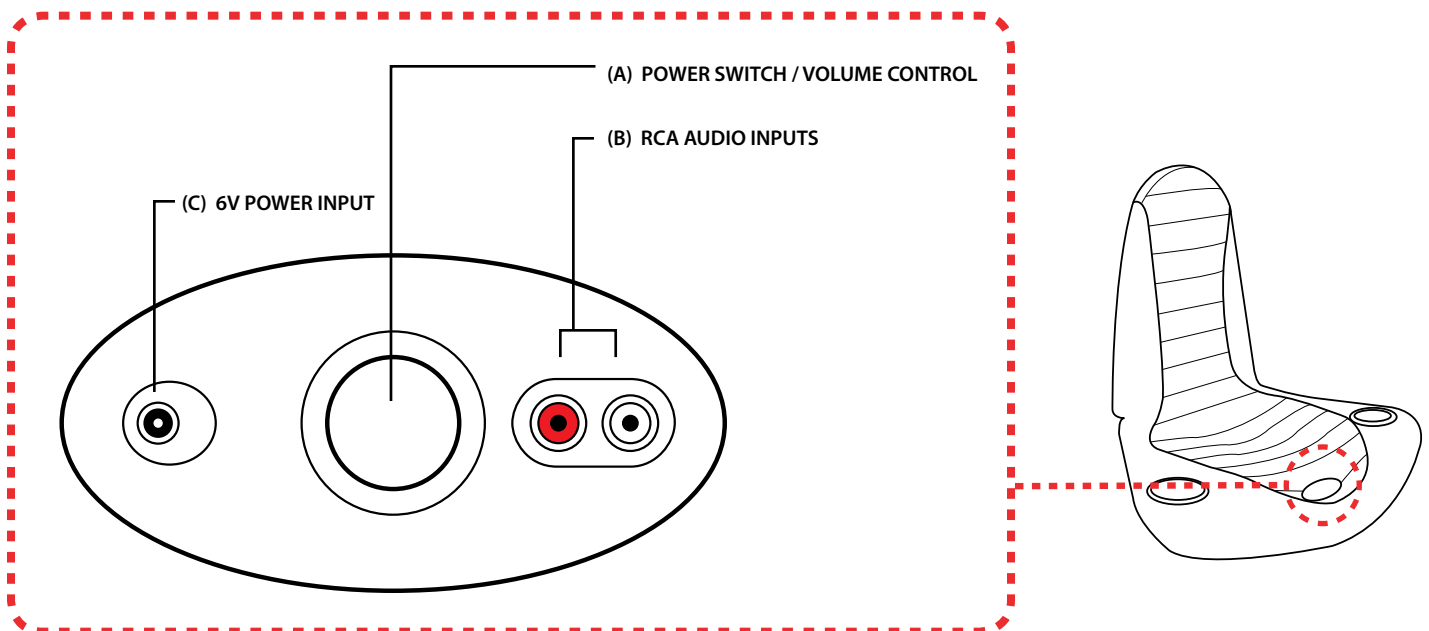

# ASSEMBLY INSTRUCTIONS

## BATTERY POWER OPTION

- Step 1: Unzip battery pocket on back of BOOMCHAIR™.
- Step 2: Open battery compartment.
- Step 3: Insert 4 "AA" cell batteries (not included).
- Step 4: Close battery compartment securely.
- Step 5: Place battery pack in pocket and zip closed.
- Step 6: Turn BOOMCHAIR™ on by turning Power knob (A) clockwise.

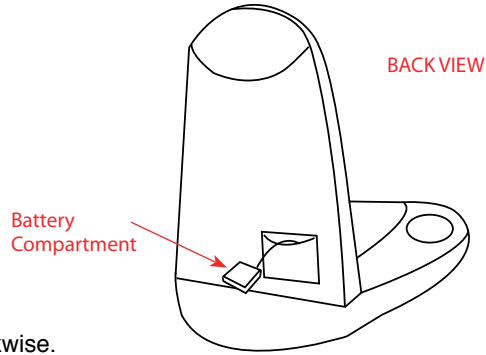

## DC POWER SUPPLY

- Step 1: Connect adaptor cord to DC power input (C) on Control Panel
- Step 2: Using included 6 Volt AC adaptor, plug adaptor to wall outlet.
- Step 3: Turn BOOMCHAIR™ on by turning Power knob (A) clockwise.

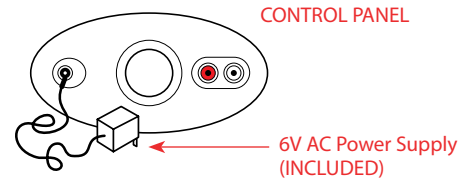

**CAUTION: Use ONLY 6 Volt AC adaptor! Different voltage may cause permanent damage to BOOMCHAIR™!**

# CONNECTING TO GAME CONSOLES

*Note: Most game consoles are supplied with a custom connector with yellow video out and RCA red/white audio out.*

- Step 1: Plug yellow composite video cable from game console into video input of TV. (Fig. 1)
- Step 2: Plug Red/White RCA cord from game console into RCA INPUT (B) of BOOMCHAIR™. (Fig. 2)

*Note: It may be necessary to extend your BOOMCHAIR™ further away from your TV or console. Here's how. (Fig.3)*

- Step 1: Connect Audio Coupler (3c) to Red/White RCA cord from game console.
- Step 2: Connect one end of RCA cord (3b) into other end of Audio Coupler (3c).
- Step 3: Connect other end of RCA cord (3b) into RCA INPUT (B) of BOOMCHAIR™.

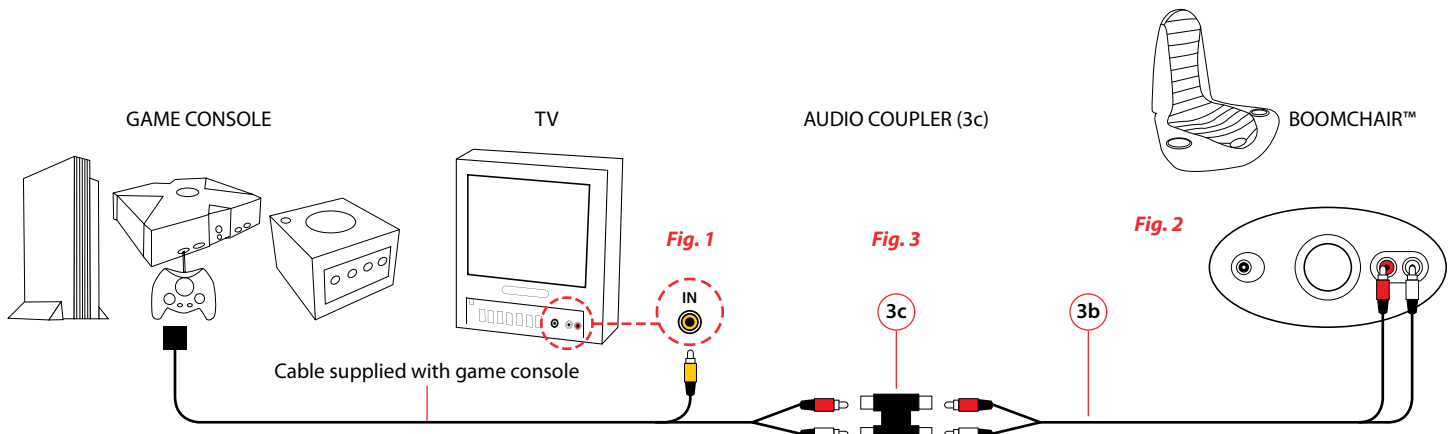

## CONNECTING TO PORTABLE AUDIO / VIDEO DEVICES

Step 1: Connect the Red/White ends of RCA cord (3a) into RCA INPUT (B) of BOOMCHAIR™.

Step 2: Plug the single end of the RCA cord (3a) into the headphone jack of your device.

Step 3: Turn BOOMCHAIR™ on by turning Power knob (A) clockwise.

Step 4: Turn portable device on.

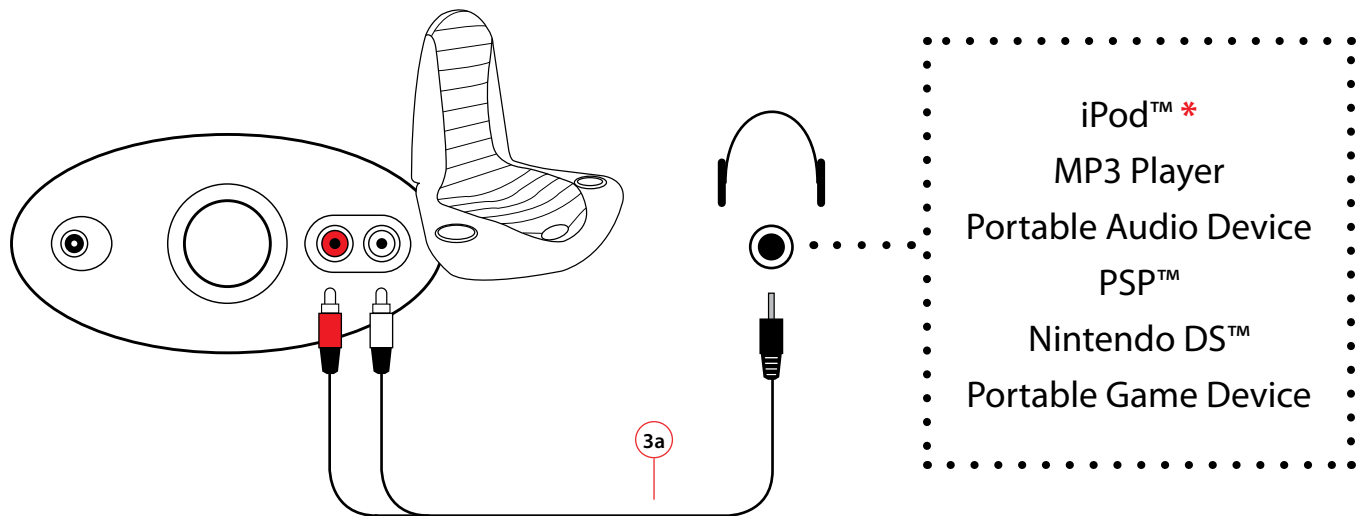

\* Note: Some Apple™ devices such as iPhone™ or iTouch™ require special 1/8 in. (3.5 mm) TTY adapter (sold separately)

## CONNECTING TO AUDIO / VIDEO DEVICES

Step 1: Connect the Red/White ends of RCA cord (3b) into RCA INPUT (B) of BOOMCHAIR™.

Step 2: Connect the other ends of RCA cord (3b) into AUDIO OUTPUT of Audio/Video device.

Step 3: Turn BOOMCHAIR™ on by turning Power knob (A) clockwise.

Step 4: Turn Audio/Video device on.

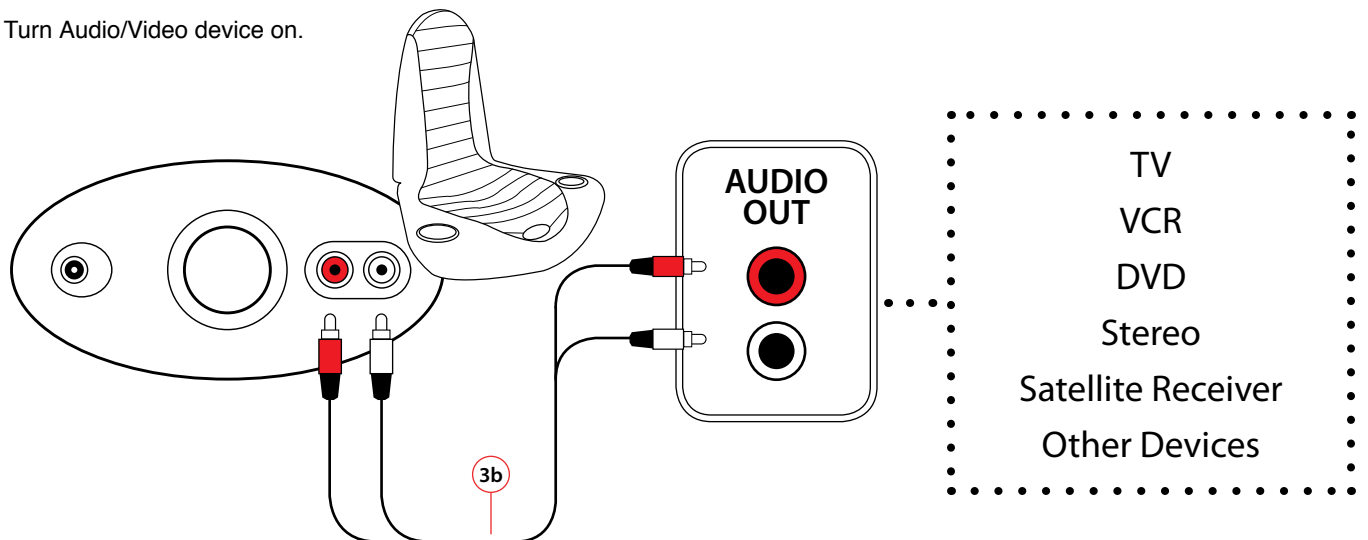

# DAISY CHAINING CHAIRS TOGETHER

Note: You will need two RCA “Y” adapters (sold separately) and two RCA cords (3b) to connect two BOOMCHAIRS™

Step 1: Connect single end of first “Y” adapter to RED RCA plug coming from media device. (Fig.1)

Step 2: Connect single end of second “Y” adapter to WHITE RCA plug coming from media device. (Fig.2)

Step 3: Cord A (Fig.3): Connect RED plug to RED “Y” adapter and WHITE plug to WHITE “Y” adapter. Separate cords as necessary. Connect opposite end of cord to INPUT of first BOOMCHAIR™.

Step 4: Cord B (Fig.4): Connect RED plug to RED “Y” adapter and WHITE plug to WHITE “Y” adapter. Separate cords as necessary. Connect opposite end of cord to INPUT of second BOOMCHAIR™.

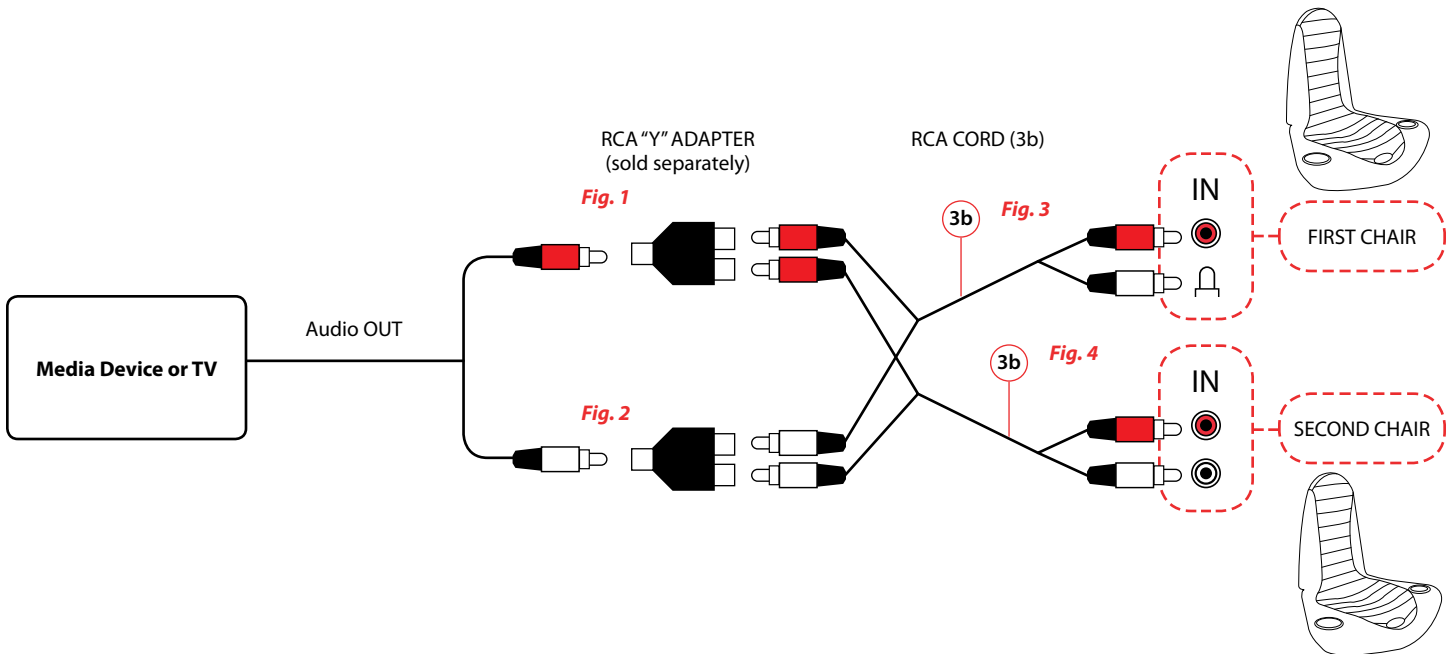

## TROUBLESHOOTING BOOMCHAIR™

Q: Why isn't there sound coming from any of my speakers?

A: Ensure your BOOMCHAIR™ is connected as described in the Setup Guide. Check that batteries are properly installed. Check that the power to the unit is on and the volume is turned up. Also, make sure your audio device is not set to "MUTE" and volume is turned up.

Q: Why isn't there sound coming from one of my speakers?

A: Ensure the audio cord to the BOOMCHAIR™ is securely connected as described in the Setup Guide. Make sure that both the left and right channel audio inputs are securely connected to the BOOMCHAIR™ and audio device.

Q: Where can I get more information?

A: Visit us at [www.BOOMCHAIR.com](http://www.BOOMCHAIR.com) or [www.LumiSource.com](http://www.LumiSource.com)

Contact information: LumiSource, Inc. 2950 Old Higgins Road, Elk Grove Village, IL 60007

E-mail: [customerservice@lumisource.com](mailto:customerservice@lumisource.com)

## MAINTENANCE AND REPAIR

If a problem occurs while using this product, please contact us. DO NOT open unit or attempt to repair on your own. It may result in serious injury from electric shock and void your product warranty.

## CLEANING/CARE INSTRUCTIONS

Fabric: Use a clean cloth to dab lightly with soap and water. DO NOT rub. DO NOT immerse in water. DO NOT use detergent.

## LUMISOURCE, INC. LIMITED WARRANTY

**LIMITED WARRANTY:** LumiSource, Inc. ("LumiSource") warrants this product against defects in materials and workmanship for a period of ninety (90) days from the date of original consumer purchase. If a covered warranty claim is timely made, LumiSource® will, at its sole discretion: (a) repair the product, using new and/or refurbished replacement parts or (b) replace the product with an identical (or comparable) product, without charge to you other than the initial shipping cost to return the product. LumiSource® will only pay return shipping charges for destinations within the 48 contiguous U.S.A., if the returned product is covered by the limited warranty.

**WHAT THIS WARRANTY DOES NOT COVER:** This warranty does not cover defects resulting from accidents, alterations, unauthorized repair, failure to follow instructions, misuse, commercial use, fire, flood, or acts of God.

**WHAT WE ASK YOU TO DO:** If there is a covered defect, please write or email us within 90 days of the date of purchase at the address noted on page 8 to obtain instructions and authorization to return the product to LumiSource®. You will need to pack the product securely in packaging providing at least the degree of protection of the original carton and packing materials and ship it to us at your expense. You will also need to include with the product (a) a copy of your original proof of purchase (retail receipt) showing the date of purchase and (b) a detailed explanation of the problem(s) requiring service.

TO THE EXTENT PERMITTED BY LAW, THIS LIMITED WARRANTY AND THE REMEDIES SET FORTH ABOVE ARE EXCLUSIVE AND IN LIEU OF ALL OTHER WARRANTIES, REMEDIES AND CONDITIONS, ORAL OR WRITTEN, EXPRESS OR IMPLIED. TO THE EXTENT PERMITTED BY LAW, LUMISOURCE® HEREBY DISCLAIMS ANY IMPLIED WARRANTIES, INCLUDING WITHOUT LIMITATION, WARRANTIES OF MERCHANTABILITY AND FITNESS FOR A PARTICULAR PURPOSE. TO THE EXTENT APPLICABLE STATE LAW EXCLUDES SUCH DISCLAIMERS, THEN TO THE EXTENT ALLOWED BY LAW, THE TIME FOR ANY CLAIMS FOR SUCH IMPLIED WARRANTIES SHALL EXPIRE 90 DAYS FROM THE DATE OF ORIGINAL CONSUMER PURCHASE. TO THE EXTENT PERMITTED BY LAW, LUMISOURCE® IS NOT RESPONSIBLE FOR DIRECT, SPECIAL, INCIDENTAL OR CONSEQUENTIAL DAMAGES, INCLUDING BUT NOT LIMITED TO LOSS OF TIME, INCONVENIENCE, LOSS OF USE OF YOUR PRODUCT, OR PERSONAL INJURY OR PROPERTY DAMAGE, CAUSED BY YOUR PRODUCT OR ITS FAILURE TO WORK.

This limited warranty gives you specific legal rights. Some states do not allow the exclusion or limitation of incidental or consequential damages, and applicable law may not permit the exclusion of certain implied warranties. You may also have other rights, which vary, from state to state.

**LumiSource, Inc.**

2950 Old Higgins Road, Elk Grove Village, IL 60007

E-mail: [customerservice@lumisource.com](mailto:customerservice@lumisource.com)

Phone: 1-888-461-5864 (toll free)

Phone: 1-847-699-8988 (international)

[www.BoomChair.com](http://www.BoomChair.com) • [www.LumiSource.com](http://www.LumiSource.com)

© 2008 LumiSource, Inc. All rights reserved. Boomchair™ STINGRAY™, the Boomchair™ logo, and Boomchair™ STINGRAY™ logo are trademarks of LumiSource Inc. Other trademarks are properties of their respective owners.

The design of this product is a trade dress of LumiSource, Inc. Patents pending. Actual contents may differ slightly from those pictured. Made in China.  
Distributed by LumiSource Inc., 2950 Old Higgins Road, Elk Grove Village, IL 60007. [www.lumisource.com](http://www.lumisource.com).

This product is not manufactured or distributed by Microsoft®, the owner of the trademark Xbox™; by Nintendo®, the owner of the trademark Wii™, GameCube™, and DS™; by Sony®, the owner of the trademarks Playstation™ PS3™, PS2™, and PSP™; or by Apple Computer, Inc., the owner of the trademark iPod™.